



# GASKETS:TRUCK/BUS



## CATALOGUE

**DAF IVECO MAN MERCEDES RENAULT SCANIA VOLVO**

# CERTIFICATE



**ISO/TS 16949  
: 2009**  
(with product design)

**TRUSTTEC<sup>®</sup>**



**TRUSTTEC<sup>®</sup> GASKETS ARE MADE FROM VARIETY OF RAW MATERIALS LIKE RUBBER , SILICONE, PAPER GASKETS, FIBER GLASS, PLASTIC POLYMER , CORK,FELT,METAL , GRAPHITE ETC.**

## C O N T E N T S

| PARTICULARS             | PAGE NOS. |
|-------------------------|-----------|
| <b>DAF</b>              |           |
| CYLINDER HEAD GASKET    | 01        |
| HEAD GASKET SET         | 01        |
| <b>IVECO</b>            |           |
| CYLINDER HEAD GASKET    | 01        |
| <b>MAN</b>              |           |
| CYLINDER HEAD GASKET    | 02        |
| HEAD GASKET SET         | 03        |
| OVERHAUL GASKET SET     | 04 - 06   |
| <b>MAN - TGA</b>        |           |
| CYLINDER HEAD GASKET    | 02 - 03   |
| HEAD GASKET SET         | 03        |
| <b>MERCEDES</b>         |           |
| CYLINDER HEAD GASKET    | 07 - 10   |
| EXHAUST MANIFOLD GASKET | 11 - 12   |
| EXHAUST PIPE GASKET     | 13        |
| INTAKE MANIFOLD GASKET  | 14        |
| VALVE COVER GASKET      | 15 - 16   |
| HEAD GASKET SET         | 17        |
| OVERHAUL GASKET SET     | 18 - 41   |
| <b>RENAULT</b>          |           |
| CYLINDER HEAD GASKET    | 42 - 44   |
| HEAD GASKET SET         | 42        |
| <b>SCANIA</b>           |           |
| CYLINDER HEAD GASKET    | 45 - 46   |
| HEAD GASKET SET         | 47 - 48   |
| OVERHAUL GASKET SET     | 49 - 56   |
| <b>VOLVO</b>            |           |
| CYLINDER HEAD GASKET    | 57 - 60   |
| HEAD GASKET SET         | 61 - 64   |
| BOTTOM GASKET SET       | 65 - 68   |
| OVERHAUL GASKET SET     | 72 - 76   |
| DECARBONIZING KIT       | 77 - 78   |
| EXHAUST MANIFOLD        | 79 - 80   |
| INTAKE MANIFOLD         | 81        |
| MANIFOLD GASKET KIT     | 82 - 83   |
| VALVE COVER GASKET      | 84 - 85   |
| WATER SEAL              | 85        |

\* OEM Part Numbers & other manufacturers Part Numbers have been used in this catalog for reference & information purpose only, & are not intended to infer that our replacement parts are used on original equipment.

Suitable for

## Cylinder Head Gasket

### DAF

TRUSTTEC NO. 035.01.0801

**OEM NO.**  
1320372/1366063-4  
1283752/0376729  
1298923

**OTHER NO.**  
61-27205-10,  
760.082,  
BW 470,  
300 265 90 10

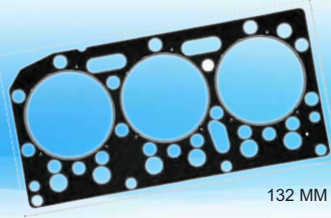

132 MM

| APPLICATION  | CYLINDER | CAPACITY | YEAR |
|--|----------|----------|------|
| F 95 XF 380, 430, 4806                             | 11600    | 1997 ON  |      |
| WS 1160/225/242/<br>259/268/268L/282/<br>295L/315L |          |          |      |

## Head Set Gasket

### DAF

TRUSTTEC NO. 035.01.0802

**OEM NO.**  
0682680,0683336

**OTHER NO.**  
02-27205-02,  
917.209

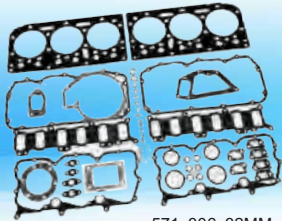

571x306x32MM

| APPLICATION  | CYLINDER | CAPACITY | YEAR |
|--|----------|----------|------|
| F 95 XF 380, 430, 4806                             | 11600    | 1987 ON  |      |
| WS 1160/225/242/259/<br>268/268L/282/295L/<br>315L |          |          |      |

## Cylinder Head Gasket

### IVECO

TRUSTTEC NO. 036.01.0801

**OEM NO.**  
61319085/61316613  
61316613

**OTHER NO.**  
61-33970-00,  
776.395,  
BS 350

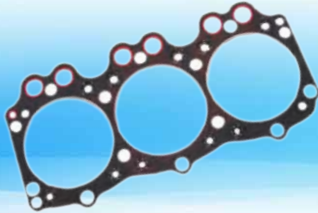

| APPLICATION  | CYLINDER | CAPACITY | YEAR    |
|--|----------|----------|---------|
| Eurostar,<br>Eurotech,<br>Euro Trakker,<br>Turbotech,<br>M175-24 T | 6        | 9500     | 1989 ON |

Suitable for

## Cylinder Head Gasket

### MAN

TRUSTTEC NO. 022.01.0801

**OEM NO.**  
51039010342/51039010262  
51039010268/51039010281  
51039010268/51039010281  
51039010252/51039010216  
51039010244/51039010246  
51039010227/51039010233  
51039010245

**OTHER NO.**  
61-25110-60,  
834.548



125MM

| APPLICATION    | CYLINDER | YEAR    |
|----------------|----------|---------|
| D 2555, D 2565 | 5        | 1972 ON |
| D 2556, D 2566 | 6        | 1972 ON |
| D 2538         | 8        | 1973 ON |
| D 2530, D 2540 | 10       | 1971 ON |
| D 2542         | 12       |         |

TRUSTTEC NO. 022.01.0802

**OEM NO.**  
51039010356/51039010015  
510390338/10139100  
51039010298  
442 016 0520/442 016 0320  
442 016 0520/442 016 0020  
442 016 0320/442 016 0020

**OTHER NO.**  
61-25275-00,  
451.690

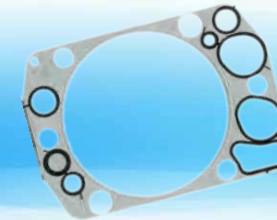

220.5x157.5x143.5x1.13MM

| APPLICATION    | CYLINDER | YEAR    |
|----------------|----------|---------|
| D 2865         | 5        |         |
| D 2866, D 2876 | 6        |         |
| D 2848         | 8        | 1976 ON |
| D 2840         | 10       | 1978 ON |
| D 2842         | 12       | 1976 ON |

TRUSTTEC NO. 022.01.0803

**OEM NO.**  
51039010268/51039010342  
51039010262/51039010281  
51039010252/51039010216  
51039010244/51039010246  
51039010227/51039010233  
51039010245

**OTHER NO.**  
61-25110-50



| APPLICATION    | CYLINDER | YEAR      |
|----------------|----------|-----------|
| D 2555, D 2565 | 5        |           |
| D 2556, D 2566 | 6        | 1974-1994 |
| D 2538         | 8        |           |
| D 2530         | 10       | 1971 ON   |
| D 2542         | 12       |           |

## Cylinder Head Gasket

### MAN TGA

TRUSTTEC NO. 022.01.0804

**OEM NO.**  
51039010338/51039010366  
51039010015/51039010356  
10139100

**OTHER NO.**  
829.722



218x184x2mm

| APPLICATION    | CYLINDER | YEAR  |
|----------------|----------|-------|
| D 2840, D 2530 | 10       | 15945 |
| D 2540         |          |       |
| D 2538, D 2848 | 8        | 12763 |
| D 2540         | 10       | 17426 |
| D 2542, D 2842 | 12       | 20911 |
| D 2840         | 10       | 18273 |
| D 2842         | 12       | 21927 |
| D 2848         | 8        | 14618 |
| D 2865         | 5        | 9973  |
| D 2866, D 2876 | 6        | 11967 |
| D 2876         | 6        | 12816 |

Suitable for

Cylinder Head Gasket

### MAN TGA

TRUSTTEC NO. 022.01.0805

**OEM NO.**

51039010382/51039010338  
51039010366/51039010015  
51039010356/10139100

**OTHER NO.**

099.980  
61-35145-00

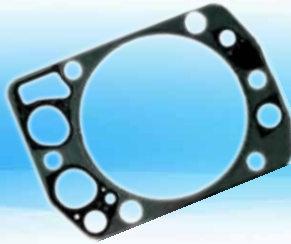

| APPLICATION                       | CYLINDER | YEAR  |
|-----------------------------------|----------|-------|
| MAN D 2866 / D 2876               |          |       |
| MAN E 2000                        |          | 05/00 |
| MAN F 2000                        |          | 06/98 |
| MAN TG-A 18/24/26/<br>33/35/37/40 |          | 09/02 |
| SCANIA 4 - series T 94/G 260      |          | 12/96 |

### Head Set Gasket

### MAN

TRUSTTEC NO. 022.01.0806

**OEM NO.**

51009006570/51009006437  
51009006231/51009006266  
51009006273/51009006280  
51009006349/51009006438  
51009006445/51009006448  
51009006230/51009006271  
51009006443

**OTHER NO.**

03-25110-01,  
286.711



| APPLICATION    | CYLINDER | YEAR    |
|----------------|----------|---------|
| D 2555, D 2565 | 5        | 1971 ON |
| D 2556, D 2566 | 6        | 1972 ON |
| D 2538         | 8        | 1973 ON |
| D 2530         | 10       | 1971 ON |
| D 2542         | 12       |         |

### MAN

TRUSTTEC NO. 022.01.0807

**OEM NO.**

51009006558/51009006536  
51009006552

**OTHER NO.**

03-25275-03



| APPLICATION    | CYLINDER | YEAR    |
|----------------|----------|---------|
| D 2865         | 5        |         |
| D 2866, D 2876 | 6        |         |
| D 2848         | 8        | 1979 ON |
| D 2840         | 10       | 1978 ON |
| D 2842         | 12       | 1976 ON |

### MAN TGA

TRUSTTEC NO. 022.01.0808

**OEM NO.**

51.00900.6630

**OTHER NO.**

296.770



Suitable for

Cylinder Head Gasket

### MAN TGA

TRUSTTEC NO. 022.01.0809

**OEM NO.**

51009006398

**OTHER NO.**

01-25275-07,  
518.346, 518.347

**APPLICATION**

D 2866,  
LH01/02, KH/KFZ/KOH,  
LFZ/LFZR, KF, LF02-10/14-17,  
TOH, OH, LFG / LXFG, LXF

**CYLINDER**

6

**CAPACITY**

11967

**YEAR**

1986-96



MAN

TRUSTTEC NO. 22.01.0810

| OEM NO.              | APPLICATION                     | CYLINDER | CAPACITY | YEAR    |
|----------------------|---------------------------------|----------|----------|---------|
| 51009006471          | D2566<br>MK / MKF /<br>MKH / MK | 6        | 11413    | 1979 ON |
| OTHER NO.<br>891.232 |                                 |          |          |         |

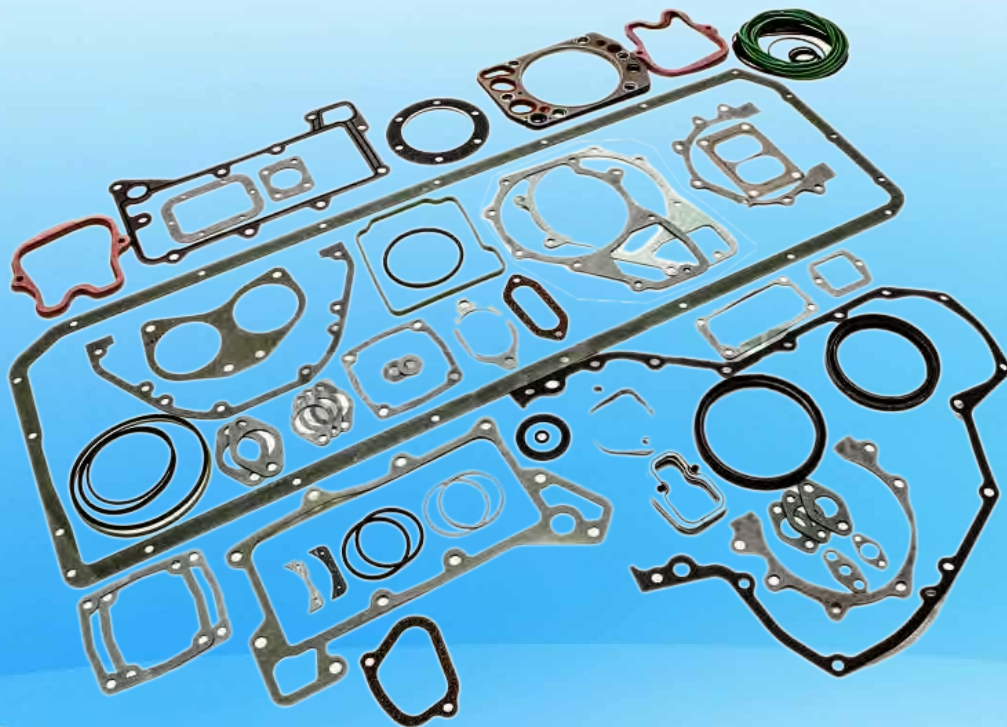

| WASHER & O-RING DETAILS-ORDER BY SIZE |      |  |
|---------------------------------------|------|--|
| Description                           | Qty. |  |
| G4-4129/1 SILICON RUB LIGH T GREEN    | 1    |  |
| G4-3527 NIGHT RUB BLACK               | 1    |  |
| G4-3528 NIGHT RUB BLACK               | 1    |  |
| G4-3529 NIGHT RUB BLACK               | 1    |  |
| G4-3530 NIGHT RUB BLACK               | 2    |  |
| G4-2946/5 NIGHT RUB BLACK COLOR       | 2    |  |
| G4-3531 NIGHT RUB BLACK COLOR         | 3    |  |
| G4-3532 NIGHT RUB BLACK COLOR         | 1    |  |
| G4-3533 SILICON RUB LIGHT GREEN       | 1    |  |
| G4-4013/1 VITON RUB LIGHT GREEN       | 12   |  |
| G4-4013/2 VITON RUB LIGHT GREEN       | 12   |  |

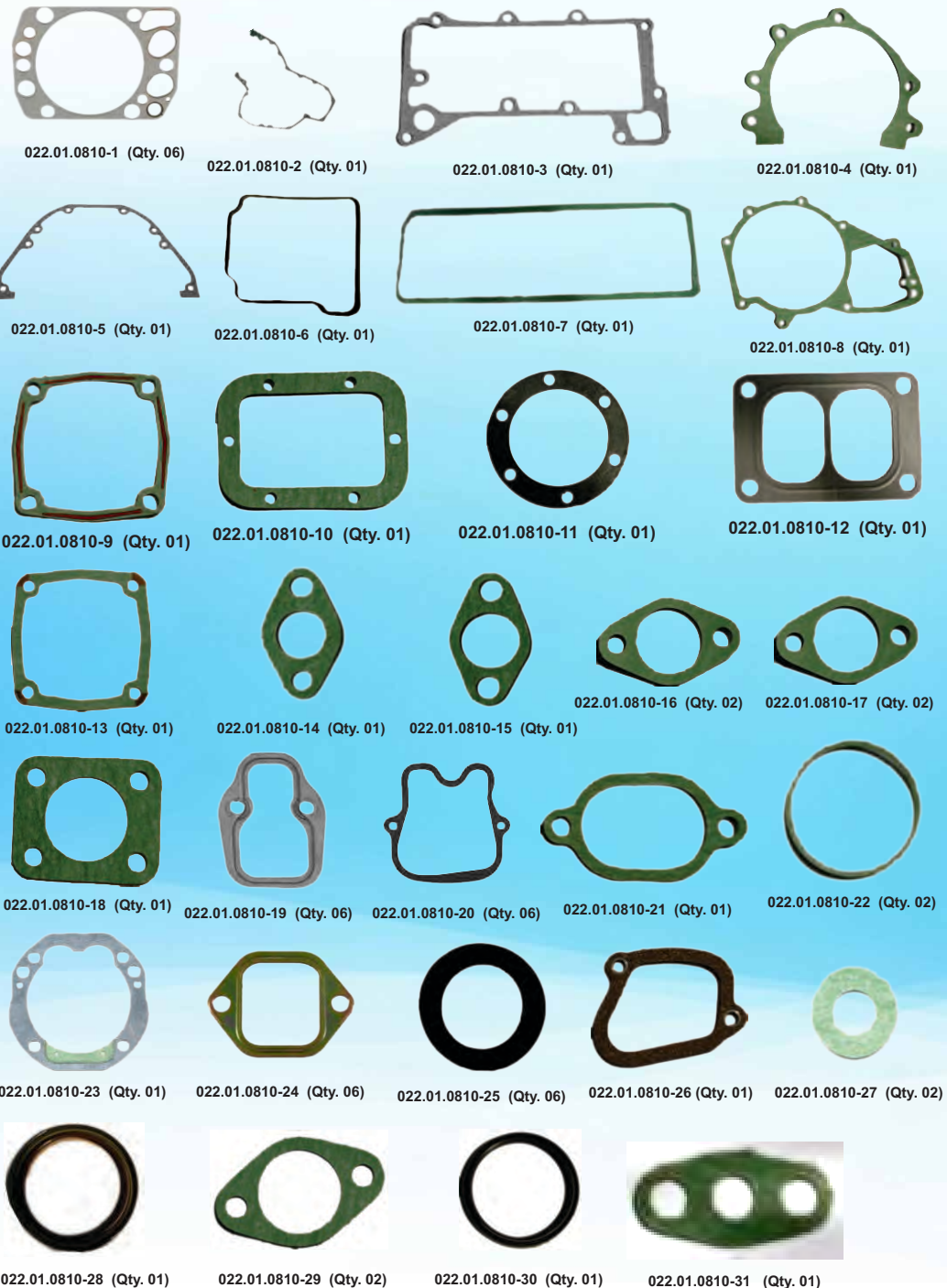

Suitable for

# Cylinder Head Gasket

## MERCEDES

TRUSTTEC NO. 01.01.0901

OEM NO.

314 016 07 20

OTHER NO.

089.176

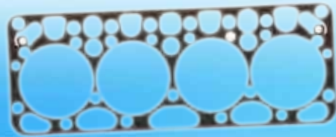

| APPLICATION | CYLINDER | CAPACITY | YEAR    |
|-------------|----------|----------|---------|
| OM 314      | 4        | 3784     | 1965 ON |

TRUSTTEC NO. 01.01.0902

OEM NO.

346 016 03 20

OTHER NO.

173.968



| APPLICATION  | CYLINDER | CAPACITY | YEAR    |
|--|----------|----------|---------|
| Om 346<br>MB 346.910-918<br>MB 346.941-946<br>MB 346.952-953 | 6        | 10809    | 1961 ON |

TRUSTTEC NO. 01.01.0903

OEM NO.

352 016 06 20  
352 016 07 20

OTHER NO.

089-184,  
AS 410

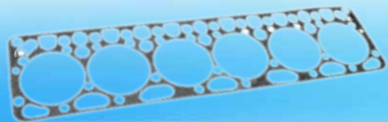

| APPLICATION                                | CYLINDER | CAPACITY | YEAR    |
|--|----------|----------|---------|
| OM 322, OM 352<br>OM 353, OM 363<br>OM 366 | 6        | 5675     | 1964 ON |

TRUSTTEC NO. 01.01.0904

OEM NO.

355 016 04 20

OTHER NO.

749.541



| APPLICATION    | CYLINDER | CAPACITY | YEAR    |
|----------------|----------|----------|---------|
| OM 346, OM 355 | 6        | 11580    | 1967 ON |

Suitable for

# Cylinder Head Gasket

## MERCEDES

TRUSTTEC NO. 01.01.0905

OEM NO.

460 016 04 20

OTHER NO.

61-37770-00,  
462.202

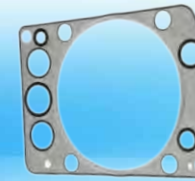

| APPLICATION                        | CYLINDER | CAPACITY | YEAR        |
|------------------------------------|----------|----------|-------------|
| OM 457 LA/<br>OM 457.937<br>OM 460 | 6        | 11967    | 01.02-10.04 |
| MERCEDES AXOR / AXOR 2             |          |          |             |

TRUSTTEC NO. 01.01.0906

OEM NO.

541 016 06 20  
541 016 09 20

OTHER NO.

61-34190-00,  
862.562



| APPLICATION     | CYLINDER | CAPACITY |
|-----------------|----------|----------|
| OM 541, OM 521, | 6        | 11946    |
| OM 542, OM 522, | 8        | 15928    |
| MERCEDES ACTROS |          |          |

TRUSTTEC NO. 01.01.0907

OEM NO.

541 016 13 20

OTHER NO.

61-37190-00  
066.720



| APPLICATION                    | CYLINDER | CAPACITY | YEAR  |
|--------------------------------|----------|----------|-------|
| MERCEDES ACTROS<br>MP 2 / MP 3 |          |          | 04/03 |

TRUSTTEC NO.01.01.0908

OEM NO.

904 016 13 20

OTHER NO.

61-36110-00,  
082.723, 082.724



| APPLICATION   | CYLINDER | CAPACITY | YEAR                                   |
|---|----------|----------|--|
| Om 904,<br>OM 904 LA,                               | 4        | 4250     |  |
| ATEGO<br>ATEGO 2<br>LK/LN2<br>VARIO 615/618/812/813 | 4        |          | 01/98-10/04<br>10/04<br>96/98<br>09/96 |

Suitable for

Cylinder Head Gasket

**MERCEDES**

TRUSTTEC NO. 01.01.0909

**OEM NO.**

422 016 02 20  
422 016 04 20  
422 016 06 20  
476 016 70 20

**OTHER NO.**

61-25105-55,  
748.080

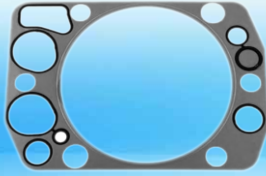

| APPLICATION                       | CYLINDER |
|-----------------------------------|----------|
| OM 401, OM 407,<br>OM 421, OM 427 | 6        |
| OM 402, OM 422,<br>OM 440         | 8        |
| OM 403, OM 423                    | 10       |

TRUSTTEC NO. 01.01.0910

**OEM NO.**

366 016 06 20

**OTHER NO.**

61-27350-40,  
760.678

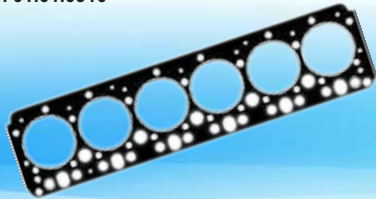

| APPLICATION   | CYLINDER | YEAR    |
|---|----------|---------|
| OM 352, OM 353,<br>OM 356, OM 357,<br>OM 362, OM 366,<br>OM 382 | 6        | 1984 ON |

TRUSTTEC NO. 01.01.0911

**OEM NO.**

442 016 00 20  
442 016 03 20

**OTHER NO.**

896.510,  
BG 850

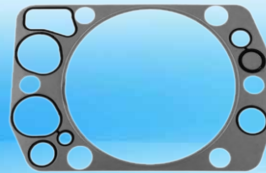

| APPLICATION   | CYLINDER |
|---|----------|
| OM 401, OM 407,<br>OM 421, OM 427,<br>OM 441, OM 445,<br>OM 447 | 6        |
| OM 402, OM 422,<br>OM 440, OM 442<br>OM 403, OM 423,<br>OM 443  | 8        |

TRUSTTEC NO. 01.01.0912

**OEM NO.**

457 016 11 20

**OTHER NO.**

61-34285-00,  
021.311

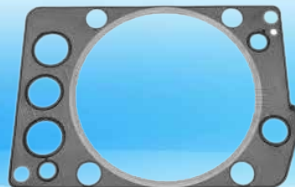

| APPLICATION | CYLINDER | CAPACITY | YEAR       |
|-------------|----------|----------|------------|
| Om 457      | 6        | 11967    | 2001/02 ON |

Suitable for

Cylinder Head Gasket

**MERCEDES**

TRUSTTEC NO. 01.01.0913

**OEM NO.**

906 016 11 20  
906 016 12 20  
906 016 14 20

**OTHER NO.**

61-36115-00,  
082.732  
082.733  
082.734

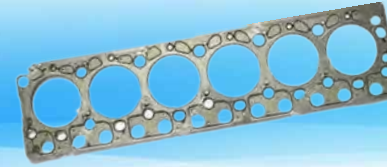

| APPLICATION              | CYLINDER | CAPACITY | YEAR                                |
|--------------------------|----------|----------|-------------------------------------|
| Om 906,<br>OM 906 LA     | 6        | 6374     |                                     |
| ATEGO<br>ATEGO 2<br>AXOR | 6        |          | 01/98-10/04<br>10/04<br>01/02-10/04 |

# Suitable for Exhaust Manifold Gasket

## MERCEDES

TRUSTTEC NO. 01.01.0914

| OEM NO.       | APPLICATION | CYLINDER | CAPACITY | YEAR    |
|---------------|-------------|----------|----------|---------|
| 314 142 03 80 | OM 314      | 4        | 3780     | 1965 ON |

**OTHER NO.**  
71-24030-10,  
108.367



TRUSTTEC NO. 01.01.0915

| OEM NO.       | APPLICATION     | CYLINDER | CAPACITY | YEAR    |
|---------------|-----------------|----------|----------|---------|
| 314 142 04 80 | OM 312, OM 352, | 6        | 5675     | 1964 ON |

**OTHER NO.**  
71-24004-10  
522.929



TRUSTTEC NO. 01.01.0916

| OEM NO.   | APPLICATION               | CYLINDER | CAPACITY | YEAR    |
|---|---------------------------|----------|----------|---------|
| 345 142 00 80<br>355 142 04 80<br>355 142 05 80 | OM 326, OM 346,<br>OM 355 | 6        | 11580    | 1967 ON |

**OTHER NO.**  
71-10447-60,  
558.192

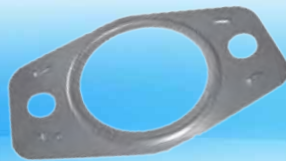

TRUSTTEC NO. 01.01.0917

| OEM NO.                                      | APPLICATION   | CYLINDER |
|--|---|----------|
| 403 142 03 80                                | OM 476, OM 401,<br>OM407,OM 421,<br>OM 441, OM 445,<br>OM 447 | 6        |
| <b>OTHER NO.</b><br>71-23079-00,<br>225.126, | OM 402, OM 422,<br>OM 440, OM 442,<br>OM 446                  | 8        |
|  | OM 403, OM 423<br>OM 443                                      | 10       |



# Suitable for Exhaust Manifold Gasket

## MERCEDES

TRUSTTEC NO. 01.01.0918

| OEM NO.                                     | APPLICATION   | CYLINDER |
|---|---|----------|
| 403 142 03 80                               | OM 476, OM 401,<br>OM 407, OM 421,<br>OM 441, OM 445,<br>OM 447 | 6        |
| <b>OTHER NO.</b><br>71-23079-00,<br>225.126 | OM 402, OM 422,<br>OM 440, OM 442,<br>OM 443                    | 10       |



TRUSTTEC NO. 01.01.0919

| OEM NO.       | APPLICATION    |
|---------------|----------------|
| 541 142 04 80 | OM 501, OM 502 |

**OTHER NO.**  
71-35327-00  
432.040

MERCEDES ACTROS

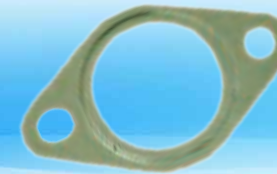

# Exhaust Pipe Gasket

TRUSTTEC NO. 01.01.0920

| OEM NO.                        | APPLICATION                       | CYLINDER | CAPACITY | YEAR    |
|--------------------------------|-----------------------------------|----------|----------|---------|
| 312 492 10 80<br>442 492 02 80 | OM 312, OM 352,<br>OM 353, OM 362 | 6        | 56       | 1964 ON |

**OTHER NO.**  
71-10534-10,  
020.907



TRUSTTEC NO. 01.01.0921

| OEM NO.       | APPLICATION                      | CYLINDER |
|---------------|----------------------------------|----------|
| 302 490 00 80 | OM 401, OM 402,<br>OM403,OM 404, | 6        |

**OTHER NO.**  
409.190



Suitable for

## Intake Manifold Gasket

### MERCEDES

TRUSTTEC NO. 01.01.0922

**OEM NO.**

355 141 02 80

**OTHER NO.**

71-20231-30,  
213.240



| APPLICATION    | CYLINDER | CAPACITY | YEAR    |
|----------------|----------|----------|---------|
| OM 346, OM 355 | 6        | 11580    | 1967 ON |

TRUSTTEC NO. 01.01.0923

**OEM NO.**

51.08902.0161,  
442 142 17 80  
442 141 18 80  
442 141 19 80

**OTHER NO.**

71-26069-20,  
896.365



| APPLICATION   | CYLINDER |
|---|----------|
| D 2555, D 2565, D 2865  | 5        |
| D 2556, D 2566, D 2866,<br>D 2876, E 2866, OM 401,<br>OM 407, OM 421, OM 427,<br>OM 441, OM 445, OM 447 | 6        |
| D 2538, OM 402, OM 422,<br>OM 440, OM 442, OM 466   | 8        |
| D 2530, D 2540, D 2840,<br>OM 403, OM 423, OM 443   | 10       |

TRUSTTEC NO. 01.01.0924

**OEM NO.**

51.08902.0161,  
442 141 17 80  
442 141 18 80  
442 141 19 80

**OTHER NO.**

71-26069-20,  
896.365



| APPLICATION   | CYLINDER |
|---|----------|
| D 2555, D 2565, D 2865  | 5        |
| D 2556, D 2566, D 2866,<br>D 2876, E 2866, OM 401,<br>OM 407, OM 421, OM 427,<br>OM 441, OM 445, OM 447 | 6        |
| D 2538, OM 402, OM 422,<br>OM 440, OM 442, OM 466   | 8        |
| D 2530, D 2540, D 2840,<br>OM 403, OM 423, OM 443   | 10       |

TRUSTTEC NO. 01.01.0925

**OEM NO.**

801 09804

**OTHER NO.**

71-34033-00,  
470.290



| APPLICATION     | CYLINDER |
|-----------------|----------|
| OM 521, OM 541, | 6        |
| OM 522, OM 542, | 8        |

Suitable for

## Valve Cover Gasket

### MERCEDES

TRUSTTEC NO. 01.01.0926

**OEM NO.**

314 016 03 21

**OTHER NO.**

71-20335-20,  
778.079

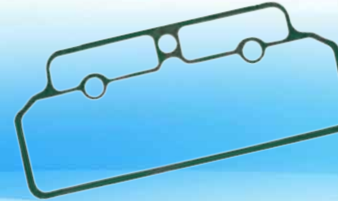

| APPLICATION                       | CYLINDER | CAPACITY | YEAR    |
|-----------------------------------|----------|----------|---------|
| OM 312, OM 352,<br>OM 353, OM 362 | 4        | 3780     | 1965 ON |

TRUSTTEC NO. 01.01.0927

**OEM NO.**

352 016 09 21

**OTHER NO.**

71-19137-40,  
777.773

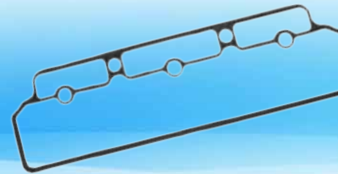

| APPLICATION                       | CYLINDER | CAPACITY | YEAR      |
|-----------------------------------|----------|----------|-----------|
| OM 312, OM 352,<br>OM 353, OM 362 | 6        | 5675     | 1957-1959 |

TRUSTTEC NO. 01.01.0928

**OEM NO.**

355 016 00 21

**OTHER NO.**

71-20041-30,  
775.525



| APPLICATION     | CYLINDER | CAPACITY | YEAR    |
|-----------------|----------|----------|---------|
| OM 346, OM 355, | 6        | 11580    | 1967 ON |

TRUSTTEC NO. 01.01.0929

**OEM NO.**

442 016 06 21  
442 016 07 21

**OTHER NO.**

71-23906-20,  
977.438



| APPLICATION  | CYLINDER |
|--|----------|
| M 476, OM 401,<br>OM 406, OM 421,<br>OM 427, OM 441,<br>OM 445, OM 447 | 6        |
| OM 402, OM 422,<br>OM 440, OM 442,<br>OM 448                           | 8        |
| OM 403, OM 423,<br>OM 443  | 10       |

Suitable for

## Valve Cover Gasket

### MERCEDES

TRUSTTEC NO. 01.01.0930

OEM NO.

366 016 03 21

OTHER NO.

71-26284-30,  
768.820

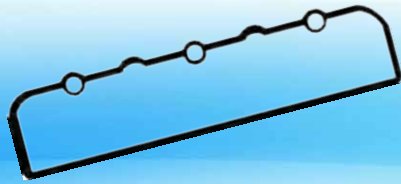

| APPLICATION     | CYLINDER | YEAR    |
|-----------------|----------|---------|
| OM 356, OM 357, | 6        | 1984 ON |

TRUSTTEC NO. 01.01.0931

OEM NO.

442 016 06 21  
442 016 07 21

OTHER NO.

71-21032-20,  
977.438



| APPLICATION   | CYLINDER |
|---|----------|
| OM 476, OM 401,<br>OM 406, OM 421,<br>OM 427, OM 441,<br>OM 445, OM 447 | 6        |
| OM 402, OM 422,<br>OM 440, OM 442,<br>OM 446                            | 8        |
| OM 403, OM 423,<br>OM 443   | 10       |

TRUSTTEC NO. 01.01.0932

OEM NO.

360 016 02 21

OTHER NO.

71-21032-20,  
777.766

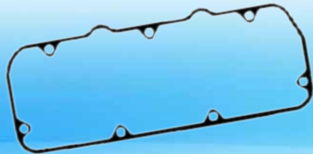

| APPLICATION    | CYLINDER |
|----------------|----------|
| OM 327, OM 360 | 6        |

TRUSTTEC NO. 01.01.0933

OEM NO.

541 016 03 21

OTHER NO.

71-33799-00,  
060.560



| APPLICATION                        | CYLINDER |
|------------------------------------|----------|
| OM 521, OM 541,<br>OM 522, OM 542, | 6<br>8   |
| MERCEDES ACTROS                    |          |

Suitable for

## Head Gasket Set

### MERCEDES

TRUSTTEC NO. 01.01.0934

OEM NO.

423 010 03 20

OTHER NO.

812.529

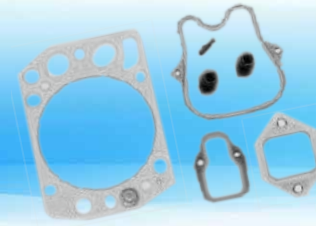

| APPLICATION  | CYLINDER |
|--|----------|
| OM 401, OM 407,<br>OM 421, OM 441,<br>OM 402, OM 447 | 6        |
| OM 402, OM 442,<br>OM 440, OM 442,<br>OM 446         | 8        |
| OM 403, OM 423,<br>OM 443                            | 10       |

TRUSTTEC NO. 01.01.0935

OEM NO.

444 010 01 20

OTHER NO.

03-25105-08,  
413.810

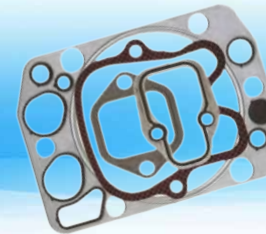

| APPLICATION   | CYLINDER |
|---|----------|
| OM 401, OM 407,<br>OM 421, OM 427,<br>OM 441, OM 445,<br>OM 447 | 6        |
| OM 402, OM 422,<br>OM 440, OM 442,<br>OM 446                    | 8        |
| OM 403, OM 423,<br>OM 443                                       | 10       |

TRUSTTEC NO. 01.01.0936

OEM NO.

541 010 25 20

OTHER NO.

03-34190-02,  
711.442

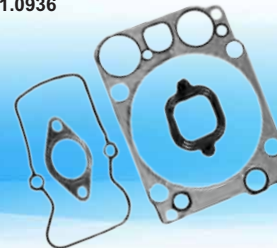

| APPLICATION                        | CYLINDER | CAPACITY | YEAR    |
|------------------------------------|----------|----------|---------|
| OM 521, OM 541,<br>OM 522, OM 542, | 6<br>8   | 11946    | 1997 ON |
| MERCEDES ACTROS                    |          |          |         |

TRUSTTEC NO. 01.01.0937

OEM NO.

457 010 31 20  
457 010 73 20

OTHER NO.

03-34285-01  
712.541



| APPLICATION | CYLINDER | CAPACITY | YEAR     |
|-------------|----------|----------|----------|
| OM 457      |          | 11967    | 01/02 ON |

MERCEDES

TRUSTTEC NO. 01.01.0938

OEM NO. APPLICATION CYLINDER CAPACITY YEAR  
 314 586 5190 OM 314 4 3780 1965 ON

OTHER NO.  
 825.913

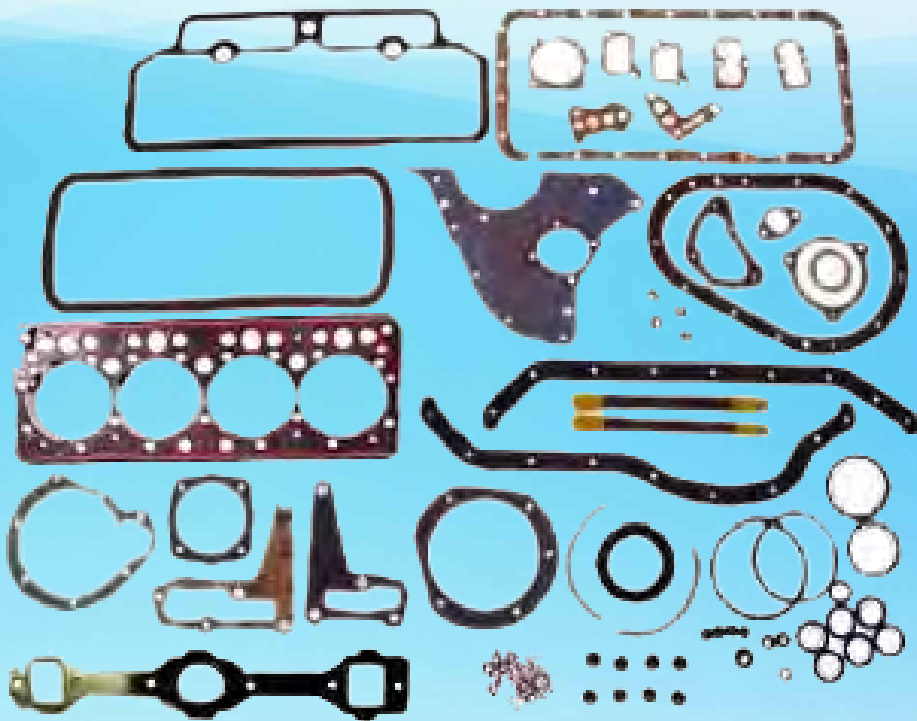

| WASHER & O-RING DETAILS-ORDER BY SIZE    |      |  |
|--|------|--|
| Description                              | Qty. |  |
| CU WASHER 16 X 20 MM ' 1.5               | 1    |  |
| CU WASHER 6 X 10 MM ' 0.9                | 2    |  |
| G4-2476 ASB GLAND PACKING                | 2    |  |
| CU WASHER 18 X 22 MM ' 1.6               | 12   |  |
| 32.5X37.7X2.6 MM CU+ASB WASHER,22045WN01 | 1    |  |
| AL WASHER 20 X 24 MM ' 1.5               | 1    |  |
| CU WASHER 12.5 X 15.5 MM ' 1.5           | 2    |  |
| AL WASHER 22 X 27 MM ' 1.6               | 3    |  |
| 24X32 MM CU+ASB WASHER,22045WM01         | 2    |  |
| CU WASHER 9.5 X 20 MM ' 1                | 2    |  |
| CU WASHER 20 X 24 MM ' 1.6               | 1    |  |
| CU WASHER 24 X 29 MM ' 2                 | 1    |  |
| AL WASHER 12 X 15.5 MM ' 1.5             | 1    |  |
| AL WASHER 14 X 18 MM ' 1.6               | 5    |  |
| CRCA WASHER 22.2 X 28.8 MM ' 1.6         | 1    |  |
| CU WSR 22X27 22052W020 ' 1.6             | 1    |  |
| AL WASHER 10 X 13.5 MM ' 1               | 2    |  |

| WASHER & O-RING DETAILS-ORDER BY SIZE |      |  |
|---------------------------------------|------|--|
| Description                           | Qty. |  |
| AL WASHER 16 X 22 MM ' 1.5            | 2    |  |
| CU WASHER 11.4 X 8 MM BANCO NO : ' 1  | 2    |  |
| CU WASHER 8X12A MM 220 62 W170 ' 0.9  | 4    |  |
| G5-1908 HNR                           | 1    |  |
| CU WSR 18X24 22052W010 ' 1.6          | 1    |  |
| MS WASHER 14 X 18 ' 1.6               | 1    |  |
| CU WASHER 8 X 12 MM ' 0.9             | 3    |  |
| AL WASHER 14X20 MM 220 62 W060 ' 1.6  | 12   |  |
| CU WASHER 8,0 X 14,0 MM ' 1           | 4    |  |
| AL WASHER 22.2 X 28,3 MM ' 1.5        | 4    |  |
| G5-1428 HNB                           | 1    |  |
| 22.4X26.8 MM CU+ASB WASHER,22069WS01  | 2    |  |
| AL WASHER 18 X 22 MM ' 2              | 2    |  |
| AL WASHER 26 X 32 MM ' 2              | 1    |  |
| CU WASHER 26 X 32 MM ' 1.6            | 1    |  |
| AL WASHER 26 X 31 MM ' 2              | 1    |  |
| CU WASHER 10 X 13.5 MM ' 0.9          | 7    |  |

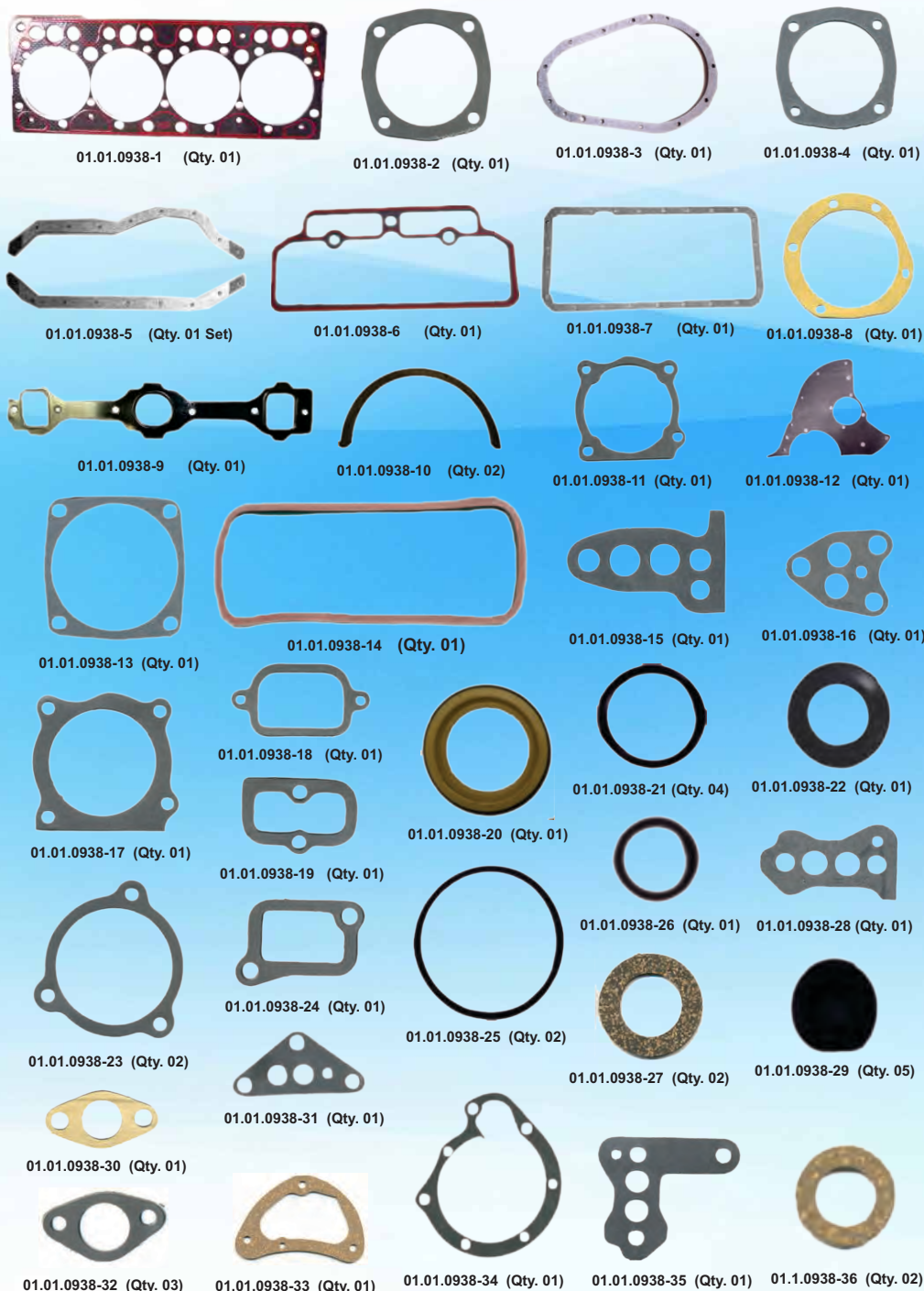

MERCEDES

TRUSTTEC NO. 01.01.0939

OEM NO. APPLICATION CYLINDER CAPACITY YEAR  
 352 586 02 90 OM 352 6 5680 1964 ON

OTHER NO.  
 826.871

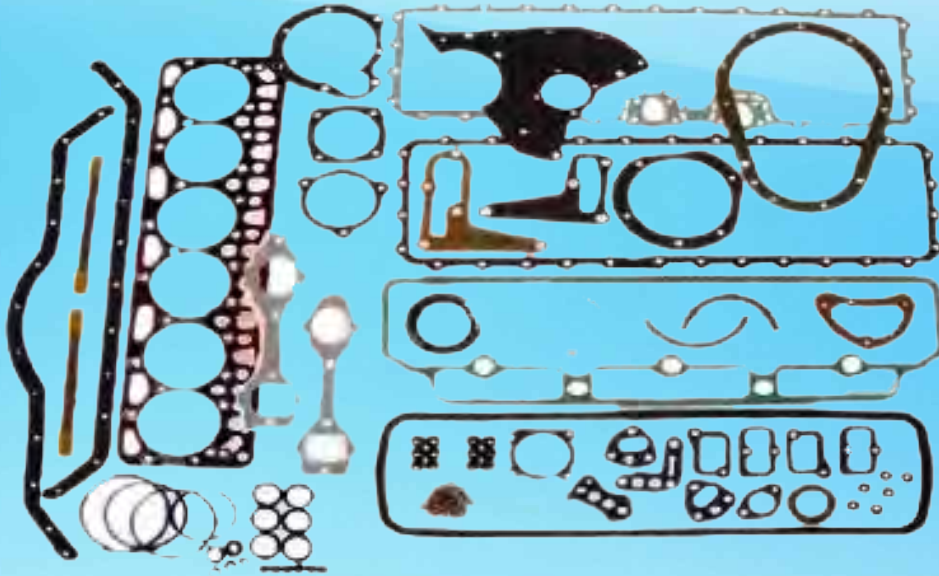

| O-RING DETAILS- ORDER BY SIZE          |     |  |
|--|-----|--|
| Description                            | Qty |  |
| G5-1428 HNB                            | 1   |  |
| G4-1435 ANB                            | 1   |  |
| G4-1436                                | 1   |  |
| G5-1437 ANB                            | 6   |  |
| G5-1439 ASB                            | 1   |  |
| G4-1441 BNB                            | 1   |  |
| G5-1442 BNB                            | 3   |  |
| G4-1425 GNB                            | 1   |  |
| G5-1427 CNB                            | 4   |  |
| G4-2476 ASB GLAND PACKING              | 2   |  |
| G4-417 BNB (ISSUE-4)                   | 7   |  |
| G4-1440 ANB                            | 1   |  |
| G5-1438 ANB                            | 1   |  |
| CU WASHER 24 X 29 MM ' 2               | 1   |  |
| 24X32 MM CU+ASB WASHER,22045WM01       | 1   |  |
| AL WASHER 26 X 32 MM ' 2               | 1   |  |
| FINAL PLAN 220 69 WN 0.18 CU/ASB 32X38 | 1   |  |
| CU WASHER 9.5 X 20 MM ' 1              | 6   |  |

| WASHER DETAILS-ORDER BY SIZE           |     |  |
|--|-----|--|
| Description                            | Qty |  |
| RF WASHER 10 X 16 MM ' 1               | 11  |  |
| CU WASHER 8X12A MM 220 62 W170 ' 0.9   | 6   |  |
| MS WASHER 8.0 X 12.0 MM ' 1            | 12  |  |
| CU WASHER 6 X 10 MM ' 0.9              | 2   |  |
| CU WASHER 8 X 11.5 MM ' 0.9            | 2   |  |
| CU WASHER 8.0 X 14.0 MM ' 1            | 7   |  |
| CU WASHER 10 X 13.5 MM ' 0.9           | 9   |  |
| CU WASHER 10 X 15 MM ' 1.6             | 2   |  |
| AL WASHER 12 X 15.5 MM ' 1.5           | 1   |  |
| FINAL PLAN 220 69 W0 0.18 CU/ASB 14X18 | 5   |  |
| CU WASHER 14 X 18 MM ' 1.5             | 9   |  |
| MS WASHER 14 X 18 ' 1.6                | 11  |  |
| AL WASHER 14 X 18 MM ' 1.6             | 5   |  |
| AL WASHER 14X20 MM 220 62 W060 ' 1.6   | 3   |  |
| CU WASHER 16 X 20 MM ' 1.5             | 2   |  |
| CU WASHER 16 X 20.5 MM ' 0.7           | 1   |  |
| AL WASHER 16 X 22 MM ' 1.5             | 2   |  |
| CU WASHER 18 X 22 MM ' 1.6             | 5   |  |
| AL WASHER 18 X 22 MM ' 1.6             | 11  |  |
| CU WSR 18X24 22052W010 ' 1.6           | 1   |  |
| FINAL PLAN 220 69 WP 0.18 CU/ASB 22X27 | 2   |  |
| AL WASHER 22 X 27 MM ' 1.6             | 1   |  |

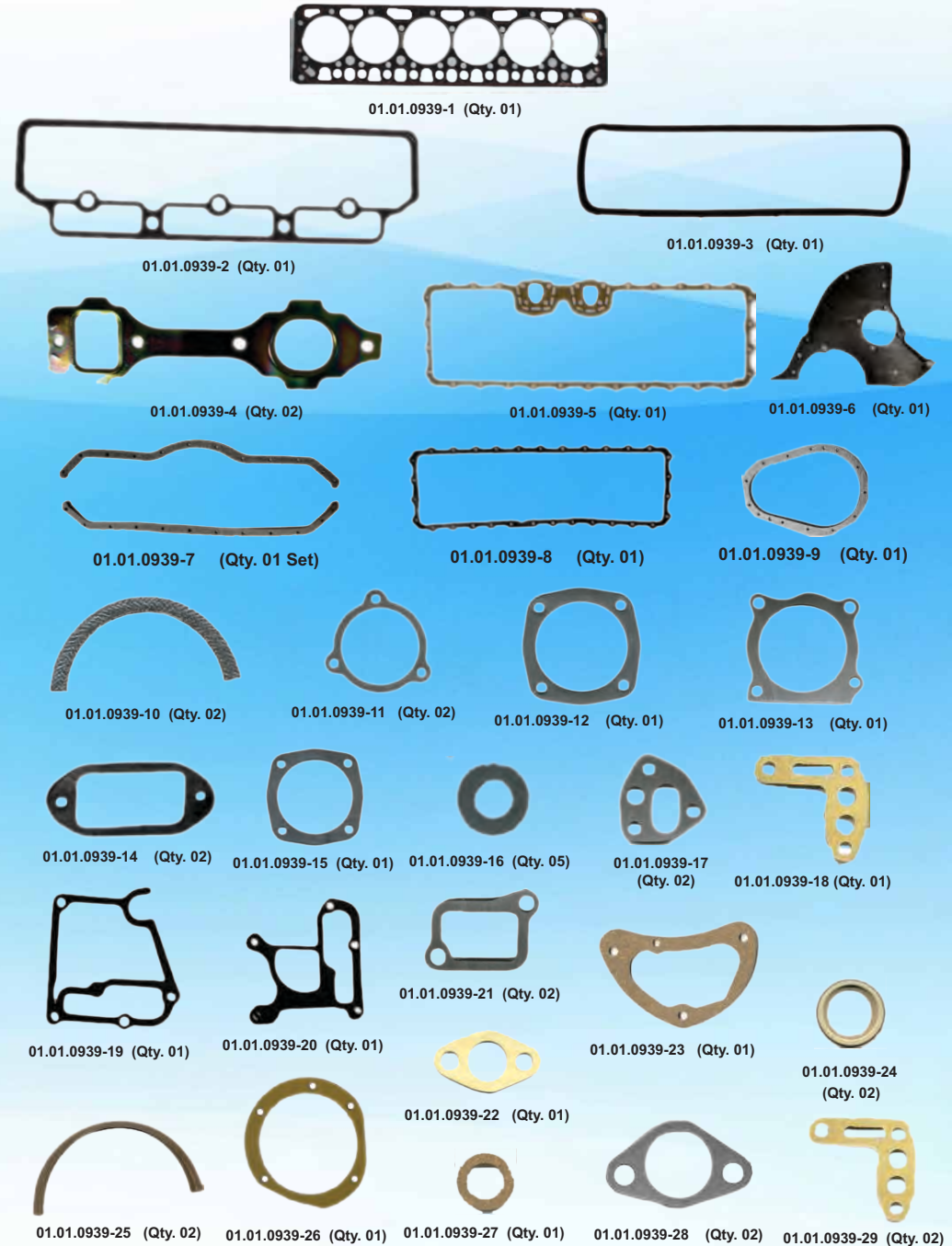

MERCEDES

TRUSTTEC NO. 01.01.0940

OEM NO. APPLICATION CYLINDER CAPACITY YEAR  
 355 586 03 90 OM 346, OM 355 6 11580 1967 ON

OTHER NO.  
 701.760

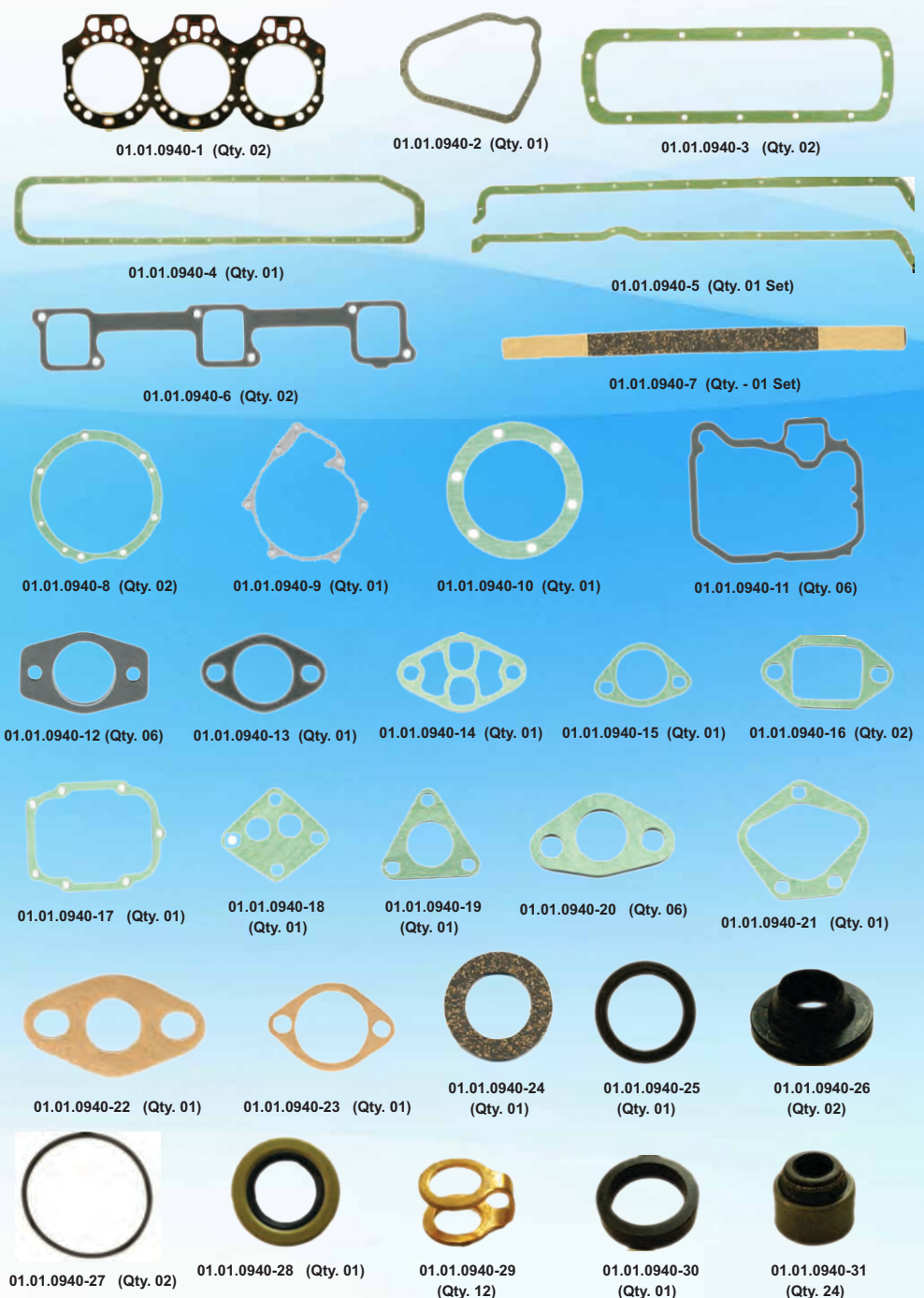
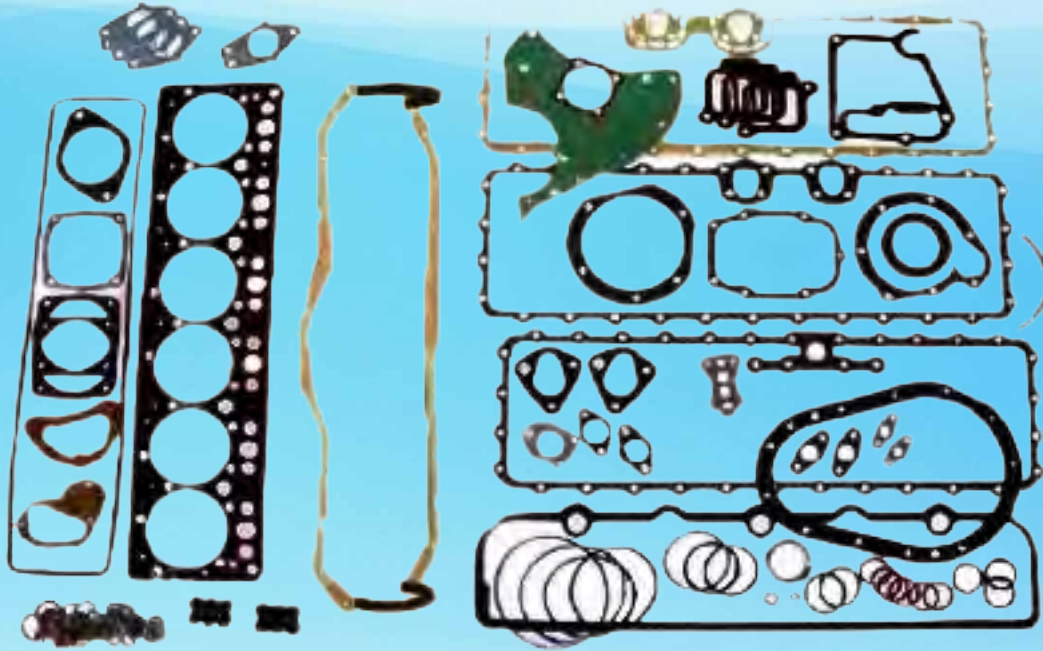

WASHER & O-RING DETAILS-ORDER BY SIZE

| Description        | Qty. |
|--------------------|------|
| 15.3 X 12.3        | 6    |
| 13.80 X 8.3        | 2    |
| 11.30 X 8.3        | 2    |
| 9.8 X 6.3          | 2    |
| 41 X 35.5 X 20     | 7    |
| 36 X 30 X 1.80     | 2    |
| 26.3 X 30.50       | 1    |
| 28.8 X 24.0        | 2    |
| 26.9 X 22.50       | 6    |
| 25.9 X 20.50       | 2    |
| 21.8 X 18.4        | 4    |
| 21.8 X 16.4 X 1.30 | 2    |
| 20 X 14.5 X 1.30   | 12   |
| 20.2 X 9.6 X 1.0   | 6    |
| 13.8 X 8.3 X 1     | 18   |

WASHER & O-RING DETAILS-ORDER BY SIZE

| Description          | Qty. |
|----------------------|------|
| 14.5 X 17.7          | 1    |
| 8 X 12 A             | 12   |
| 6.3 X 11.3 X 0.8     | 13   |
| 19.8 X 16.4 X 1.35   | 1    |
| 19.8 X 14.30 X 1.45  | 7    |
| 14.4 X 17.9 X 1.35   | 2    |
| 14.5 X 17.7          | 3    |
| 14.4 X 18 X 1.35     | 1    |
| Silicon Rubber Black | 1    |
| Silicon Rubber Black | 6    |
| Nitrial Rubber Black | 2    |
| Silicon Rubber Black | 1    |
| Silicon Rubber Black | 1    |

MERCEDES

TRUSTTEC NO. 01.01.0941

OEM NO. APPLICATION CYLINDER CAPACITY YEAR  
 366 010 61 20 OM 366 5960 1984 ON

OTHER NO.  
 02-27350-04,  
 826.750

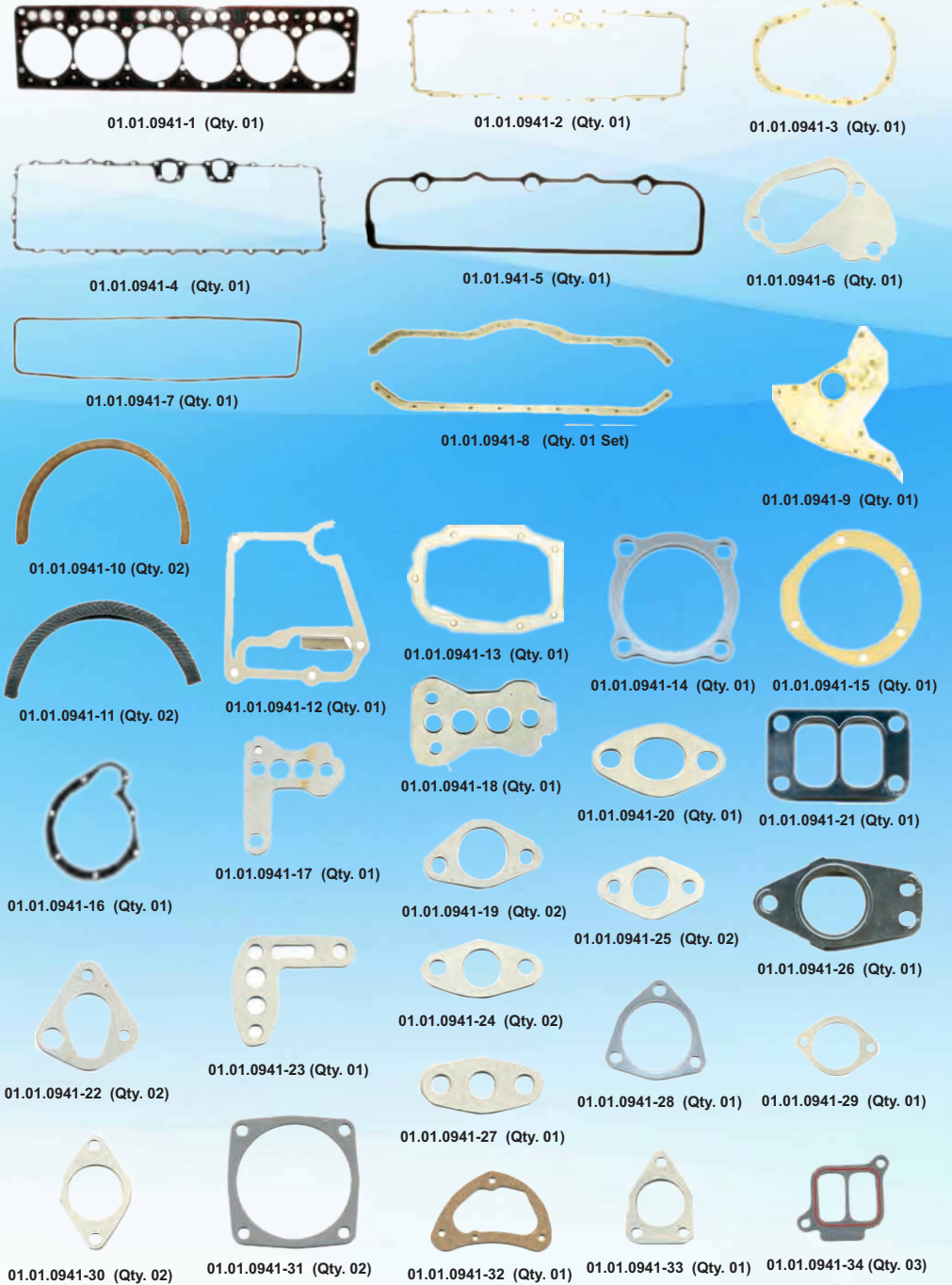
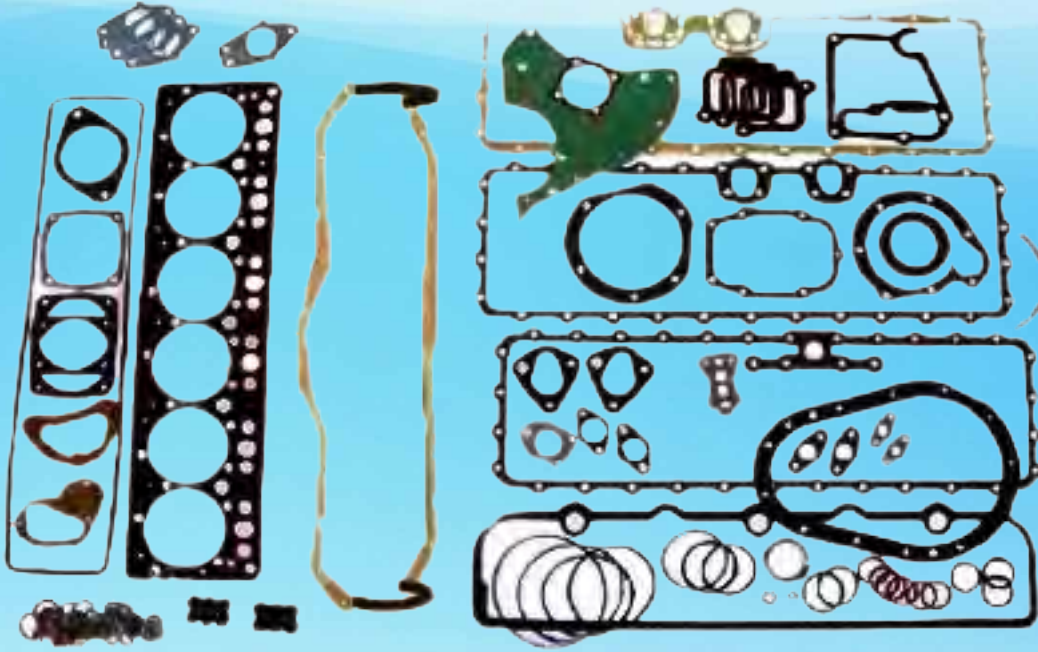

WASHER & O-RING DETAILS-ORDER BY SIZE

| Description                    | Qty. |
|--------------------------------|------|
| G43920/1CUWASHER35.8X30.35X1.8 | 1    |
| G43920/2CUWASHER31.8X26.2X1.8  | 1    |
| G4-3920/3ALWASHER19.8X14.2X1.4 | 15   |
| G43920/4CUWASHER21.8X18.35X1.3 | 7    |
| 14.3X17.8CUWASHERAG3-3512/23   | 13   |
| G43920/5CU WASHER19.8X9.5X1.0  | 6    |
| G4-3919CU WASHER 12X8X1.0      | 6    |
| G43920/6CUWASHER26.8X22X1.3    | 2    |
| G43920/7CUWASHER19.8X14.35X1.3 | 3    |

WASHER & O-RING DETAILS-ORDER BY SIZE

| Description                    | Qty. |
|--------------------------------|------|
| G43920/8CU WASHER13.5X8.5X0.8  | 6    |
| G43920/9CU WASHER11.5X8.35X0.8 | 13   |
| G4-3904/1 SILICON RUB          | 1    |
| G4-3904/2SILICON RUBBER O RING | 1    |
| G4-3904/3SILICONRUBBER O RING  | 2    |
| G4-3905SILICON RUBBER SEAL     | 1    |
| G4-3096/3 NIT.BLACK            | 2    |
| G4-3904/4SILICON RUBBER O RING | 6    |
| G4-3909 SILICONRUBBER SEAL     | 7    |

MERCEDES

TRUSTTEC NO. 01.01.0942

| OEM NO.      | APPLICATION             | CYLINDER | CAPACITY | YEAR      |
|--------------|-------------------------|----------|----------|-----------|
| 403 586 5190 | OM 422 A<br>OM 422 A/LA | 8        | 14618    | 1973 - 96 |

OTHER NO.  
826.642

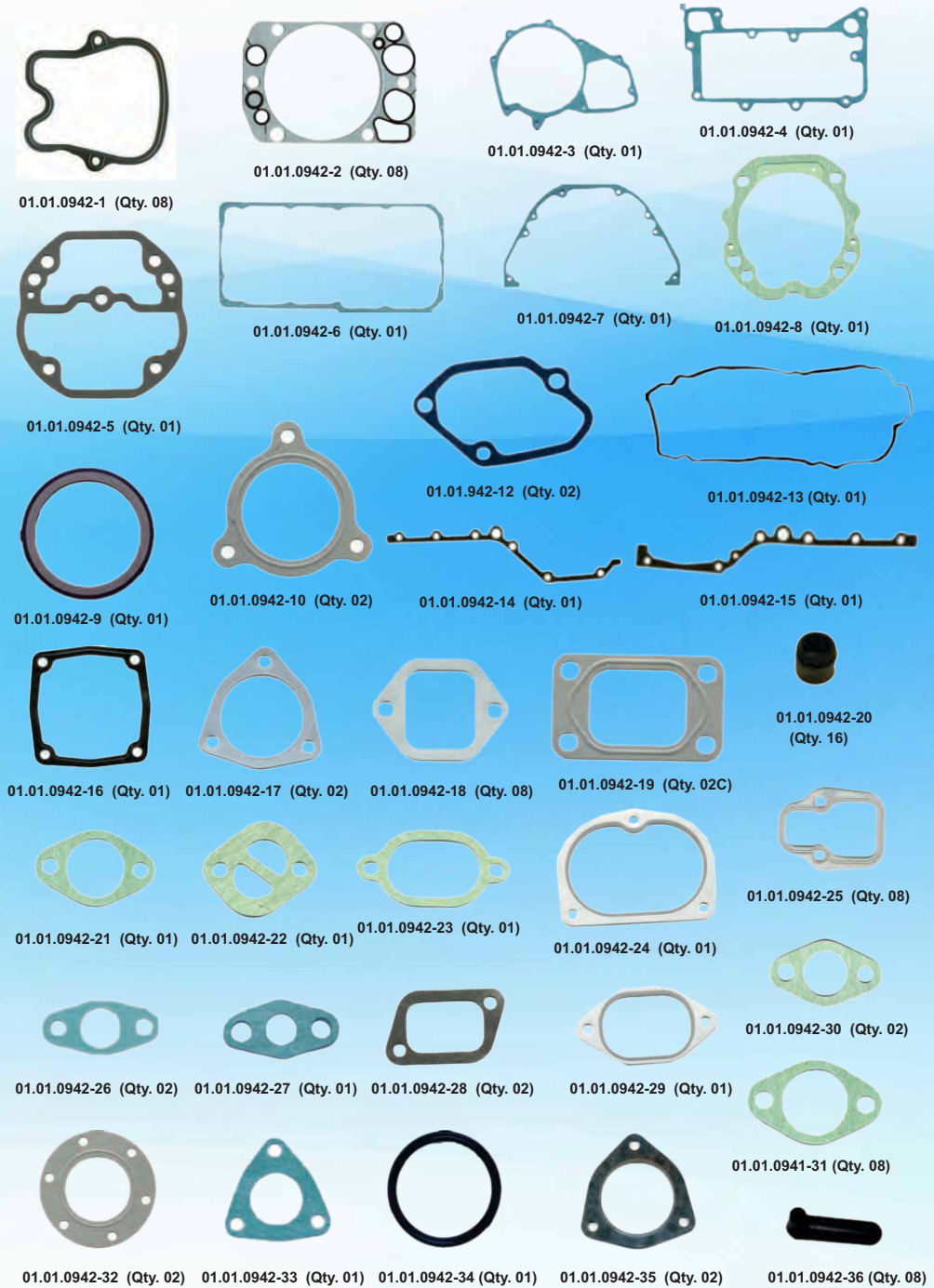

| WASHER & O-RING DETAILS-ORDER BY SIZE   |      |  |
|---|------|--|
| Description                             | Qty. |  |
| G3-3095 NIT.BLACK108 X 98 X 9 MM        | 1    |  |
| G4-3096/1 NIT.BLACK 142X134X4 MM        | 1    |  |
| G4-1441 BNB 81 X 74 X 3 MM              | 2    |  |
| G4-3096/3 NIT.BLACK 69X61X4 MM          | 2    |  |
| G4-3096/4 NIT.BLACK 16X12X2 MM          | 8    |  |
| G4-3096/5 NIT.BLACK 13X7X3 MM           | 1    |  |
| CU WASHER 38 X 44 MM * 1.8              | 1    |  |
| G4-3544/2 CU WASHER 30 X 36.1 X 1.8MM   | 4    |  |
| 26.0 X 31.0 X 1.35 MM CU.               | 6    |  |
| CU WASHER 26.8X22.4 G3-4099/8 * 1.3     | 1    |  |
| CU WASHER 21.8X18.2 G3-4099/10 * 1.3    | 1    |  |
| CU WASHER 9.5 X 20 MM * 1               | 8    |  |
| CU WASHER 14.4X19.8 G3-3580/17 * 1.4    | 6    |  |
| CU WASHER 14.3X17.8 G4-3580/4 * 1.3     | 6    |  |
| G3-3580/2CU WAS 10.1X13.3X0.8 38058WB01 | 1    |  |
| CU WASHER 11.4X8 G3-3512/8 * 0.8        | 3    |  |
| CU WASHER 6.5 X 9.5 MM * 0.9            | 2    |  |

| WASHER & O-RING DETAILS-ORDER BY SIZE           |      |  |
|---|------|--|
| Description                                     | Qty. |  |
| CRCA WASHER 30 X 36 MM * 1.8                    | 4    |  |
| CRCA WASHER 26 X 31 MM * 1.8                    | 3    |  |
| CRCA WASHER 22.2 X 26.8 MM * 1.2                | 9    |  |
| CRCAWASHER14.2X17.8 G3-4099/18 * 1.4            | 6    |  |
| AL WASHER 14.1 X 19.7 MM * 1.3                  | 12   |  |
| G4-3066 POLY. BLK COL.19.5 X 9.5 X 16.00 MM     | 16   |  |
| G4-4559, NITRILE RUB BLACK 95 X103X3.00         | 2    |  |
| G4-3096/2 NIT.BLACK 84X78X3 MM                  | 1    |  |
| G4-4552/2, VITON RUBBER BLACK                   | 4    |  |
| G4-4430/2,SILICON RUB. PANT.1805U(RED)          | 4    |  |
| G4-3534,SEAL                                    | 1    |  |
| G4-3583 AVB 36x42x3 ORING 380597101             | 1    |  |
| G4-4560,VITON RUBBER, BLACK COLOR               | 4    |  |
| G4-4431/2,NITRILE RUB BLACK 35.5 X 28 X 2.00 MM | 1    |  |



MERCEDES

TRUSTTEC NO. 01.01.0944

| OEM NO. | APPLICATION                          | CYLINDER | CAPACITY | YEAR    |
|---------|--------------------------------------|----------|----------|---------|
|         | OM 401 LA,<br>OM 441 A,<br>OM 441 LA | 6        | 9570     | 1987-96 |

OTHER NO.  
914.959

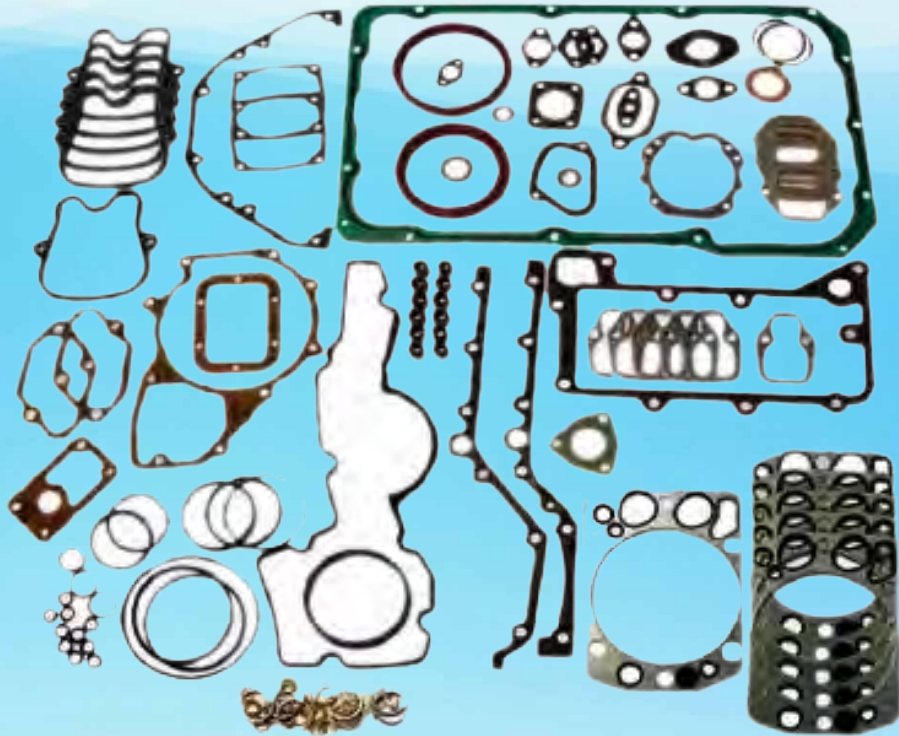

01.01.0944-1 (Qty. 01)



01.01.0944-2 (Qty. 01)



01.01.0944-3 (Qty. 01)



01.01.0944-4 (Qty. 01)



01.01.0944-5 (Qty. 01)



01.01.0944-6 (Qty. 01)



201.01.0944-8 (Qty. 01)

01.01.0944-9 (Qty. 01)

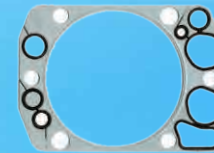

01.01.0944-7 (Qty. 06)

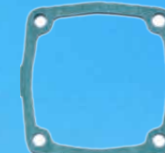

01.01.0944-11 (Qty. 02)



01.01.0944-12 (Qty. 06)



01.01.0944-13 (Qty. 01)



01.01.0944-10 (Qty. 01)



01.01.0944-15 (Qty. 01)

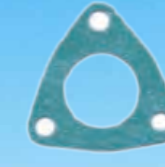

01.01.0944-16 (Qty. 01)



01.01.0944-17 (Qty. 01)



01.01.0944-14 (Qty. 06)



01.01.0944-19 (Qty. 06)



01.01.0944-20 (Qty. 01)

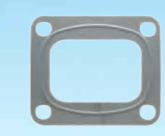

01.01.0944-21 (Qty. 02)



01.01.0944-18 (Qty. 01)



01.01.0944-22 (Qty. 01)



01.01.0944-23 (Qty. 02)



01.01.0944-24 (Qty. 01)

| O-RING DETAILS-ORDER BY SIZE      |      |  |
|-----------------------------------|------|--|
| Description                       | Qty. |  |
| G4-3532 ORING                     | 1    |  |
| G4-3388 ORING BLACK               | 1    |  |
| G4-4431/2 NITBLACK RUB            | 1    |  |
| G4-3096/5 NIT.BLACK 13 X 7 X 3 MM | 1    |  |
| G4-3066 POLY ACRYLIC BLK COL      | 12   |  |
| G3-4569 SILICON RUB GREY          | 2    |  |
| G4-4431/1 NITRILE RUB BLACK COL   | 1    |  |
| G4-2958/2 N RUB BLACK             | 4    |  |
| G4-4552/1 SILICON RUB BRICK       | 2    |  |
| G4-2946/5 NITRILE RUB             | 2    |  |
| G4-4560 VITON RUB BLACK COL       | 2    |  |
| G4-4430/1 VITON RUB BLACK COL     | 2    |  |
| G4-2946/3 NITRILE RUB BLACK COL   | 1    |  |
| G4-3096/2 NIT BLACK               | 1    |  |
| G3-3095 NIT BLACK                 | 1    |  |

| WASHER DETAILS-ORDER BY SIZE |             |      |  |
|------------------------------|-------------|------|--|
| Description                  | Drawing No. | Qty. |  |
| 12.3X16.8X1.50 MM ALU        | NA          | 4    |  |
| 20.2X25.7X1.50 MM ALU        | NA          | 3    |  |
| 26.2X30.8X1.8 MM ALU         | NA          | 1    |  |
| 26X32X2 MM ALU               | NA          | 2    |  |
| G4-4252/310.2X16X0.8         | NA          | 2    |  |
| G3-3512/226.X33.8            | NA          | 1    |  |
| 33.3X 38.9X2.0 CU            | NA          | 1    |  |
| 14.4X19.8X1.4 MM             | G3-3580/17  | 7    |  |
| G3-3512/811.4X8              | G4-3544/2   | 2    |  |
| 30 X 36.1 X 1.8MM CU         | NA          | 5    |  |
| 26.8X22.4X1.3 CU             | G3-4099/18  | 1    |  |
| CU 21.8X18.2X1.3             | G3-4099/10  | 2    |  |
| 9.5 X 20X1 MM CU             | NA          | 6    |  |
| 26.3X30.9X2X2MM              | G4-3544/3   | 4    |  |
| 22.2X26.8X1.2MM              | NA          | 1    |  |
| 14.2X17.8X1.4 MM             | G3-4099/18  | 1    |  |





MERCEDES

TRUSTTEC NO. 01.01.0947

| OEM NO.       | APPLICATION | CYLINDER | CAPACITY | YEAR    |
|---------------|-------------|----------|----------|---------|
| 541 010 05 05 | OM 501 LA   | 6        | 11946    | 1996-02 |

OTHER NO.  
166.340

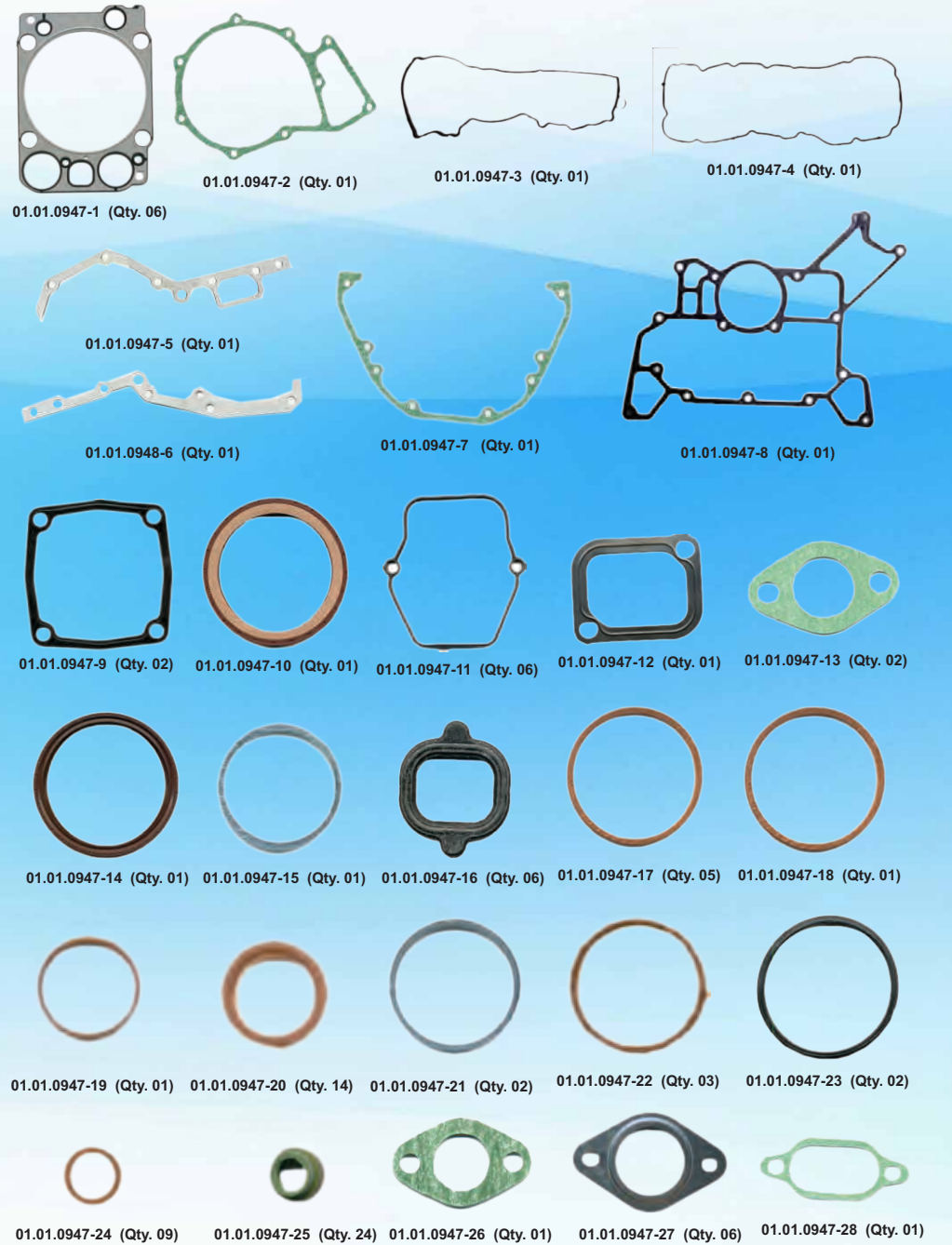
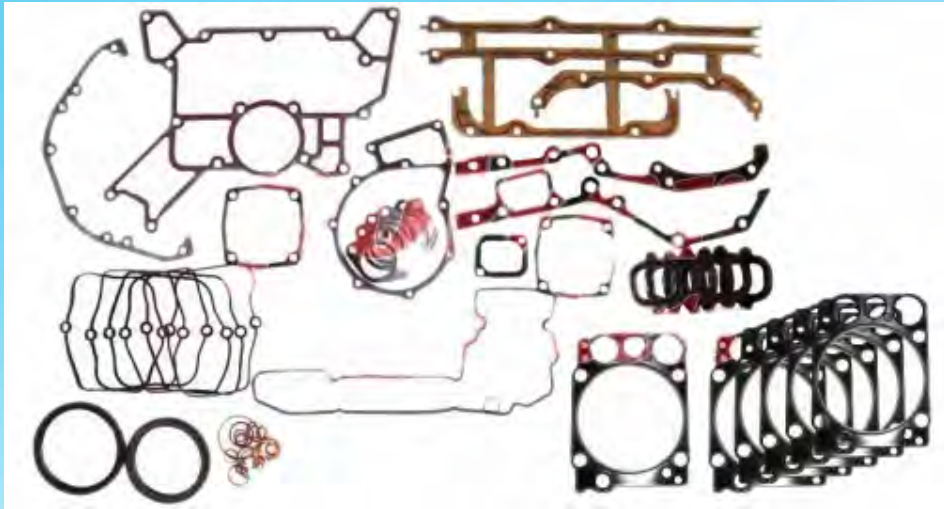

MERCEDES

TRUSTTEC NO. 01.01.0948

| OEM NO.       | APPLICATION | CYLINDER | CAPACITY | YEAR    |
|---------------|-------------|----------|----------|---------|
| 541 010 05 05 | OM 501 LA   | 8        | 15928    | 1996-02 |

OTHER NO.  
166.350

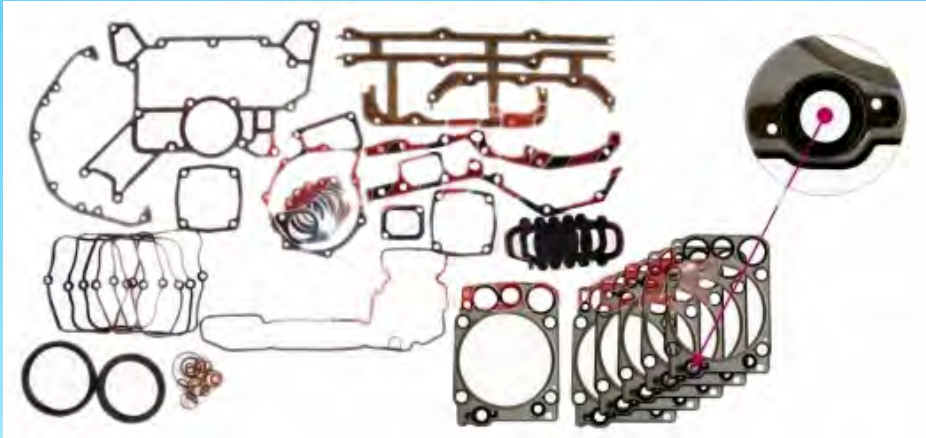

01.01.0948-1 (Qty. 01)



01.01.0948-2 (Qty. 01)

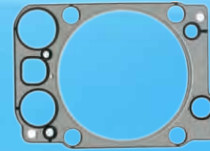

01.01.0948-3 (Qty. 08)



01.01.0948-4 (Qty. 01)



01.01.0948-5 (Qty. 01)



01.01.0948-6 (Qty. 01)



01.01.0948-7 (Qty. 02)



01.01.0948-8 (Qty. 01)

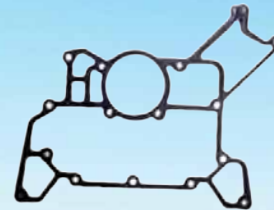

01.01.0948-9 (Qty. 01)

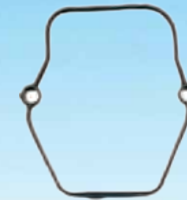

01.01.0948-10 (Qty. 08)



01.01.0949-11 (Qty. 01)

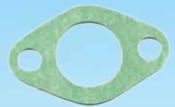

01.01.0949-12 (Qty. 02)

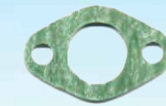

01.01.0948-13 (Qty. 01)



01.01.0948-14 (Qty. 01)

MERCEDES

TRUSTTEC NO. 01.01.0959

| OEM NO.       | APPLICATION | CYLINDER | CAPACITY | YEAR    |
|---------------|-------------|----------|----------|---------|
| 541 010 04 05 | OM 501 LA   | 8        | 15928    | 1996-02 |

OTHER NO.  
166.370

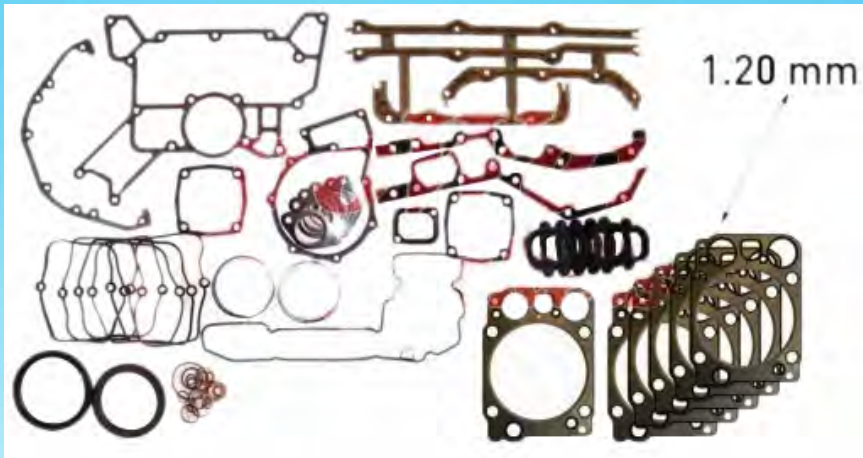

01.01.0959-1 (Qty. 01)



01.01.0959-2 (Qty. 01)

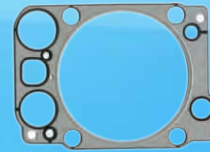

01.01.0959-3 (Qty. 08)



01.01.0959-4 (Qty. 01)



01.01.0959-5 (Qty. 01)



01.01.0959-6 (Qty. 01)



01.01.0959-7 (Qty. 02)



01.01.0959-8 (Qty. 01)

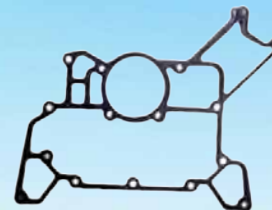

01.01.0959-9 (Qty. 01)

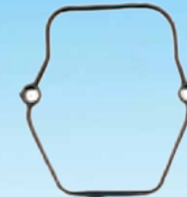

01.01.0959-10 (Qty. 08)



01.01.0959-11 (Qty. 01)

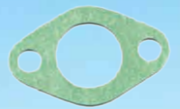

01.01.0959-12 (Qty. 02)

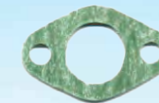

01.01.0959-13 (Qty. 01)



01.01.0959-14 (Qty. 01)

Suitable for

Cylinder Head Gasket

RENAULT

TRUSTTEC NO. 030.01.0901

| OEM NO.   | APPLICATION  | CYLINDER | CAPACITY | YEAR    |
|---|--|----------|----------|---------|
| 50 10 295 726,<br>50 00 670 202,<br>00 00 771 149 | MID 06.20.30,<br>MIDR 06.20.30 / 45,<br>MIDS 06.20.30 / 45 | 6        | 9840     | 1985-98 |

**OTHER NO.**  
61-31115-00, 30-025716-00, 569.320



Head Set Gasket

RENAULT

TRUSTTEC NO. 030.01.0902

| OEMNO.  | APPLICATION  | CYLINDER | CAPACITY | YEAR    |
|---|--|----------|----------|---------|
| 50 00 793 228000 793 626,<br>50 00 793 734, 50 01 826 884 | MID 06.20.30,<br>MIDR 06.20.30 / 45,<br>MIDS 06.20.30 / 45 | 6        | 9840     | 1985-98 |

**OTHER NO.**  
569.500



Suitable for

Cylinder Head Gasket

RENAULT

TRUSTTEC NO. 030.01.0903

| OEM NO.       | APPLICATION  | CYLINDER | CAPACITY | YEAR    |
|---------------|--|----------|----------|---------|
| 74 20 495 935 | Renault Kerax 370.18, 370.26, 410.18<br>410.26, 410.32, 450.18, 450.26, 450.32 | 6        | 10800    | 10/2005 |

| OTHER NO. | APPLICATION  | CYLINDER | CAPACITY | YEAR    |
|-----------|--|----------|----------|---------|
| 225.100   | Renault Premium 2 Distribution 370.18D,<br>370.26, 380.18, 380.19, 410.8D, 410.26,<br>430.18, 430.19, 430.26, 450.18D, 460.19  | 6        | 10800    | 10/2005 |
|           | Renault Premium 2 Lander 380.19,<br>380.26, 430.18, 430.26, 440.18, 440.19,<br>440.32, 460.18, 460.26  | 6        | 10800    | 10/2006 |
|           | Renault Premium 2 Route 330.18 T,<br>380.18, 380.19, 380.26, 410.18, 410.18D,<br>410.24, 410.25, 410.26, 430.19, 430.26,<br>450.18, 450.18D, 450.24, 450.25, 450.26,<br>460.18, 460.26 | 6        | 10800    | 10/2006 |

Renault Dxi 11

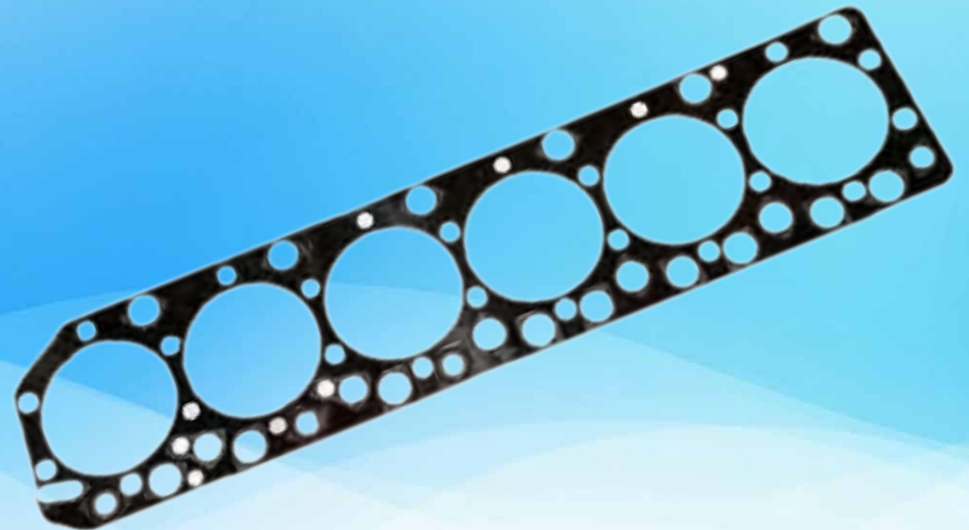

Suitable for

# Cylinder Head Gasket

## RENAULT

TRUSTTEC NO. 030.01.0904

| OEM NO.                                    | APPLICATION  | CYLINDER | CAPACITY | YEAR    |
|--|--|----------|----------|---------|
| 74 20 513 037                              | Renault Kerax 460.32 / 500.32  | 6        | 12800    | 05/2006 |
| <b>OTHER NO.</b><br>61-36855-00<br>548.500 | Renault Magnum Dxi 13 460.18T,<br>460.24, 460.25, 460.26, 460.26T,<br>500.18T, 500.24, 500.25, 500.26, 500.26T | 6        | 12800    | 05/2006 |
|  | Renault Magnum Dxi 520.19, 520.24,<br>520.25, 520.26   | 6        | 12800    | 08/2009 |
|  | Renault Dxi 13 / Dxi   |          |          |         |

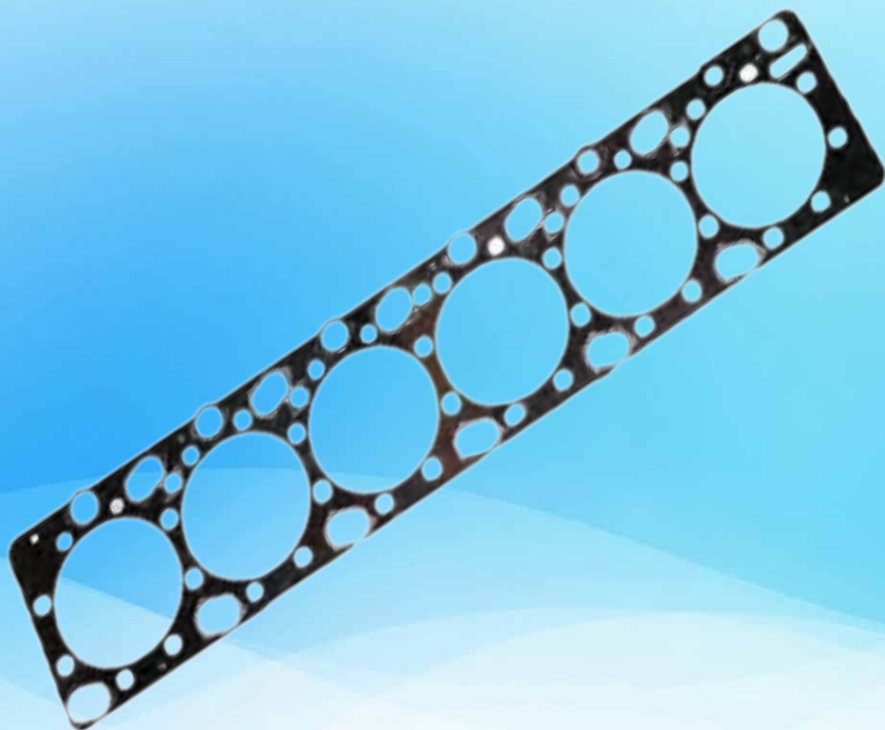

Suitable for

# Cylinder Head Gasket

## SCANIA

TRUSTTEC NO. 030.01.0905

| OEM NO.          | APPLICATION | CYLINDER | CAPACITY | YEAR    |
|------------------|-------------|----------|----------|---------|
| 170274-5         | D 14,       | 8        | 1420     | 1969 ON |
| <b>OTHER NO.</b> |             |          |          |         |



TRUSTTEC NO. 030.01.0906

| OEM NO.                                     | APPLICATION | CYLINDER | CAPACITY | YEAR      |
|---|-------------|----------|----------|-----------|
| 177 014<br>161 870                          | D 11,       | 6        | 1100     | 1963-1974 |
| <b>OTHER NO.</b><br>60-24805-10,<br>000.442 |             |          |          |           |

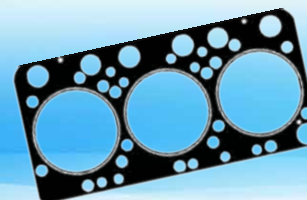

TRUSTTEC NO. 030.01.0907

| OEM NO.                                     | APPLICATION   | CYLINDER | CAPACITY | YEAR    |
|---|---------------|----------|----------|---------|
| 373 472                                     | DN 11, DS 11, | 6        | 8475     | 1980 ON |
| <b>OTHER NO.</b><br>61-31220-00,<br>893.463 |               |          |          |         |

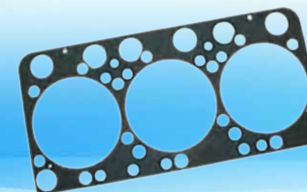

TRUSTTEC NO. 030.01.0908

| OEM NO.                                     | APPLICATION     | CYLINDER | CAPACITY | YEAR    |
|---|-----------------|----------|----------|---------|
| 1 313 459,<br>1 403, 587                    | Ds 14<br>DSC 14 | 8        | 11020    | 1980 ON |
| <b>OTHER NO.</b><br>61-31050-00,<br>893.472 |                 |          |          |         |



# Suitable for Cylinder Head Gasket

## SCANIA

TRUSTTEC NO. 06.01.0401

**OEM NO.**

1 403 258,  
291 159  
346 216  
387 503

**OTHER NO.**

61-31160-00,  
893-463

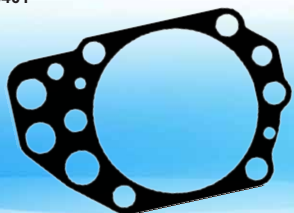

| APPLICATION  | CYLINDER | CAPACITY | YEAR    |
|--------------|----------|----------|---------|
| DS 9, DSC 9, | 6        | 8475     | 1980 ON |

TRUSTTEC NO. 06.01.0402

**OEM NO.**

257 381

**OTHER NO.**

61-25380-10,  
347.523

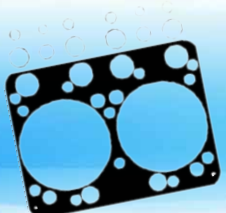

| APPLICATION      | CYLINDER | CAPACITY | YEAR    |
|------------------|----------|----------|---------|
| D 8, DS 8, DSI 8 | 6        | 7800     | 1980 ON |

TRUSTTEC NO. 06.01.0403

**OEM NO.**

1 377 039  
1 403 260  
1 444 941

**OTHER NO.**

61-34880-00,  
125.780



| APPLICATION    | CYLINDER | CAPACITY | YEAR    |
|----------------|----------|----------|---------|
| DSC 12, DC 12, | 6        | 10600    | 1980 ON |

TRUSTTEC NO. 06.01.0404

**OEM NO.**

1 403 603,  
1 468 555

**OTHER NO.**

61-34885-00,  
125.830



| APPLICATION | CYLINDER | CAPACITY | YEAR    |
|-------------|----------|----------|---------|
| DS 16       | 6        | 11700    | 2000 ON |

# Suitable for Head Gasket Set

## SCANIA

TRUSTTEC NO. 06.01.0405

**OEM NO.**

550099-6

| APPLICATION | CYLINDER | CAPACITY | YEAR    |
|-------------|----------|----------|---------|
| D 14,       | 8        | 14200    | 1969 ON |



TRUSTTEC NO. 06.01.0406

**OEMNO.**

551 500,  
551 512

| APPLICATION  | CYLINDER | CAPACITY | YEAR    |
|--------------|----------|----------|---------|
| DN 11, DS 11 | 6        | 11020    | 1980 ON |

**OTHER NO.**

02-31220-02,  
921.807

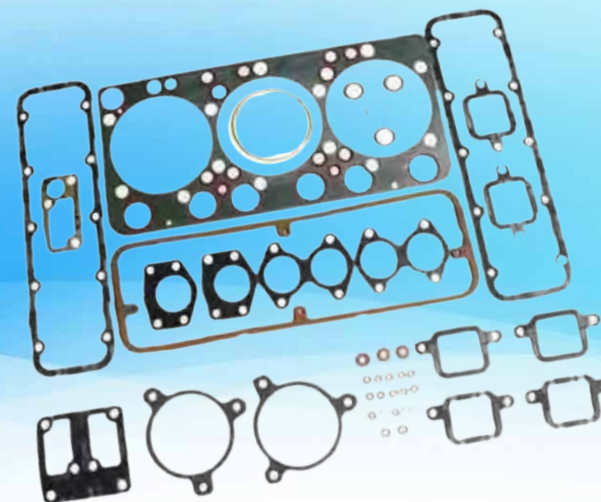

Suitable for

Head Gasket Set

SCANIA

TRUSTTEC NO. 06.01.0407

| OEM NO.          | APPLICATION            | CYLINDER | CAPACITY | YEAR    |
|------------------|------------------------|----------|----------|---------|
| 550 214, 551 469 | D 14, DS 14,<br>DSC 14 | 8        | 14200    | 1980 ON |

OTHER NO.

03-31050-01,  
586.627



TRUSTTEC NO. 06.01.0408

| OEM NO. | APPLICATION | CYLINDER | CAPACITY | YEAR    |
|---------|-------------|----------|----------|---------|
| 551 484 | DS 9, DSC 9 | 6        | 8475     | 1989 ON |

OTHER NO.

03-31160-01  
922.129  
21-26849-21/0



Suitable for

Head Gasket Set

SCANIA

TRUSTTEC NO. 06.01.0409

| OEM NO. | APPLICATION    | CYLINDER | CAPACITY | YEAR    |
|---------|----------------|----------|----------|---------|
| 551 363 | DSC 12, DC 12, | 6        | 10600    | 1996 ON |

OTHER NO.

03-34880-01,  
138.501

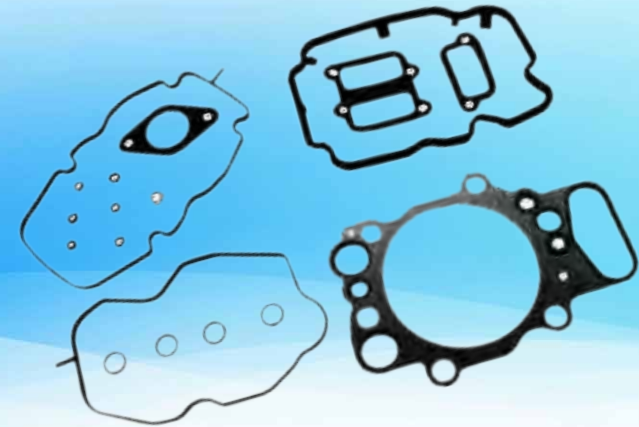

TRUSTTEC NO. 06.01.0410

| OEM NO. | APPLICATION | CYLINDER | CAPACITY | YEAR    |
|---------|-------------|----------|----------|---------|
| 550 469 | DC 16       | 6        | 11700    | 2000 ON |

OTHER NO.

03-34885-01  
138.491



TRUSTTEC NO. 06.01.0411

| OEM NO. | APPLICATION   | CYLINDER | CAPACITY | YEAR      |
|---------|---------------|----------|----------|-----------|
| 551 470 | DS 14, DSC 14 | 8        | 14190    | 1988 - 96 |

OTHER NO.  
597.717

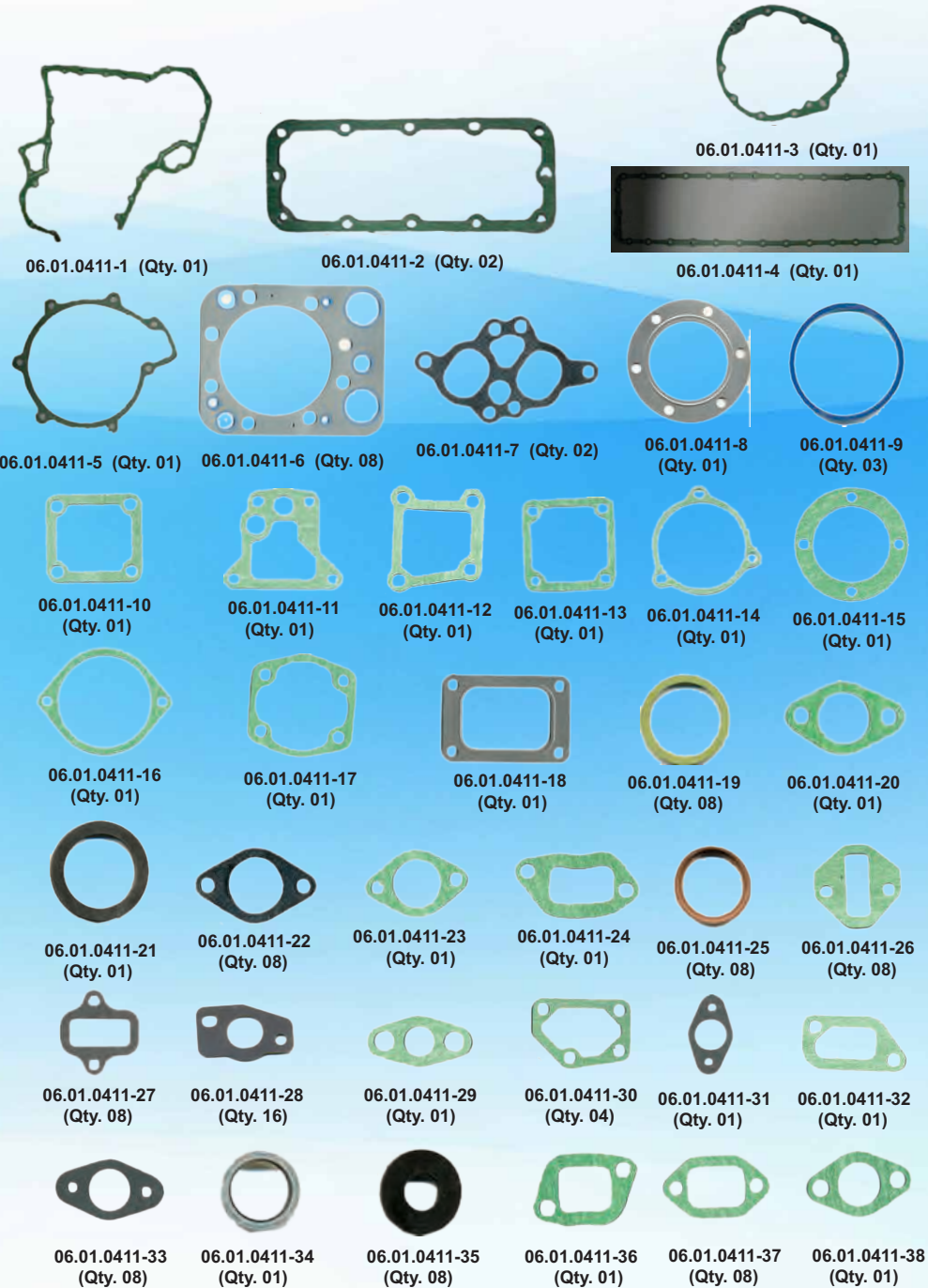

| O-RING DETAILS-ORDER BY SIZE |           |      |
|------------------------------|-----------|------|
| Description                  |           | Qty. |
| SILCON RUB.(YELLOW)          | G4-4712   | 1    |
| SILCON RUB.(BLUE)            | G4-4420   | 1    |
| SILCON RUB.(YELLOW)          | G4-3505   | 1    |
| NITRILE RUB.(GREEN)          | G4-1217/5 | 4    |
| VITON RUB.(BLACK)            | G4-3515   | 2    |
| VITON RUB.(BROWN)            | G4-3515   | 1    |
| SILCON(BLACK)                | G4-3494   | 1    |
| NITRILE RUB.(BLACK)          | G5-2496/1 | 1    |
| NITRILE RUB.(BLACK)          | G4-3493   | 1    |
| NITRILE RUB.(BLACK)          | G4-3499/1 | 1    |
| VITON RUB.(LIGHT GREEN)      | G4-3507   | 1    |
| SILCON RUB.(BLACK)           | G4-3459   | 1    |
| SILCON RUB.(BLACK)           | G4-3511   | 1    |
| SILCON RUB.(BLACK)           | G4-3509   | 1    |
| VITON RUB.(LIGHT GREN)       | G4-3502   | 1    |
| VITON RUB.(LIGHT GREN)       | G4-4711   | 1    |
| VITON RUB.(LIGHT GREN)       | G4-4711   | 16   |

| Description          |            | Qty. |
|----------------------|------------|------|
| 2.3X25.9X1.30 MMCU   | G3-4099/9  | 2    |
| 23.7X18.5X1.0 ALU    |            | 1    |
| 21.7X18.3X1.40 MMCU  | G4-3544/4  | 2    |
| 20X16X1.30 MMCU      | G4-3580/18 | 2    |
| 15.8X12.3X1.50 MMALU |            | 4    |
| 14.8X10.3X1.0XMM ALU |            | 5    |
| 10.1X0.80 MM CU      | G4-3580/25 | 8    |
| SPRIG STEEL          | G4-4426    | 1    |

| WASHER DETAILS-ORDER BY SIZE |            |      |
|------------------------------|------------|------|
| Description                  |            | Qty. |
| SPRING STEEL                 | G4-3546    | 16   |
| 41.8X36.2X1.80 MM ALU        | G3-3512/1  | 1    |
| 33.8X26.2X2 MM CU            | G3-3512/2  | 4    |
| 31X26.5X2 MM CU              | G3-3512/4  | 1    |
| 11.3X8.2X0.80 MM CU          | G3-3512/8  | 25   |
| 168X14.3X1.30 MM ALU         | G3-3512/10 | 3    |
| 37.8X24.3X0.80XMM ALU        | G4-3512/11 | 1    |
| 20X9.4X1.80 MM CU            | G3-3512/16 | 8    |
| 21.7X16.3X0.80 MMCU          | G3-3512/17 | 2    |
| 19.7X14.3X1.35 MMCU          | G3-3580/17 | 30   |
| 22.7X20X1.0 MMCU             |            | 3    |
| 50X44.5 MM                   | G43514/1   | 1    |
| 25.8X22.3X1.35 MMALU         |            | 4    |

SCANIA

TRUSTTEC NO. 06.01.0412

| OEM NO.   | APPLICATION              | CYLINDER | CAPACITY | YEAR    |
|-----------|--------------------------|----------|----------|---------|
| 551 519   | DS 11, DSC 11,<br>DTC 11 | 6        | 11020    | 1980 ON |
| OTHER NO. |                          |          |          |         |
| 922.332   |                          |          |          |         |

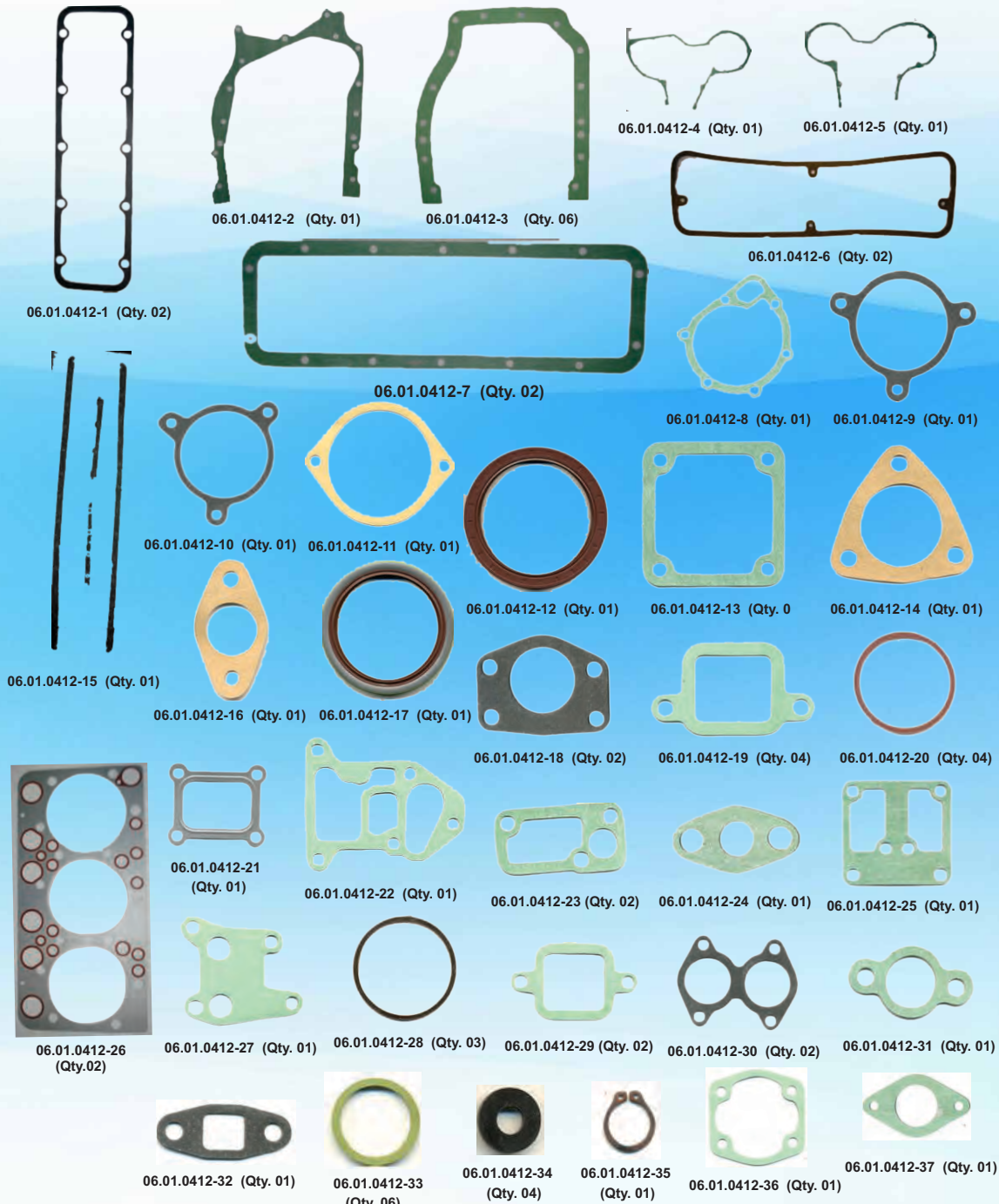
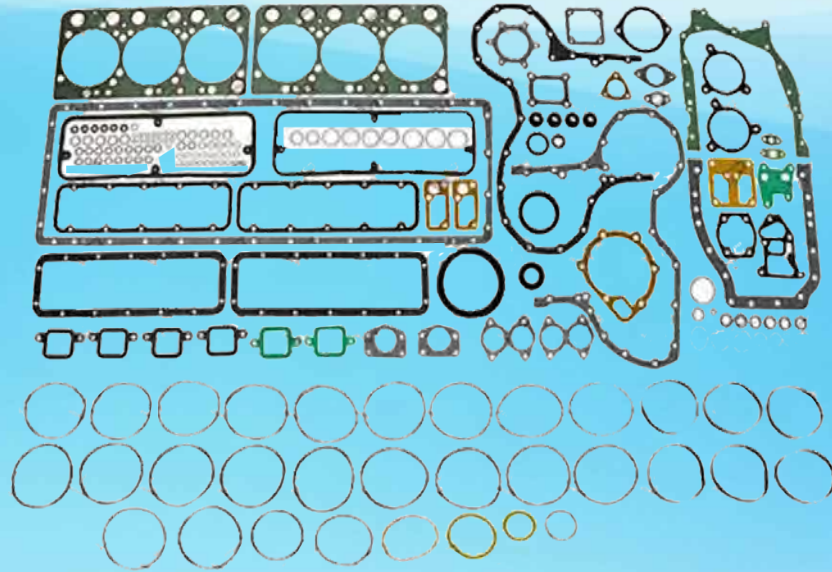

| WASHER DETAILS-ORDER BY SIZE        |      |  |
|-------------------------------------|------|--|
| Description                         | Qty. |  |
| G3-3512/10,AL-WASHER                | 5    |  |
| 14.2X19.8 CUWASHER G3-3512/18 ' 1.4 | 15   |  |
| 16.5 X 20 CU WASHER SCANIA ' 1.3    | 1    |  |
| G3-3512/11,AL-WASHER,               | 1    |  |
| 20.30 X 25.80 X 1.0 MM ALUMINIUM    | 1    |  |
| G3-3512/21,AL-WASHER                | 4    |  |
| 14.3X17.8CUWASCANIAG3-3512/23 ' 1.3 | 1    |  |
| CU WASHER- 20X9.5 G3-3512/16 ' 1.8  | 6    |  |
| CU WASHER 25.9X20.3 G3-4099/9 ' 1.3 | 4    |  |
| AL WASHER 18.5 X 22.9 X 1.0 MM      | 3    |  |
| 15.30 X 18.70 X 1.0 MM ALUMINIUM    | 1    |  |
| AL WASHER 10.1 X 14.9 X 1.0 MM      | 15   |  |
| CU WASHER 11.4X8 G3-3512/8 ' 0.8    | 15   |  |

| O-RING DETAILS-ORDER BY SIZE           |      |  |
|--|------|--|
| Description                            | Qty. |  |
| G4-3516 VITON RUB. LIGHT GRN           | 6    |  |
| G4-3555 SEAL ANB 380586801 40.5X56.5X3 | 1    |  |
| G4-3504,O-RING 65X3 ANB 540167701      | 1    |  |
| G4-3503,O-RING,VITON RUB               | 3    |  |
| G4-3502,O-RING,VITON RUB               | 1    |  |
| G4-3501 VITON RUB LIGHT GREEN          | 2    |  |
| G4-3500,O-RING NIT.RUB.                | 1    |  |
| G4-3493,O-RING,NIT.RUB.540166201       | 1    |  |
| G4-3494,O-RING,SILICON RUB             | 1    |  |
| G4-3495,O-RING,SILICON RUB             | 1    |  |
| G4-3496 SIL RUB LEM YELLOW 'O' RING    | 1    |  |
| G4-3497,O-RING,SILICON RUB.            | 1    |  |
| G4-3459 SILI RUBBER BLACK              | 1    |  |
| G4-3499/1,O-RING,NIT.RUB.              | 1    |  |
| G4-3498,O-RING,NITRILE RUB             | 1    |  |
| G4-4548VITON RUB GREEN                 | 18   |  |
| G4-4549VITON RUB BLACK                 | 6    |  |
| G4-4705SILICON RUB                     | 1    |  |
| G4-4556VITON RUB GREEN                 | 1    |  |



SCANIA

TRUSTTEC NO. 06.01.0414

OEM NO. 551 459 APPLICATION DS9, DSC9 CYLINDER 6 CAPACITY 8475 YEAR 1984 ON

OTHER NO. 01-31160-02, 922.323

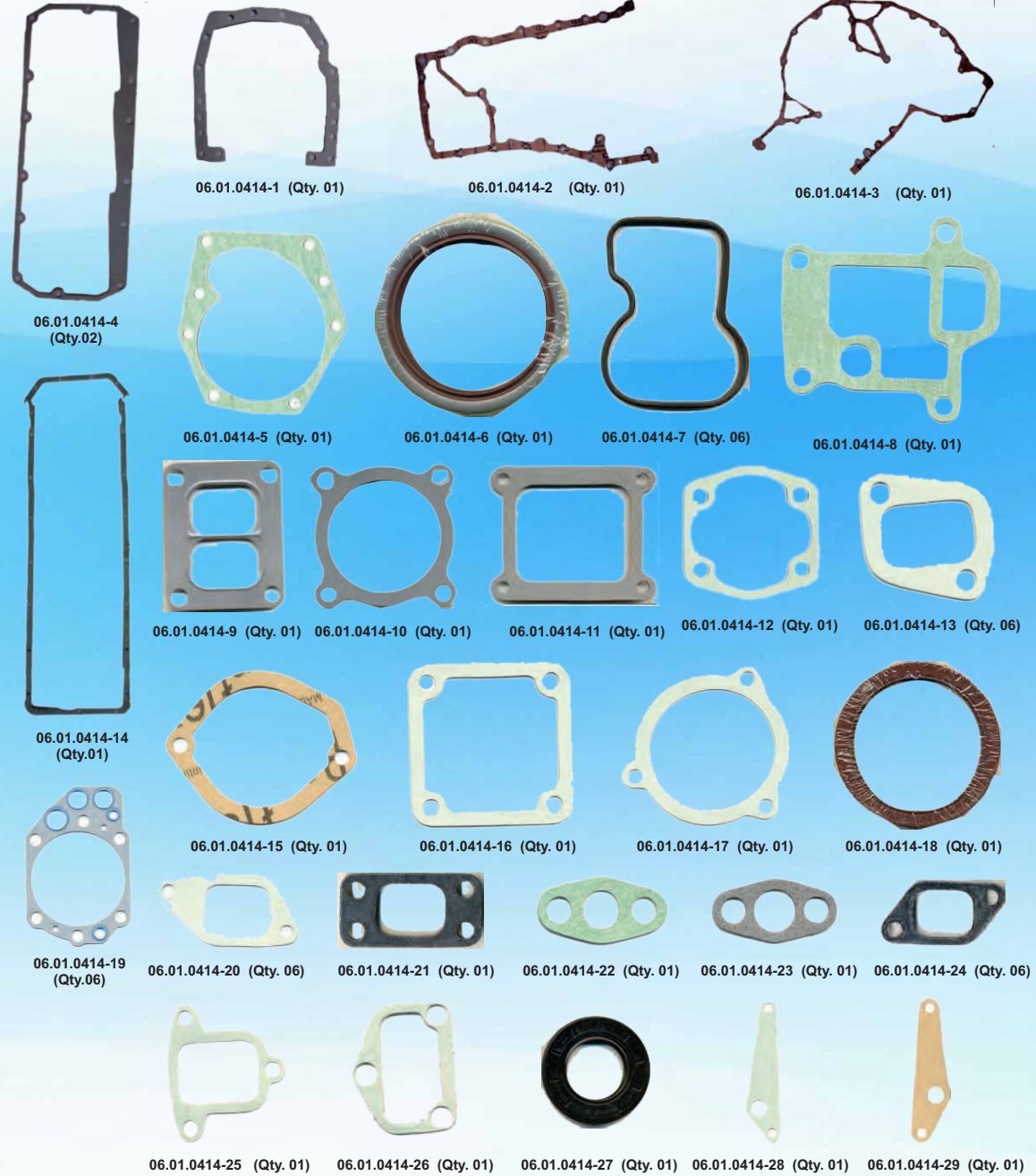
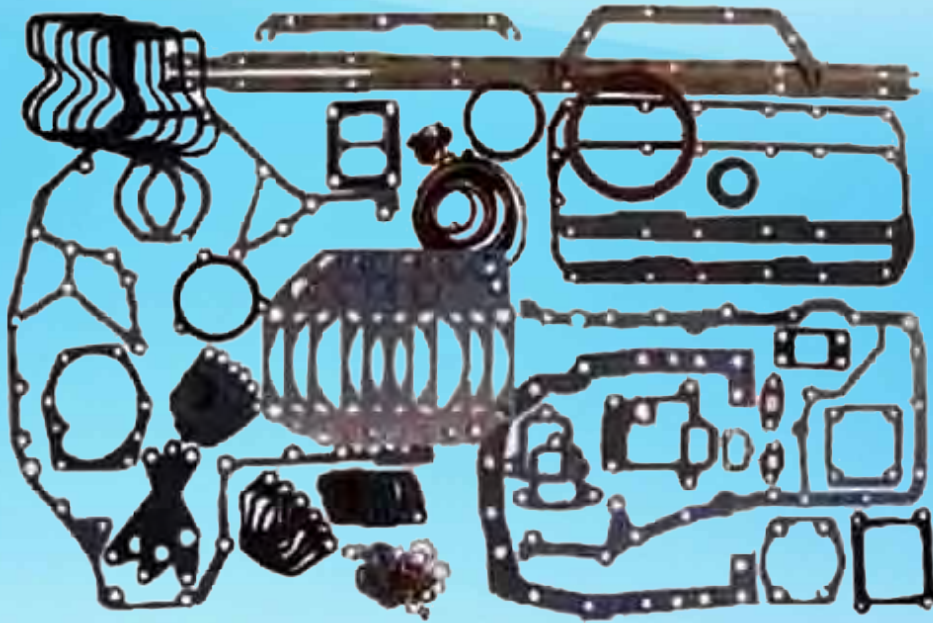

| WASHER & O-RING DETAILS-ORDER BY SIZE |      |
|---------------------------------------|------|
| Description                           | Qty. |
| G4-3494, O-RING, SILICON RUB          | 1    |
| G4-3459 SILI RUBBER BLACK             | 1    |
| O RING G4-3711 ' 3                    | 2    |
| O RING G4-3706 ' 3                    | 2    |
| O RING G4-3713 ' 3                    | 1    |
| O RING G4-3710 ' 3                    | 1    |
| G4-3712 RUBBER GASKET                 | 1    |
| G4-3504, O-RING 65X3 ANB 540167701    | 2    |
| AL WASHER G4-3743/4 ' 0.8             | 1    |
| G4-3520 CRCA+NITRILE RUB WASHER       | 1    |
| G4-3498, O-RING, NITRILE RUB          | 1    |
| G4-3500, O-RING, NIT. RUB.            | 1    |
| G4-3725 O RING                        | 6    |
| CU WASHER 10.3X13.3 ' 0.8             | 5    |
| CU WASHER G4-3743/2 ' 0.8             | 1    |
| G4-3493, O-RING, NIT. RUB. 540166201  | 1    |
| G4-3718 O RING                        | 2    |
| G4-3510 SIL RUB BLACK                 | 2    |

| WASHER & O-RING DETAILS-ORDER BY SIZE    |      |
|--|------|
| Description                              | Qty. |
| G4-3492, O-RING, VITON RUBBER            | 1    |
| G4-3499/1, O-RING, NIT. RUB.             | 6    |
| AL WASHER G4-3743/5 ' 1.85               | 1    |
| CU WASHER G4-3512/4 ' 1.95               | 1    |
| G3-3580/13AL WAS 22.2X26.8X1.3 38058WM01 | 1    |
| G3-3512/22, AL-WASHER                    | 2    |
| AL WASHER 18.2X21.9X1.30(G4-3743/5)      | 1    |
| G3-3512/10, AL-WASHER                    | 5    |
| 14.3X17.8CUWASCANIAG3-3512/23 ' 1.3      | 4    |
| G3-3512/21, AL-WASHER                    | 2    |
| AL WASHER10.3X13.8(G3-3512/15 ' 1.3      | 3    |
| CU WASHER- 20X9.5 G3-3512/16 ' 1.8       | 6    |
| 14.2X19.8 CUWASHER G3-3512/18 ' 1.4      | 11   |
| G3-3580/1CU WAS. 8X11.3X0.8 38058WA01    | 14   |
| G4-3709 ' 5.7                            | 1    |
| G4-3708 ' 6                              | 1    |
| G4-3744 SEAL                             | 1    |

# Suitable for

# Cylinder Head Gasket

## VOLVO

TRUSTTEC NO. 016.01.0350

**OEM NO.**

275 740 - 9

**OTHER NO.**

60-25025-20,  
518.301

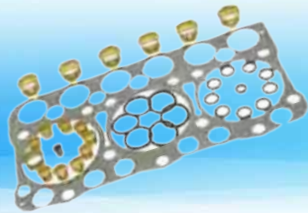

**APPLICATION**      **CYLINDER**      **CAPACITY**

D 50, D 60, TD 50,      6      5480  
TD 60

TRUSTTEC NO. 016.01.0351

**OEM NO.**

276 821-6

**OTHER NO.**

60-31090-10,  
754.641

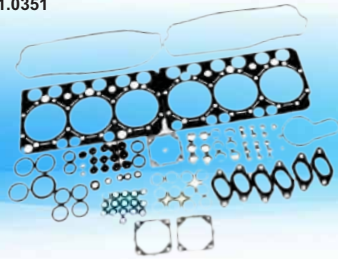

**APPLICATION**      **CYLINDER**      **CAPACITY**      **YEAR**

TD 61, TD 63      6      5480      1986 ON

TRUSTTEC NO. 016.01.0352

**OEM NO.**

275 525 - 4

**OTHER NO.**

60-23155-10,  
108.197

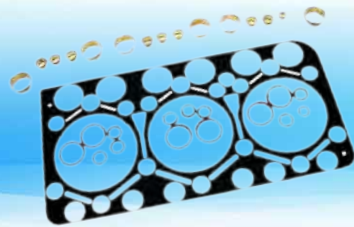

**APPLICATION**      **CYLINDER**      **CAPACITY**      **YEAR**

D 70, TD 70,      6      6700      1966-1978

TRUSTTEC NO. 016.01.0353

**OEM NO.**

275 779 - 7

**OTHER NO.**

60-31095-10,  
087.289

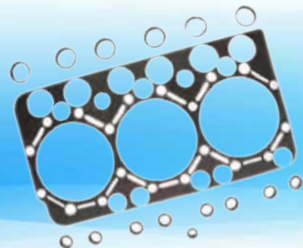

**APPLICATION**      **CYLINDER**      **CAPACITY**      **YEAR**

TD 71, TD 73      6      6730      1985 ON

# Suitable for

# Cylinder Head Gasket

## VOLVO

TRUSTTEC NO. 016.01.0354

**OEM NO.**

275 551 - 0

**OTHER NO.**

60-23160-10,  
087.289

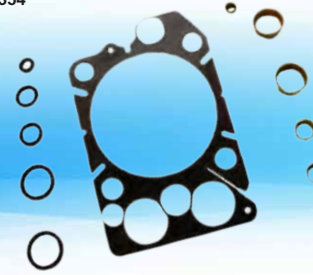

**APPLICATION**      **CYLINDER**      **CAPACITY**      **YEAR**

D 100, TD 100,      6      9600      1966-1980  
HD 100, THD 100

TRUSTTEC NO. 016.01.0355

**OEM NO.**

270 789 - 1

**OTHER NO.**

60-27190-10,  
755.206



**APPLICATION**      **CYLINDER**      **CAPACITY**      **YEAR**

TD 100, TD 101,      6      9600      1982-1985  
TD 102, TD 103,  
THD 100, THD 101,  
THD 102, THD 103

TRUSTTEC NO. 016.01.0356

**OEM NO.**

275 742 - 5

**OTHER NO.**

517.046

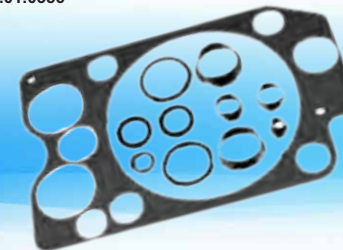

**APPLICATION**      **CYLINDER**      **CAPACITY**      **YEAR**

D 100, TD 100,      6      9600      1981 ON  
HD 100, THD 100

TRUSTTEC NO. 016.01.0357

**OEM NO.**

270 772 -7  
270 949 -1  
275 557 -4

**OTHER NO.**

470.837

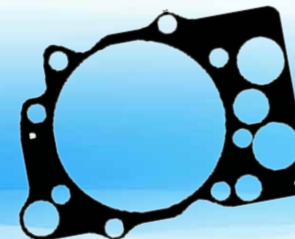

**APPLICATION**      **CYLINDER**      **CAPACITY**      **YEAR**

F 12, N 12,      6      1996 ON  
TD 120

# Suitable for VOLVO Cylinder Head Gasket

TRUSTTEC NO. 016.01.0358

**OEM NO.**

275 548 - 6

**OTHER NO.**

60-23215-10,  
087.335



| APPLICATION     | CYLINDER | CAPACITY | YEAR    |
|-----------------|----------|----------|---------|
| TD 120, TD 121, | 6        | 11980    | 1970 ON |

TRUSTTEC NO. 016.01.0359

**OEM NO.**

270 949 - 1

**OTHER NO.**

60-31085-10,  
755.621

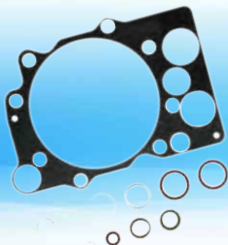

| APPLICATION    | CYLINDER | CAPACITY | YEAR    |
|----------------|----------|----------|---------|
| TD 122, TD 123 | 6        | 11980    | 1987 ON |

TRUSTTEC NO. 016.01.0360

**OEM NO.**

20 412 953, 20 415 954,  
276 887, 276 916,  
3 093 503, 3 099 100

**OTHER NO.**

115.151

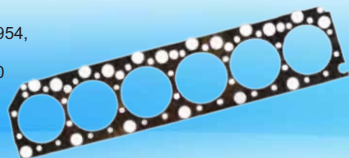

| APPLICATION | CYLINDER | CAPACITY | YEAR    |
|-------------|----------|----------|---------|
| D 12A/C/D   | 6        | 12100    | 1993 ON |
| VOLVO FH 12 |          |          |         |

# Suitable for VOLVO Cylinder Head Gasket

TRUSTTEC NO. 016.01.0361

**OEM NO.**

20 495 934, 20 495 935,  
8 148 046

**OTHER NO.**

225.100

**APPLICATION**

Volvo 7700 Bus  
Volvo FM 9/260,300, 340, 380  
Volvo FM 300, 340, 380  
Volvo D 11 - 325, 355, 365, 385, 405  
Volvo D9A 260, 300, 340, 380  
Volvo D9B 260, 300, 310, 340, 360, 380

**CYLINDER CAPACITY YEAR**

6 06/2006  
6 12.01-09.05  
6 09/2005  
6 10800  
6 9364  
6 9364

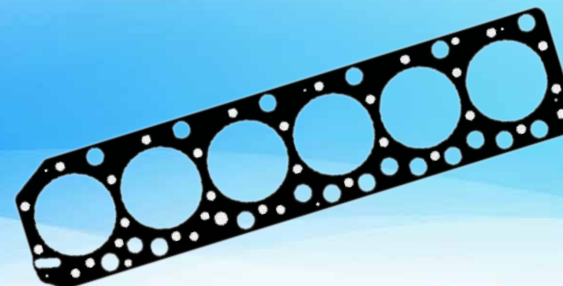

TRUSTTEC NO. 016.01.0362

**OEMNO.**

20513037  
21313537  
21510072  
7420513037

**OTHER NO.**

61-36855-00  
548.500

**APPLICATION**

Volvo FH 400, 440, 480  
Volvo FM 500, FH 520  
Volvo FM 360, 400, 440, 480, 500  
Volvo D 13 A - 360, 400, 440, 480, 520  
Volvo D 13 B - 360, 400, 440, 500

**CYLINDER CAPACITY YEAR**

6 09/2005  
6 09/2007  
6 11/2005  
6 12800  
6 12800

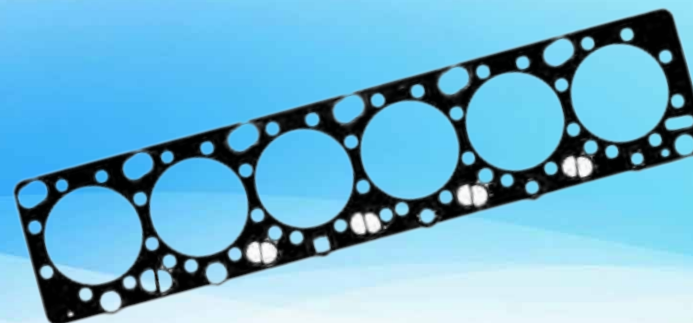

Suitable for

Head Gasket Set

**VOLVO**

TRUSTTEC NO. 016.01.0363

| OEM NO.     | APPLICATION                 | CYLINDER | CAPACITY | YEAR      |
|-------------|-----------------------------|----------|----------|-----------|
| 275 740 - 9 | D 50, D 60,<br>TD 50, TD 60 | 6        | 5480     | 1980-1985 |

**OTHER NO.**  
02-25025-04,  
563.413

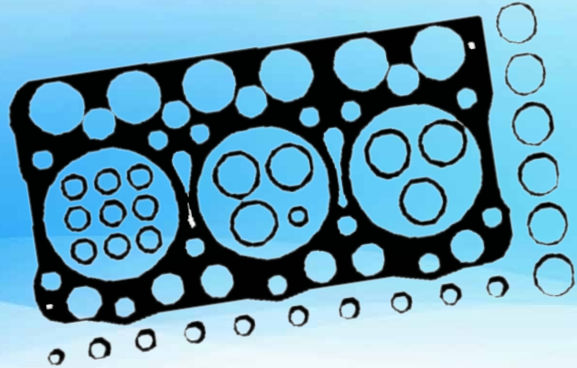

TRUSTTEC NO. 016.01.0364

| OEM NO.     | APPLICATION                       | CYLINDER | CAPACITY | YEAR      |
|-------------|-----------------------------------|----------|----------|-----------|
| 275 551 - 0 | D 100, TD 100,<br>HD 100, THD 100 | 6        | 9600     | 1966-1980 |

**OTHER NO.**  
02-23160-03,  
109.828



Suitable for

Head Gasket Set

**VOLVO**

TRUSTTEC NO. 016.01.0365

| OEM NO.  | APPLICATION   | CYLINDER | CAPACITY | YEAR      |
|----------|---|----------|----------|-----------|
| 270789-1 | TD 100, TD 101,<br>TD 102, TD 103,<br>THD 100, THD 101,<br>THD 102, THD 103 | 6        | 9600     | 1982-1987 |

**OTHER NO.**  
02-27190-02,  
571.220

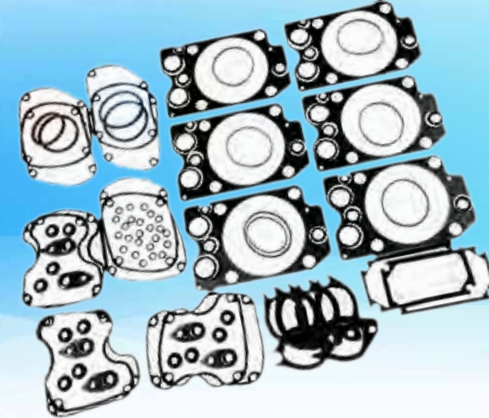

TRUSTTEC NO. 016.01.0366

| OEM NO.     | APPLICATION    | CYLINDER | CAPACITY | YEAR    |
|-------------|----------------|----------|----------|---------|
| 275 548 - 6 | TD 120, TD 121 | 6        | 11980    | 1970 ON |

**OTHER NO.**  
02-23215-02,  
109.844

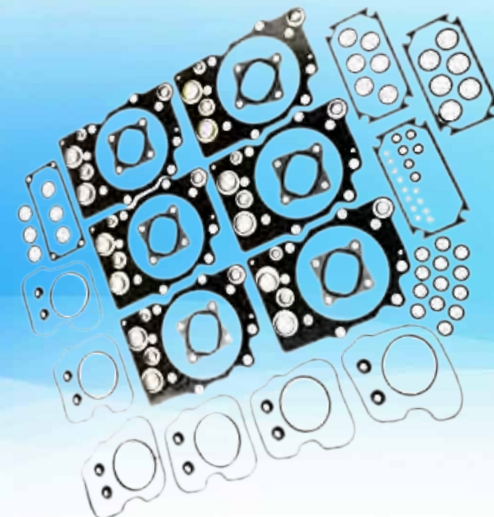

Suitable for

Head Gasket Set

**VOLVO**

TRUSTTEC NO. 016.01.0367

| OEM NO.     | APPLICATION   | CYLINDER | CAPACITY | YEAR    |
|-------------|---------------|----------|----------|---------|
| 275 779 - 7 | TD 71, TD 73, | 6        | 6730     | 1985 ON |

OTHER NO.

02-31095-01  
920.738

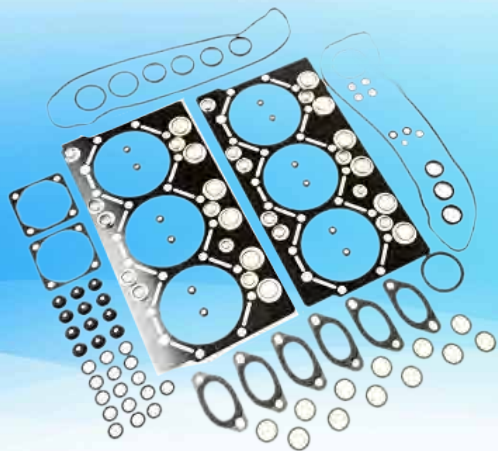

TRUSTTEC NO. 016.01.0368

| OEM NO.     | APPLICATION  | CYLINDER | CAPACITY | YEAR    |
|-------------|--------------|----------|----------|---------|
| 275 774 - 8 | TD 61, TD 63 | 6        | 5480     | 1986 ON |

OTHER NO.

02-31090-01,  
916.021

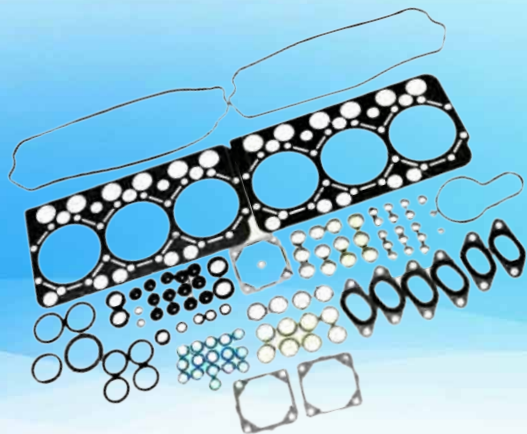

Suitable for

Head Gasket Set

**VOLVO**

TRUSTTEC NO. 016.01.0369

| OEM NO. | APPLICATION     | CYLINDER | CAPACITY | YEAR    |
|---------|-----------------|----------|----------|---------|
|         | TD 122, TD 123, | 6        | 11980    | 1987 ON |

OTHER NO.

02-31085-01  
917.109

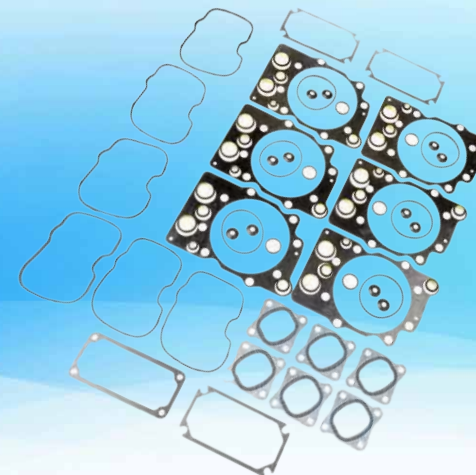

TRUSTTEC NO. 016.01.0370

| OEMNO.      | APPLICATION | CYLINDER | CAPACITY | YEAR      |
|-------------|-------------|----------|----------|-----------|
| 275 525 - 4 | D 70, TD 70 | 6        | 6700     | 1966-1978 |

OTHER NO.

02-23155-02,  
563.499

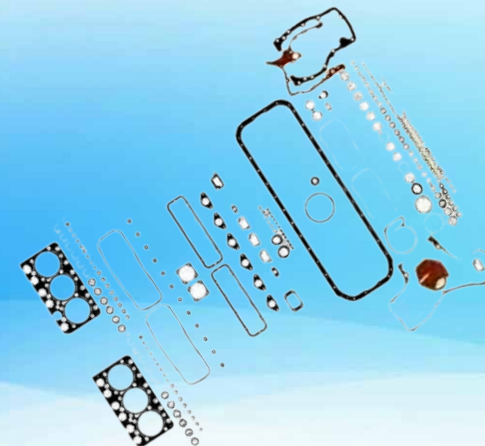

Suitable for

Head Gasket Set

**VOLVO**

TRUSTTEC NO. 016.01.0371

| OEM NO.     | APPLICATION     | CYLINDER | CAPACITY | YEAR    |
|-------------|-----------------|----------|----------|---------|
| 276 124 - 5 | TD 120, TD 121, | 6        | 11980    | 1970 ON |

OTHER NO.

08-24875-03,  
108.325



Suitable for

Head Gasket Set

**VOLVO**

TRUSTTEC NO. 016.01.0373

| OEM NO.     | APPLICATION               | CYLINDER | CAPACITY | YEAR    |
|-------------|---------------------------|----------|----------|---------|
| 276 123 - 7 | TD 101, TD 102,<br>TD 103 | 6        | 9600     | 1995-98 |

OTHER NO.

08-24860-05,  
755.338



TRUSTTEC NO. 016.01.0372

| OEM NO.     | APPLICATION                     | CYLINDER | CAPACITY | YEAR    |
|-------------|---------------------------------|----------|----------|---------|
| 276 122 - 9 | D 100, TD 100<br>TD 101, TD 102 | 6        | 9600     | 1966-80 |

OTHER NO.

08-24860-04,  
108.295

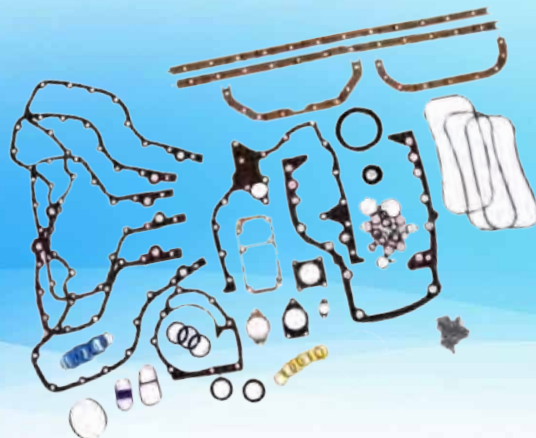

TRUSTTEC NO. 016.01.0374

| OEM NO.                    | APPLICATION    | CYLINDER | CAPACITY | YEAR    |
|----------------------------|----------------|----------|----------|---------|
| 271 130 - 7<br>276 125 - 2 | TD 122, TD 123 | 6        | 11980    | 1987 ON |

OTHER NO.

08-24875-04,  
755.648

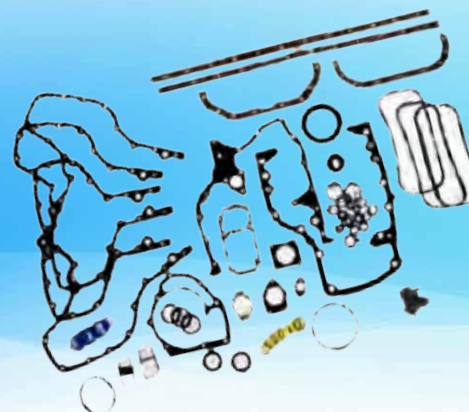

Suitable for

Bottom Gasket Set

**VOLVO**

TRUSTTEC NO. 016.01.0375

| OEM NO.     | APPLICATION  | CYLINDER | CAPACITY | YEAR    |
|-------------|--------------|----------|----------|---------|
| 270 775 - 0 | TD 71, TD 73 | 6        | 6730     | 1985 ON |

OTHER NO.  
08-24837-04,  
755.540

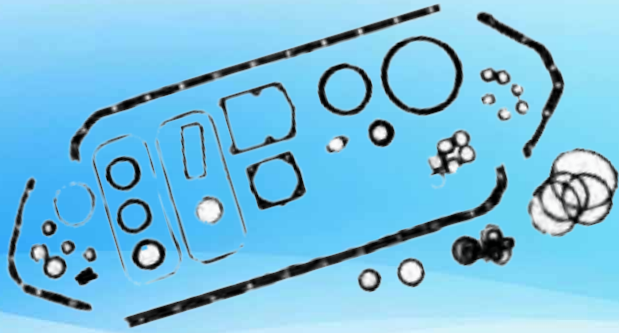

TRUSTTEC NO. 016.01.0376

| OEM NO.     | APPLICATION  | CYLINDER | CAPACITY | YEAR    |
|-------------|--------------|----------|----------|---------|
| 270 774 - 3 | TD 61, TD 63 | 6        | 5480     | 1986 ON |

OTHER NO.  
08-25034-05,  
754.811

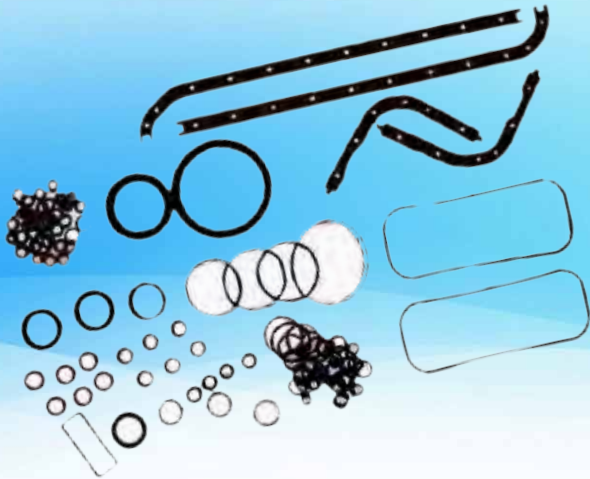

Suitable for

Bottom Gasket Set

**VOLVO**

TRUSTTEC NO. 016.01.0377

| OEM NO.     | APPLICATION  | CYLINDER | CAPACITY | YEAR      |
|-------------|--------------|----------|----------|-----------|
| 270 277 - 6 | D 70, TD 70, | 6        | 6700     | 1966-1978 |

OTHER NO.  
08-24837-06,  
318.826

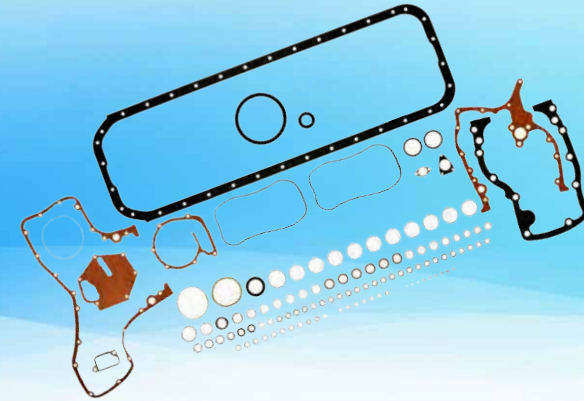

TRUSTTEC NO. 016.01.0378

| OEMNO.   | APPLICATION   | CYLINDER | CAPACITY | YEAR    |
|----------|---|----------|----------|---------|
| 275548-6 | TD120A, TD120C, TD120D, TD120E, TD120F,<br>TD120FC, TD120G, TD120GA, TD121F,<br>TD121FD, TD121FK, TD121G, TD121GA,<br>TD121GD | 6        | 11980    | 1977-86 |

OTHER NO.  
571.254

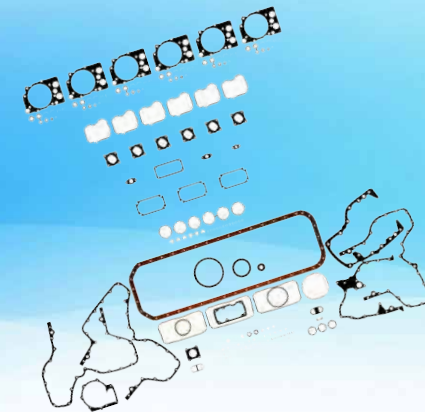

VOLVO

TRUSTTEC NO. 016.01.0379

| OEM NO. | APPLICATION   | CYLINDER | CAPACITY | YEAR    |
|---------|---|----------|----------|---------|
|         | D100A, TD100A,<br>D100B, TD100A,<br>TD100B, TD100BG | 6        | 9600     | 1966-80 |

OTHER NO.  
563.502  
922.323

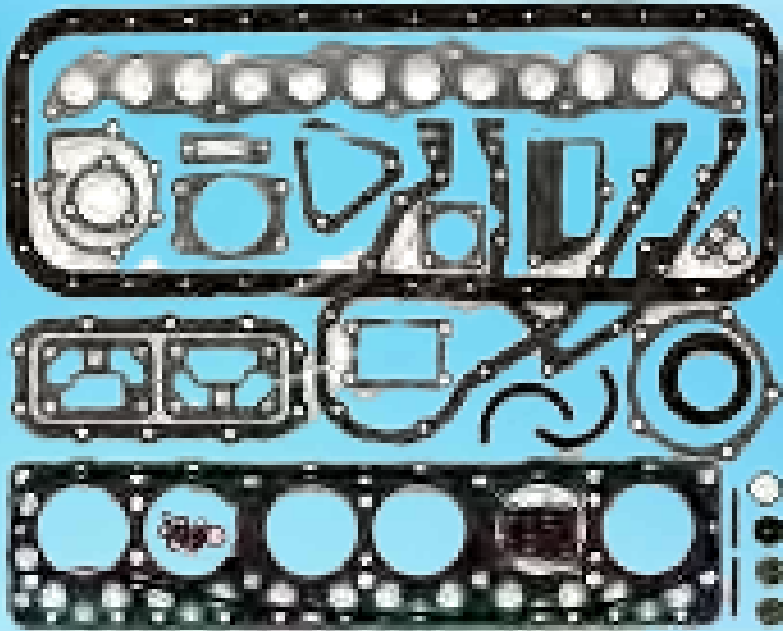

016.01.0379-1 (Qty.06)



016.01.0379-2 (Qty. 01)



016.01.0379-3 (Qty. 01)



016.01.0379-4 (Qty. 01)



016.01.0379-5 (Qty. 01)



016.01.0379-6 (Qty. 01)



016.01.0379-7 (Qty.01)



016.01.0379-8 (Qty.01)



016.01.0379-9 (Qty.01)



016.01.0379-11 (Qty.01)

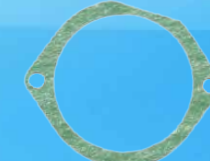

016.01.0379-12 (Qty.01)



016.01.0379-13 (Qty.06)



016.01.0379-14 (Qty.06)



016.01.0379-10 (Qty. 01)



380 54 57 05 (Qty. 01)



380 55 62 01 (Qty. 02)



380 55 66 01 (Qty. 06)



380 55 71 02 (Qty. 01)



G4-4224 (Qty. 01)



016.01.0379-11 (Qty. 01)

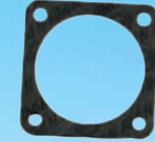

016.01.0379-12 (Qty. 01)



016.01.0379-13 (Qty. 01)



016.01.0379-14 (Qty. 06)



016.01.0379-15 (Qty. 01)



016.01.0379-16 (Qty. 01)

| WASHER & O-RING DETAILS-ORDER BY SIZE     |      |  |
|---|------|--|
| Description                               | Qty. |  |
| G3-4223 FELT RING 155X167X4.5 380548901   | 1    |  |
| G4-3739 SIL RUB BLK                       | 1    |  |
| G4-3491 GASK AVB 380516101 3 MM THK       | 3    |  |
| G4-3738 SEAL ASB 380516601 42X37X3        | 1    |  |
| A-3856 3.5 MM NITRILE BLK (42X35) M.P.    | 1    |  |
| G4-3514/1 TEFLON WASHER BLUE SIZE-        | 6    |  |
| G4-3514/2 TEFLON WAS. BLUE "1.5 540167001 | 12   |  |
| G4-3514/3 TEFLON/WA BLUE 540168201        | 1    |  |
| G4-3593/2 NIT.BLK 50.8X44.8X3 380597702   | 1    |  |
| G4-3748/2 ASR 36.6X28X4.3 380546701       | 1    |  |
| G4-3749/3 SEAL ASB 380544301 37X31X3      | 6    |  |
| G4-3737 SEAL SILICON RUB BLACK            | 1    |  |
| G4-3727 ORING AVB 380617501 32X26X3       | 2    |  |
| G4-3515 VITON RUB BLACK                   | 3    |  |
| G4-3738 VITON RUB BLACK                   | 1    |  |
| G4-3560 SEAL AVB 380547001 28X22X3        | 2    |  |
| G4-3443 SEAL NITRILE RUB. BLK             | 1    |  |
| G4-3733/2 O-RING AVB 440716201            | 3    |  |
| G4-3504 O-RING 65X3 ANB 540167701         | 1    |  |
| G4-3749/2 SEAL AVB 380544101 51X45X3      | 1    |  |
| G4-4740 POLY.GREEN COL. (MOULDOPG4-3562)  | 1    |  |
| G4-3562 O RING APB 380617501 30X24X3      | 1    |  |

| WASHER & O-RING DETAILS-ORDER BY SIZE     |      |  |
|---|------|--|
| Description                               | Qty. |  |
| G4-4558 VITON RUB. BLACK, 380559101       | 2    |  |
| Seal Ring G4-4210 (18x28x7.0)Poly.        | 1    |  |
| G4-3441 SEAL ANB 380596801                | 6    |  |
| G4-4741 VITON PURPLE(MOULDOFG4-3508)      | 1    |  |
| G4-3568 VITON RUB BLK 380568901           | 1    |  |
| G4-3749/1 SEAL AVB 380547101 20X25X3      | 1    |  |
| G4-1421 ASB                               | 1    |  |
| G3-3580/12CU WAS. 22.1X28.8X1.3 38058WL01 | 5    |  |
| G3-3580/10CU WAS 19.3X25.8X1.3 38058WJ01  | 1    |  |
| G3-3580/9CU WAS. 18.1X23.8X1.3 38058WV01  | 3    |  |
| CU WASHER 21.8X16.3 G3-4038901            | 3    |  |
| CU WSR 14.1 X 19.9 X 1.50 MM              | 11   |  |
| G4-4252/3 CU WAS. 10.2X16.0X.8 38056WC01  | 4    |  |
| CU WSR 14.1X17.9X1.30 MM G4-3580/4        | 19   |  |
| AL WASHER 12.2X15.4 G3-3512/14" 1.3       | 3    |  |
| AL WASHER 10X13.3 G4-3763/5" 0.9          | 2    |  |
| AL WASHER 8.35X11.3 G4-3763/6" 0.9        | 15   |  |
| G4-4252/1 AL WAS. 21.8X18.4X1.3 38056WA01 | 1    |  |
| G3-3580/5CU WAS 12.1X17.9X1.3 38058WE01   | 5    |  |
| 11.20 X 17.80 X 1.35 MM COPPER            | 2    |  |
| G3-3580/1CU WAS. 8X11.3X0.8 38058WA01     | 3    |  |
| G4-4207 ORING 64.7X76.1X5.7 ASR 380566701 | 1    |  |



016.01.0379-17 (Qty. 12)



016.01.0379-18 (Qty. 12)



016.01.0379-19 (Qty. 12)



016.01.0379-20 (Qty. 01)



016.01.0379-21 (Qty. 12)



016.01.0379-22 (Qty. 01)



016.01.0379-23 (Qty. 06)



016.01.0379-24 (Qty. 01)



016.01.0379-25 (Qty. 06)



016.01.0379-26 (Qty. 12)



016.01.0379-27 (Qty. 26)



016.01.0379-28 (Qty. 06)



016.01.0379-29 (Qty. 01)



VOLVO

TRUSTTEC NO. 016.01.0381

| OEM NO.   | APPLICATION  | CYLINDER | CAPACITY | YEAR    |
|-----------|--|----------|----------|---------|
|           | TD101F, TD101FA, TD101FC, TD101FD, TD101G, TD101GA, TD102F, TD102FD, TD102FF, TD102FL, TD102FM | 6        | 9600     | 1973-89 |
| OTHER NO. |  |          |          |         |
| 917.060   |  |          |          |         |

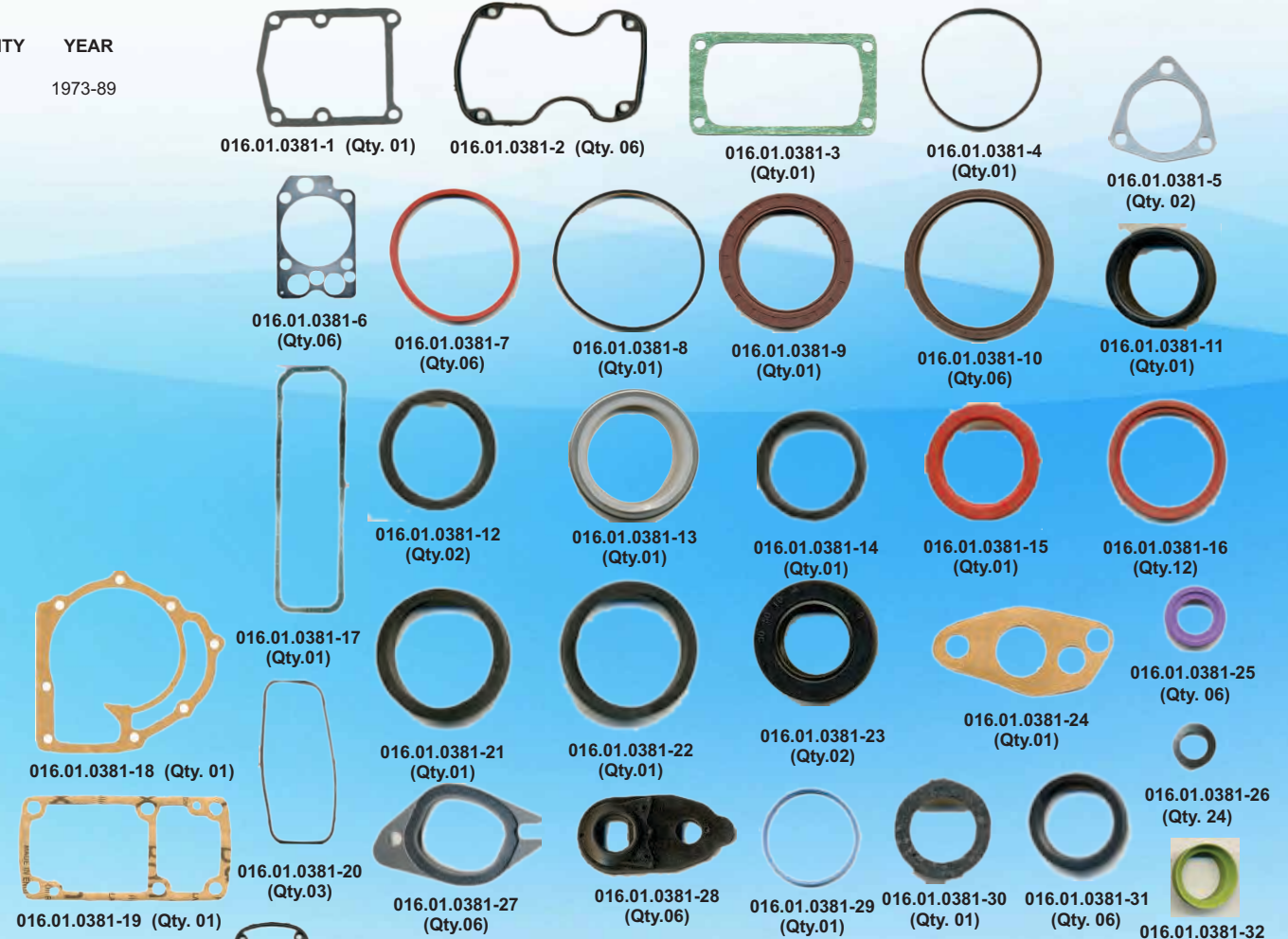

| O-RING DETAILS-ORDER BY SIZE             |      |
|--|------|
| Description                              | Qty. |
| G4-3528, O-RING NIT.BLK 220768601        | 1    |
| G4-4207ORING 64.7X76.1X5.7 ASR 380566701 | 1    |
| G4-3504, O-RING 65X3 ANB 540167701       | 3    |
| G4-3727 ORING AVB 380617501 32X26X3      | 1    |
| G4-3562 O RING APB 380617601 30X24X3     | 2    |
| G4-3296 O-RING ANB                       | 1    |
| G4-3440 O RING SIL RUB RED COL           | 2    |
| G4-3475 O RING SIL RUB RED COL           | 1    |
| G4-3493, O-RING, NIT. RUB. 540166201     | 3    |
| G4-3593/2 NIT.BLK. 50.8X44.8X3 380597702 | 1    |
| G5-1897 NITRILE BLK 380606501            | 1    |
| G4-4553, SILICON RUB. PAN. 173U (RED)    | 1    |

| WASHER DETAILS- ORDER BY SIZE            |      |
|--|------|
| Description                              | Qty. |
| G4-3514/1, TEFLON WASHER, BLUE SIZE:-    | 10   |
| G3-3580/13AL WAS 22.2X26.8X1.3 38058WM01 | 1    |
| G4-4252/1 AL WAS 21.8X18.4X1.3 38058WA01 | 1    |
| G3-3580/8CU WAS 20.3X23.8X1.3 38058WH01  | 1    |
| G3-3580/12CU WAS 22.1X28.8X1.3 38058WL01 | 3    |
| G3-3580/9CU WAS 18.1X23.8X1.3 38058WI01  | 4    |
| G3-3580/5CU WAS 12.3X17.8X1.3 38058WE01  | 8    |
| G4-3599 CU WASHER 10.4 X 15.8 * 1.3      | 4    |
| G3-3580/2CU WAS 10.1X13.3X0.8 38058WB01  | 1    |
| 14.2X19.8 CUWASHER G3-3512/18 * 1.4      | 23   |
| AL WASHER 22.9 X 29.9 X 1.35 MM          | 1    |
| AL WASHER 11.5X17.8 G4-3763/3 * 1.5      | 2    |
| 19.0X25.8X2.0 CRCA WITH ZINC PLATING     | 2    |
| 16.3X21.8X1.5 CRCA WITH ZINC PLATING     | 2    |
| 24.30 X 31.0 X 1.80 MM COPPER            | 1    |
| CU WASHER 11.4X8 G3-3512/8 * 0.8         | 4    |

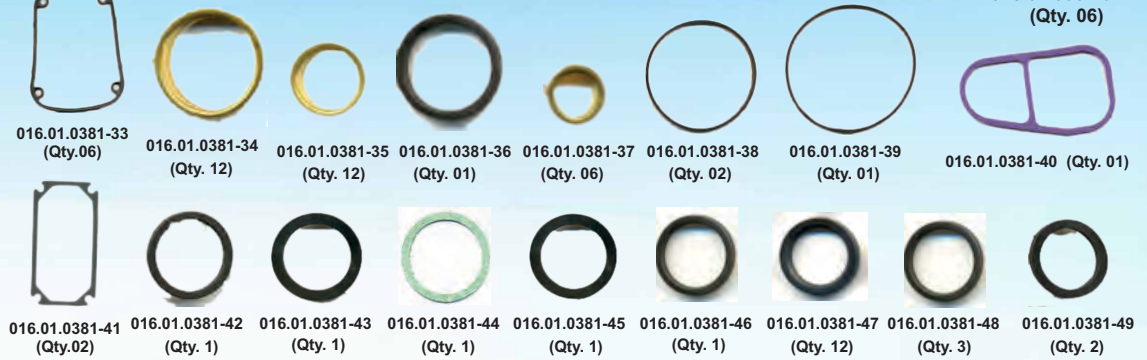



# Suitable for Decarbonizing Kit

## VOLVO

TRUSTTEC NO. 016.01.0383

OEM NO.  
270 770 - 1  
OTHER NO.  
108.074

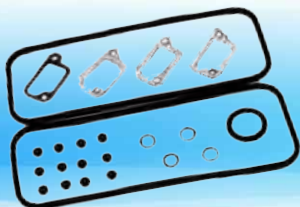

| APPLICATION              | CYLINDER | CAPACITY |
|--------------------------|----------|----------|
| D 50, D 60, TD 50, TD 60 | 6        | 5480     |

TRUSTTEC NO. 016.01.0384

OEM NO.  
275 554-4  
OTHER NO.  
087.343

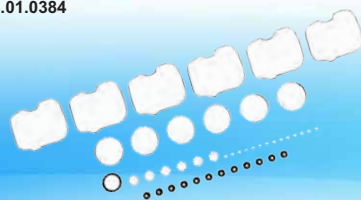

| APPLICATION    | CYLINDER | CAPACITY |
|----------------|----------|----------|
| TD 120, TD 121 | 6        | 11980    |

TRUSTTEC NO. 016.01.0385

OEM NO.  
276 034 - 6  
OTHER NO.  
087.299

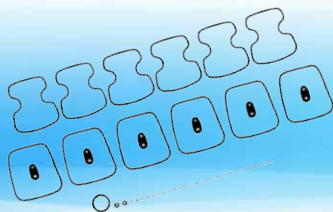

| APPLICATION     | CYLINDER | CAPACITY |
|-----------------|----------|----------|
| TD 100, TD 101, | 6        |          |

TRUSTTEC NO. 016.01.0386

OEM NO.  
275 533 - 8  
OTHER NO.

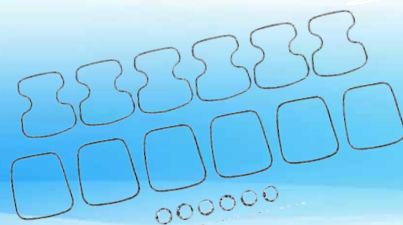

| APPLICATION    | CYLINDER | CAPACITY |
|----------------|----------|----------|
| TD 100, TD 101 | 6        |          |

# Suitable for Decarbonizing Kit

## VOLVO

TRUSTTEC NO. 016.01.0387

OEM NO.  
276 035 - 3  
OTHER NO.  
563.252

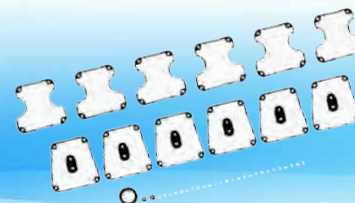

| APPLICATION            | CYLINDER | CAPACITY |
|------------------------|----------|----------|
| TD 101, TD 102, TD 103 | 6        | 9600     |

TRUSTTEC NO. 016.01.0388

OEM NO.  
275 781-3  
OTHER NO.

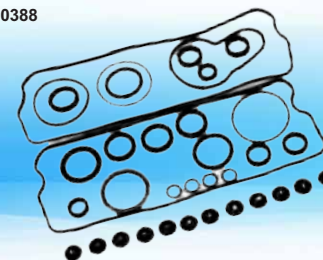

| APPLICATION  | CYLINDER | CAPACITY |
|--------------|----------|----------|
| TD 71, TD 73 | 6        | 6730     |

TRUSTTEC NO. 016.01.0389

OEM NO.  
275 776 - 3  
OTHER NO.  
754.927

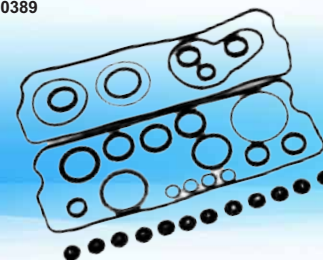

| APPLICATION   | CYLINDER | CAPACITY |
|---------------|----------|----------|
| TD 61, TD 63, | 6        | 5480     |

TRUSTTEC NO. 016.01.0390

OEM NO.  
270 761 - 0  
OTHER NO.  
108.066



| APPLICATION | CYLINDER | CAPACITY |
|-------------|----------|----------|
| D 70, TD 70 | 6        | 6700     |

Suitable for

Exhaust Manifold

**VOLVO**

TRUSTTEC NO. 016.01.0391

OEM NO.

470 534 - 9

OTHER NO.

527.319

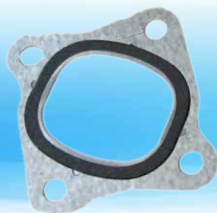

| APPLICATION    | CYLINDER | CAPACITY |
|----------------|----------|----------|
| TD 120, TD 121 | 6        | 11980    |

TRUSTTEC NO. 016.01.0392

OEM NO.

424 634-4

OTHER NO.

756.164

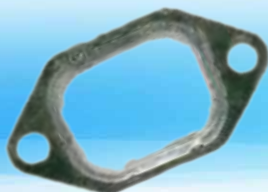

| APPLICATION    | CYLINDER | CAPACITY |
|----------------|----------|----------|
| TD 100, TD 101 | 6        |          |

TRUSTTEC NO. 016.01.0393

OEM NO.

471 650 - 2

OTHER NO.

755.044



| APPLICATION   | CYLINDER | CAPACITY |
|---------------|----------|----------|
| TD 71, TD 73, |          | 6730     |

Suitable for

Exhaust Manifold

**VOLVO**

TRUSTTEC NO. 016.01.0395

OEM NO.

420 708-0

OTHER NO.



| APPLICATION                 | CYLINDER | CAPACITY |
|-----------------------------|----------|----------|
| D 50, D 60, TD 50,<br>TD 60 | 6        | 5480     |

TRUSTTEC NO. 016.01.0396

OEM NO.

420 538-1

OTHER NO.



| APPLICATION  | CYLINDER | CAPACITY |
|--------------|----------|----------|
| TD 61, TD 63 | 6        | 5480     |

TRUSTTEC NO. 016.01.0397

OEM NO.

479 107-5

OTHER NO.

834.238



| APPLICATION               | CYLINDER | CAPACITY |
|---------------------------|----------|----------|
| TD 101, TD 102,<br>TD 103 | 6        | 9600     |

TRUSTTEC NO. 016.01.0398

OEM NO.

421 534 - 9

OTHER NO.

693.731



| APPLICATION               | CYLINDER | CAPACITY |
|---------------------------|----------|----------|
| TD 101, TD 102,<br>TD 103 | 6        | 9600     |

Suitable for

Intake Manifold

**VOLVO**

TRUSTTEC NO. 016.01.0399

OEM NO.

424 611-2

OTHER NO.

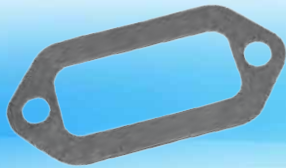

APPLICATION

D 50, D 60, TD 50,  
TD 60

CYLINDER

6

CAPACITY

5480

Suitable for

Manifold Gasket Kit

**VOLVO**

TRUSTTEC NO.016.01.0400

OEM NO.

270 769-3

OTHER NO.



APPLICATION

D 50, D 60, TD 50,  
TD 60

CYLINDER

6

CAPACITY

5480

TRUSTTEC NO. 016.01.0401

OEM NO.

270 768 - 5

OTHER NO.

315.720



APPLICATION

D 50, D 60, TD 50,  
TD 60

CYLINDER

6

CAPACITY

5480

TRUSTTEC NO. 016.01.0402

OEM NO.

270 772 - 7

OTHER NO.

087.352

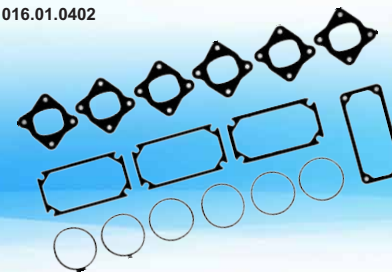

APPLICATION

TD 120, TD 121

CYLINDER

6

CAPACITY

11980

TRUSTTEC NO. 016.01.0403

OEM NO.

270 958 - 2

OTHER NO.

087.301



APPLICATION

TD 100, TD 101,

CYLINDER

6

CAPACITY

# Suitable for

# Intake Manifold

## VOLVO

TRUSTTEC NO. 016.01.0404

**OEM NO.**

276 052 - 8

**OTHER NO.**

563.260

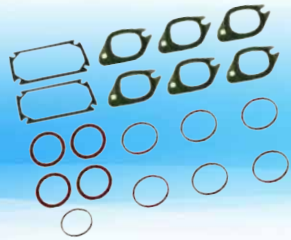

| APPLICATION            | CYLINDER | CAPACITY |
|------------------------|----------|----------|
| TD 101, TD 102, TD 103 | 6        | 9600     |

TRUSTTEC NO. 016.01.0405

**OEM NO.**

270 765 - 1

**OTHER NO.**

755.052

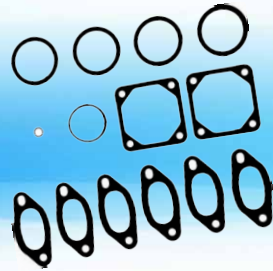

| APPLICATION  | CYLINDER | CAPACITY |
|--------------|----------|----------|
| TD 71, TD 73 | 6        | 6730     |

TRUSTTEC NO. 016.01.0406

**OEM NO.**

270 764 - 4

**OTHER NO.**

754.617

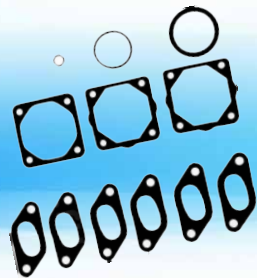

| APPLICATION  | CYLINDER | CAPACITY |
|--------------|----------|----------|
| TD 61, TD 63 | 6        | 5480     |

TRUSTTEC NO. 016.01.0407

**OEM NO.**

270 771 - 9

**OTHER NO.**

108.147



| APPLICATION  | CYLINDER | CAPACITY |
|--------------|----------|----------|
| D 70, TD 70, | 6        | 6700     |

# Suitable for

# Valve Cover Gasket

## VOLVO

TRUSTTEC NO. 016.01.0408

**OEM NO.**

423 145 - 2

**OTHER NO.**

088.161



| APPLICATION    | CYLINDER | CAPACITY |
|----------------|----------|----------|
| TD 100, TD 101 | 6        |          |

TRUSTTEC NO. 016.01.0409

**OEM NO.**

423 146 - 0

**OTHER NO.**



| APPLICATION    | CYLINDER | CAPACITY |
|----------------|----------|----------|
| TD 100, TD 101 | 6        |          |

TRUSTTEC NO. 016.01.0410

**OEM NO.**

424 693-0

**OTHER NO.**

776.476



| APPLICATION            | CYLINDER | CAPACITY |
|------------------------|----------|----------|
| TD 101, TD 102, TD 103 | 6        | 9600     |

TRUSTTEC NO. 016.01.0411

**OEM NO.**

424 694 - 8

**OTHER NO.**

776.483



| APPLICATION            | CYLINDER | CAPACITY |
|------------------------|----------|----------|
| TD 101, TD 102, TD 103 | 6        | 9600     |

Suitable for

# Valve Cover Gasket

## VOLVO

TRUSTTEC NO. 016.01.0412

OEM NO.

424 692 - 2

OTHER NO.

776.468

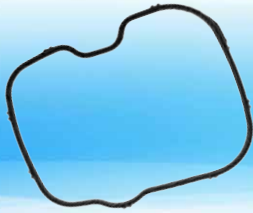

| APPLICATION    | CYLINDER | CAPACITY |
|----------------|----------|----------|
| TD 122, TD 123 | 6        | 11980    |

TRUSTTEC NO. 016.01.0413

OEM NO.

471 520 - 7

OTHER NO.

756.504

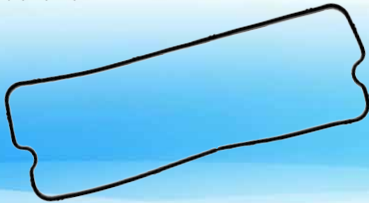

| APPLICATION  | CYLINDER | CAPACITY |
|--------------|----------|----------|
| TD 71, TD 73 | 6        | 6730     |

TRUSTTEC NO. 016.01.0414

OEM NO.

421 066 - 2

OTHER NO.

104.213

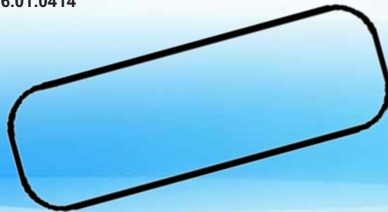

| APPLICATION  | CYLINDER | CAPACITY |
|--------------|----------|----------|
| D 70, TD 70, | 6        | 6700     |

# Seal, Coolant Pipe

TRUSTTEC NO. 016.01.0415

OEM NO.

270 771 - 9

OTHER NO.

108.147



| APPLICATION    | CYLINDER | CAPACITY |
|----------------|----------|----------|
| TD 100, TD 101 | 6        |          |