

TRUSTTEC®

www.trusttec.eu



FORD GMC

Parts catalogue

ISO 9001:2015
IATF 16949:2016

GENERAL MOTORS



ARM ASY-LOWER-LH
1999-2006
92081620
07-81620



ARM ASY-LOWER-RH
1999-2006
92081621
07-81621



ARM ASY-LOWER-LH
2007-2011
92183309
07-3309



ARM ASY-LOWER-RH
2007-2011
92183310
07-3310



STB-LINK-KIT-LH
2006-2006
92166403
07-6403



STB-LINK-KIT-RH
2005-2006
92166404
07-6404



STB-LINK-KIT-LH
2007-2011
92246135
07-6135



STB-LINK-KIT-RH
2007-2011
92246136
07-5959



STB-LINK-KIT REAR-LH+RH
2007-2011
92195849
07-5849



STB-LIK-KIT-LH+RH
2002-2004
92078631
07-8631



INNER SHAFT-LH+RH
1999-2006
92143047
07-3047



INNER SHAFT-LH+RH
2007-2011
92198273
07-8273



TIE ROD END OUTER-LH+RH
1999-2006
92143049
07-3049



TIE ROD END OUTER-LH
2007-2011
92198274
07-8274



TIE ROD END OUTER RH
2007-2011
92198275
07-8275



BUSH-CHS-TENSION ROD
1999-2006
92047105
07-7105



BUSH-BIG-CHASSIS-TENSION
ROD
1999-2006
92039329
07-9329



BUSH-SMALL-CHASSIS-
TENSION ROD
1999-2006
9947213
07-7213



MOUNT-SHOCK
1999-2011
92148903
07-8903



BEARING-MOUNT
1999-2011
92046063
07-6063



COUPLING KIT, W/BOLT
1999-2011
92143593
07-3593



COUPLING KIT W/BOLT
1999-2011
92143598
07-3598



BEARING-PROP. SHAFT
1999-2011
92143761
07-3761



BOOT - TIE ROD
1999-2006
92146712
07-6712



INSULATOR-MUFFLER
1999-2011
92186996
07-6996



INSULATOR-STB LINK KIT
2002-2005
92159373
07-9373



BEARING-AXLE-REAR
1999-2006
92077119
07-7119



BEARING-AXLE-REAR
2007-2011
92171057
07-1057



BOOT-AXLE-REAR
1999-2011
92148954
07-8954



ENGINE MOUNT-V8
2000-2006
92084910
07-4910



TRANS-MOUNT
1999-2011
92047224
07-7224



ENGINE-MOL V6-LH
2004-2010
92122591
07-2591



ENGINE-MOL. V6-RH
2004-2009
92122590
07-22590



ENGINE MOUNT-LH+RH-V6
1999-2003
22178767
07-8767

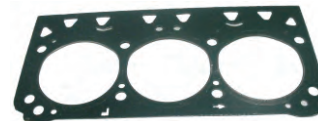

HEAD GASKET V6-LN3
1999-2004
24503801
07-3801

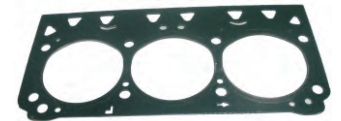

HEAD GASKET V6-LN3
1999-2004
24503802
07-3802



HEAD GASKET-LH V8-LS
1999-2006
12558809
07-8809



HEAD GASKET-RH-V8-LS
1999-2006
12558810
07-8810



BALL JOINT-LOW. ARM L-R
1999-2006
92057139
07-7139



GASKET EXH-MAINFOLD
2005-2011
MS95809-1
07-5809-1

CAPRICE - LUMINA-1999-2011

TRUSTTEC



GASKET EXH-MANIFOLD
1999-2011
MS92467-OEM-12600530
07-MS92467



GASKET-VALVE COVER-V8
1999-2011
12560696
07-0696

NO PHOTO

GASKET OIL ENG-PAN
1999-2011
12568750
07-8750

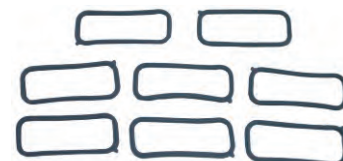

GASKET SET INLET M/F
1999-2011
12533587
07-3587



SEAL KIT P/S GEAR
1999-2006
92143488
07-3488



HEAD GASKET-V6
2005-2011
12624743
07-4743



HEAD GASKET-V6
2005-2011
12620190
07-0190



BUSHING SET
2007-2011
92159305
07-9305



BUSHING SET
2007-2011
92159311/92224662
07-4662



MOUNTING
92057224
07-7224



FRONT SPRING
INSULATOR
K6702, 15743856
07-6702



IDLER ARM
12471378, 19178433
K6534
07-1378



IDLER ARM
19153392, K6395
07-3392



PITMAN ARM
12471379, 19168944,
K6536
07-1379



FRONT SPRING UPPER
SEAT, 07-20,
CADILLAC ESCALADE
15803177, K160098
07-3177



FRONT STABILIZER
BAR BUSH, 08-16
92219337
07-9337



STABILIZER BAR
LINK, FRONT,
07-17+B1644
20905104
07-5104



STB BAR LINK KIT,
FRONT
22555477, K5252
07-5477



STB BAR LINK KIT,
FRONT
10385580, K80361
07-0361



STB BAR LINK KIT,
FRONT
25918049, K700432
07-0432

CAPRICE - LUMINA - 1999-2011

TRUSTTEC

GENERAL MOTORS



BALL JOINT UPPER
1980-1994
45D0016
07.0016



BALL JOINT LOWER
1980-1994
45D02026
07.2026



BALL JOINT
1992-1999
45D2223
07.2223



BALL JOINT
2000-2009
45D0103
07.0103



BALL JOINT
2000-2009
45D0104
07.0104

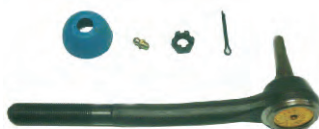

TIE ROD-OUTER
1980-1994
45A0184
07.0184

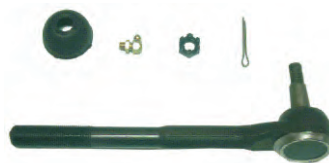

TIE ROD OUTER
1980-1994
45A0590
07.0590



TIR ROD OUT LH-RH
2000-2006
45A0785
07.0785



TIE ROD OUTER-LH+RH
2007-2011
45A01092
07.1092



INNER SHAFT LH+RH
2000-2006
45A0787
07.0787



INNER SHAFT LH+RH
2007-2011
19178561
07.8561



INNER SHAFT
2002-2011
45A0888
07.0888



STB LINK KIT
2002-2009
45G0254
07.0254



STB LINK KIT
2002-2009
45G0255
07.0255



STB LINK KIT
2002-2009
45G0467
07.0467



STB LINK KIT
2002-2009
45G0468
07-0468



STB LINK KIT
2002-2009
45G0252
07.0252



STB LINK KIT
2002-2009
45G0253
07.0253



TIE ROD END
2002-2009
45A0886
07.0886



TIE ROD END
2002-2009
45A0887
07.0887

GENERAL MOTORS



STB LINK KIT
2000-2006
10385580
07.5580



MOUNT-TRANS
1980-1996
472143
07.2143



MOUNT-ENGINE
2000-2006
25828247
07.8247



MOUNT-TRANS
2000-2006
15677858
07.7858



MOUNT-ENGINE
2007-2011
15854941
07.4941



DAMPER PULLY
2000-2006
12553112
07.3112

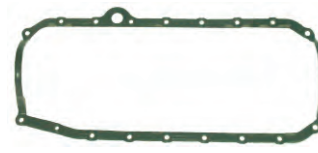

GASKET ENG OIL PAN
1987-1999
10108676
07.8676

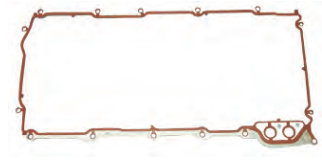

GASKET ENG OIL PAN
2000-2006
12580672
07.0672



GASKET-VALVE COVER
2000-2011
12560696
07.0696

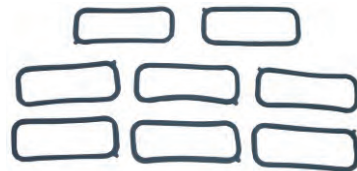

GASKET INLET M/F
2000-2011
12533587
07.3587



GASKET TRANS MT-1
1992-2011
8677743
07.7743



GASKET-DIFF 8.5RG
1992-1999
26016661
07.6661



GASKET -EXH-M/F
1980-1993
MS9275
07.9275



GASKET -EXH-M/F
1994-1996
MS95585
07.5585



GASKET-EXH-M/F
2000-2006
MS92211
07.2211



CABLE-P/BRAKE
2000-2006
15226269
07.6269



CABLE-P/BRAKE LH
2000-2006
15087071
34.15087071



CABLE P/BRAKE RH
2000-2006
15087072
07.7072



OUTLET HEATER WATER
1992-1999
15-30900
07.0900



BUSHES-ARM ASY
1980-1996
K6109
07.6109

CHEVROLET-CADILLAC-BUICK-HUMMER-OLDSMOBILE-PONTIC

TRUSTTEC

GENERAL MOTORS



BUSHES-ARM ASY
1980-1996
K6198
07.6198



BUSHES-ARM ASY UPPER
1992-1992
K6395
07.6395



BUSHES-ARM ASY LOWER
1992-1999
K6327
07.6327



BUSHES-ARM ASY UPPER
2002-2011
TBR-7475
07.7475



BUSHES-ARM ASY LOWER
2002-2011
TBR-7980
07.7980



BEARING
1980-1996
S6
07.2649



BEARING
1980-1995
S7
07.7048



BEARING
1980-1999
457052
07-S8



BEARING
1978-1999
S-20
07.1503



BEARING
1978-1999
S-21
07.1349



REAR ENGINE OIL SEAL
1999-2007
89060436
07.0436



FRONT ENGINE OIL SEAL
1999-2007
12585673
07.5673

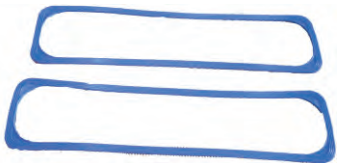

VALVE COVER GASKET
1994-1996
10046089
07.6089



PISTON WITH PIN
H840CP
07.40CP



SEAL KIT A/C CMPR
15-2292
07.2292



SEAL KIT
15-2720
07.2720



SEAL KIT
15-2723
07.2723



SEAL WASHER KIT
2724887
07.4887



BUSHING
810620
07.0620



SPRING
7812853
07.2853

CHEVROLET-CADILLAC-BUICK-HUMMER-OLDSMOBILE-PONTIAC

TRUSTTEC

GENERAL MOTORS

CHEVROLET-CADILLAC-BUICK-HUMMER-OLDSMOBILE-PONTIC

TRUSTTEC



SEAL WASHER KIT
2724577
07.4577



GASKET
12600530
07.0530



TIE ROD ADJUSTING SLEEVE
ACD 45A6004/88910750
07.0750



BEARING KIT FOR DIFF
07.4041S



DIFF LOCK PIN
14006401
07.6401



CON ROD
12568734
07.8734



CON ROD
12569110
07.9110



VALVE SEAL SET
SS71043-1
07.4151S



VALVE SEAL SET INLET
S-71039
07.4151S



VALVE SEAL EX
S-71040
07.4152EX



VALVE SEAL VS
1644
07.4153S



VALVE SEAL 4.6L V8
2005-2007
(SET OF 24)
SS72921-1
07.2921



VALVE SEAL 5.3L V6
200-2009
(SET OF 24)
SS71237
07.1237



IDLER ARM
45C1042/88911296
07.1296



PITMAN ARM
45C0069/89000779
07.0779



IDLER ARM
45C1120/59000786
07.1120



PITMAN ARM
45C0064/88911249
07.1249



BALL JOINT
45D2272/89049532
07.9532



STB BUSH
15128365
07.8365



CONTROL ARM
BUSHING KIT, 92-94
15567827 / #K6329
07-7827

GENERAL MOTORS



CONTROL ARM BUSHING
14049624 / K-6333
07-9624



FRONT LOWER CONTROL ARM BUSHING, BLAZER
15980176 / K-6176
07-0176



CONTROL ARM BUSHING
DW-K6137B
07-6137



CONTROL ARM BUSHING 95-02
K-6283
07-6283



CONTROL ARM BUSHING
K-6282B
07-6282B



CONTROL ARM BUSHING
K-6138B
07-6138B



CONTROL ARM BUSHING
K-6411
07-6411



CONTROL ARM BUSHING
K-6176
07-6176



CONTROL ARM BUSHING
K-6283
07-6283



CONTROL ARM BUSHING
K-6177B
07-6177B



CONTROL ARM BUSHING
K-6137
07-6137



CONTROL ARM BUSHING
K-6417
07-6417



CONTROL ARM BUSHING
K-6138
07-6138



CONTROL ARM BUSHING
K-6420
07-6420



CONTROL ARM BUSHING
14073311 / K-7104
07-7104



CONTROL ARM BUSHING KIT, FRONT, UPPER
K6418
07-6418



BUSHING LOWER CONTROL ARM, 98-02
88876486 / K80029
07-6486



CONTROL ARM BUSH, FRONT, LOWER
89020257, 45G9222
07-0257



CONTROL ARM FRONT/REAR, LOWER
89033035, 45G9212
07-3035



SUSPENSION BUSH, FRONT, LOWER
89033036, 45G9213
07-3036

GENERAL MOTORS



CONTROL ARM BUSH,FRONT,UPPER
15522522, K6323
07-6323



CONTROL ARM BUSH,FRONT,LOWER
15567821,K6327
07-6327



CONTROL ARM BUSH,FRONT,UPPER
15607586, K6395
07-6395



CONTROL ARM BUSH,FRONT
15005612, K6439
07-6439



CONTROL ARM BUSH,FRONT
14071381, K6408
07-6408



DIFF CARRIER BUSH,FRONT
23104736, K201736
07-4736



BUSHING,LOWER CONTROL ARM,FRONT,ACADIA,07-17
25798013, 25798014,K201220
07-1220



FRONT LOWER CONTROL ARM BUSHING
22782549,22738921,
15897963,K201187
07-1187



CONTROL ARM RH
RK640293,1507724
5,22786775
07-6775



CONTROL ARM TRAIL BLAZER LH
RK640294,15077244,22786774
07-6774



CONTROL ARM, FRONT,UPPER,LH, ESCALADE
25812725, 15096197
07-2725



CONTROL ARM, FRONT,UPPER,RH, ESCALADE
25812726,15096198
07-2726



CONTROL ARM, FRONT,UPPER,14-20,RH
84628488
07-8488



CONTROL ARM, FRONT,UPPER,14-20,LH
84628487
07-8487



CONTROL ARM, FRONT,LOWER,RIGHT,
07-17
20774419,25798011
07-4419



CONTROL ARM, FRONT,LOWER, LEFT,
07-17
25995438
07-5438



BUSH,TRAIL BLAZER
2000-2010
12200270/19133553/
15018251
K200270/19133554
07-3554



CONTROL ARM WITH BALL JOINT
K-6147
07-6147



FRONT LOWER SUSPENSION BALL JOINT LOWER
22157319/45D2296
07-7319



FRONT LOWER SUSPENSION BALL JOINT UPPER
K6664,19133638
07-6664

CHEVROLET-CADILLAC-BUICK-HUMMER-OLDSMOBILE-PONTIC

TRUSTTEC

GENERAL MOTORS



BALL JOINT,FRONT,
UPPER,RH/LH
89050133
07-0133



BALL JOINT,
UPPER,RH/LH
89050151
07-0151



BALL JOINT,FRONT,
LOWER,14-16
CADILLAC ESCALADE
22855747/K500007
07-0007



BALL JOINT, LOWER
15616427/K6445
15657212/15617643
15659724
07-9724



BALL JOINT FRONT,UPPER
15575901/15634385/1563490
4 15687080/K6262
07-6262



BALL JOINT,
FRONT,UPPER
88876220, K6540
07-6540



BALL JOINT,FRONT,
LOWER, LH/RH
89049532, 45D2272
07-9532



BALL JOINT,
FRONT,LOWER
12475477, K6693
07-5477



BALL JOINT,
FRONT,LOWER
22855747
07-5747



STB TRAIL BLAZER 02-03
FRONT RIGHT
K6665,45G0252,88876413
07-6665



STABILIZER TRAIL BLAZER
02-03 FRONT LEFT
K6666,12479075
07-6666



STABILIZER TRAIL BLAZER
02-09 RIGHT
K6667,15071424
07-6667



STABILIZER TRAIL
BLAZER 02-09 RIGHT
K6668,15071423
07-6668



STABILIZER BLAZER
GMC 04-07,LEFT
K80824,15102674
07-2674



STABILIZER BLAZER
GMC 04-07,RIGHT
K80825,15106273
07-6273



INNER ROD TRAIL
BLAZER 2002-2009
EV80968,26100288
07-0288



TIE ROD END
INNER,14-17,CAPRICE
92274700 / EV801222
07-4700



TIE ROD END
92286152
07-6152



TIE ROD END
92286153
07-6153



TIE ROD END,
OUTER,RH/LH
22868912, ES800948
07-8912

GENERAL MOTORS

CHEVROLET-CADILLAC-BUICK-HUMMER-OLDSMOBILE-PONTIC

TRUSTTEC



TIE ROD END, TRAIL BLAZER
02-09, YUKON 06-09
ES3676, 26100287
07-3676



TIE ROD END,
STEERING LINKAGE
89000732, 45A0785
07-0785



TIE ROD END,
STEERING LINKAGE
19195659/15244061/45A1092
07-5659



TIE ROD END,
OUTER, CADILLAC
22868912, ES800948
07-0948



TIE ROD END, TRAIL BLAZER
02-09, YUKON 06-09
ES3675/26100286/M16x1.50mm
07-3675



STEERING
LINKAGE, INNER
15295861, ES3488
07-3488



STEERING
LINKAGE, INNER
19178561
07-8561



STEERING
LINKAGE, INNER
22834082/ES800938
07-4082



STEERING LINKAGE,
INNER, CHEVY BUICK
09-17
20817752, EV800572
07-7752



STEERING LINKAGE
SIERRA, 2018
EV800938
07-0938



STEERING LINKAGE,
INNER, CHRYSLER, 06-10
68028831AB
08-8831AB



STEERING LINKAGE
INNER, CHRYSLER, 06-10
19460410
07-0410



ENGINE MOUNT
TRAIL BLAZER 02-10
15062381
07-2381



SHOCK MOUNT, FRONT
UPPER, 14-20
22826284
07-6284



ENGINE MOUNT,
07-14
15854939
07-4939



ENGINE MOUNT
14-19, DRIVER SIDE
84175581
07-5581



ENGINE MOUNT 14-19,
PASSENGER SIDE
84175582
07-5582



ENGINE MOUNT,
DRIVER SIDE, 15-20
54175583
07-5583



ENGINE MOUNT
FRONT, 09-17
25840452
07-0452



ENGINE
MOUNT, FRONT, 07-15
25840451, 84006114
07-0451

GENERAL MOTORS



ENGINE MOUNT, REAR,
09-17+B1674
25840450
07-0450



ENGINE MOUNT, FRONT
07-08
25857746
07-7746



ENGINE MOUNT, REAR
07-08
25857748
07-57748



TRANSMISSION MOUNT
2587750
07-57750



TRANSMISSION MOUNT
07-14
15840278
07-0278



STRUT, ENGINE MOUNT
09-17
25840458
07-0458

CHEVROLET-CADILLAC-BUICK-HUMMER-OLDSMOBILE-PONTIC

TRUSTTEC®



CLIPS BRAKE PAD
1992-1997
BRPK-5623
08.5623



CALIPER BOLT BIG
1992-1994
F4AZ 2B296A
08.2B296A



CALIPER BOLT SMALL
1995-1997
F5AZ 2B296A
08.2B296A

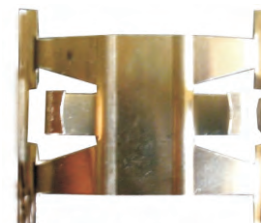

CLIPS BRAKE PAD
1998-2002
F8VZ 2B164A
08.2B164AD1



BOLT CALIPER
1998-2002
F8VZ 2B296A
08.2B296A



PARKING BRAKE CABLE
1992-2002
2W7Z 2853BA
08.2853BA



PARKING BRAKE CABLE
2003-2011
3W7Z 2853AA
08.2853AA



PARKING BRAKE CABLE
1998-2002
2W7Z 2A635DA
08.2A635DA



PARKING BRAKE CABLE
1998-2002
2W7Z 2A635GA
08.2A635GA



TIE ROD END OUTER
1992-2002
2W7Z 3A130AA
08.3A130AA



TIE ROD END OUTER
1992-2002
2W7Z 3A131AA
08.3A131AA



SLEEVE TIE ROD END
1992-2002
F7AZ 3310AA
08.3310AA



BALL JOINT LOWER
F8AZ 3050AA
08.3050AA



INNER SHAFT TIE ROD END
2003-2011
3W1Z 3280BA
08.3280BA



SHAFT
1992-2002
F8AZ 3B676AA
08.3B676AA



"U" JOINT ASTY
1995-2002
F2AZ 4635C
08.4635C



U-JOINT ASY
2003-2011
3W1Z 4635AA
08.4635AA



INSULATOR MUFFLER
2003-2011
3W1Z 5A242AA
08.5A242AA



PINION SHAFT LOCK
1989-2011
E9AZ 4211A
08.4211A



"U" WASHER PINION
2003-2011
C7AZ 4N237A
08.4N237A



SPIDER PINION KIT
1989-2011
5L1Z 4215A
08.4215A

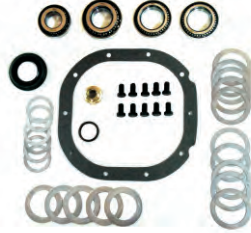

DIFF BEARING REP KIT
2003-2011
XW4Z 4210AAK
08.4210AAK



STB LINK KIT
1995-1997
F6AZ 5K484AA
08.5K484AA



STB LINK KIT
1998-2002
F8AZ 5K484AA
08.5K484AA



STABILAZER LINK KIT
2003-2011
3W1Z 5K484AA
08.5K484AA



ARM ASY UPPER
1998-2011
F8AZ 5500AA
08.5500AA



ARM ASY LOWER
1998-2011
F8AZ 5A649AA
08.5A649AA



STB LINK ASY REAR
1998-2011
6W1Z 4264AA
08.4264A



INSULATOR MUFFLER
1992-2002
F6VZ 5A242AA
08.5A242AA



GASKET EXH MANIFOLD
1992-2011
E9AZ 5E241A
08.5E241A



STB. BUSH
6L2Z 5484AA
08.5484AA



BEARING
3WW1Z 1225AA
08.1225AA

CROWN VICTORIA-GRAND MARQUIS-LINCOLN TOWN CAR-NAVIGATOR-EXPLORER-EXPEDITION

TRUSTTEC



INSULATOR COIL SRING
2003-2011
5W1Z 5415AA
08.5415AA

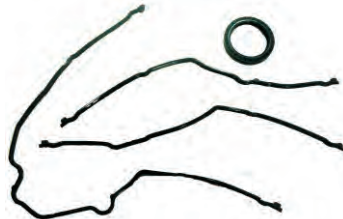

GASKET KIT T/ CASE
1992-1995
F1AZ 6020BK
08.6020BK



GASKET KIT T/CASE
1996-2011
F6AZ 6032A
08.6032A



ENGINE MOUNT
1992-1997
F4AZ-6038-A
08.6038A



ENGINE MOUNT
1992-1997
F4AZ 6038B
08.6038B

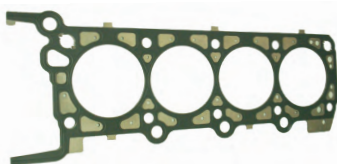

HEAD GASKET 2.2MM
1992-2011
4C2Z 6051AA
08.6051AA

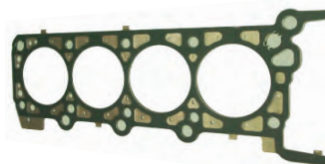

HEAD GASKET 2.2MM
1992-2011
4C2Z 6051BA
08.6051BA



OIL SEAL
1992-2011
F5AZ 6700A
08.6700A



OIL SEAL
1992-2011
F4AZ 6701A
08.6701A

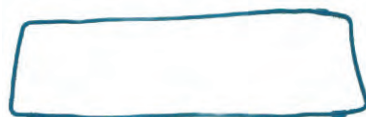

GASKET VALVE COVER
1992-2001
F6AZ 6584AA
08.6584AA



GASKET VALVE COVER
1992-2001
F6AZ 6584BA
08.6584BA



GASKET VALVE COVER
2002-2011
2C2Z 6584AA
08.6584AA



GASKET VALVE COVER
2002-2011
2C2Z 6584BA
08.6584BA



VALVE SEAL
1992-1995
F1AZ 6571A
08.6571A



VALVE SEAL 4.6LT
1996-2011
F6AZ 6571AA
08.6571AA



VALVE SEAL 4.6LT
2003-2011
F4AZ 6571AA
08.6571AA



DAMPER PULLEY 5.OLT
1989-1991
E4TZ 6316A
08.6316A



DAMPER PULLEY 4.6LT
1992-2000
F3AZ 6316A
08.6316A



DAMPER PULLEY
2001-2011
1W7Z 6312AA
08.6312AA



HYDRAULIC LIFTER PIPE
1992-2011
F6DZ 6C501A-HL7000S
08.6C501A



HYDRAULIC TENSIONER
1992-2011
6L266BA
08.6L266BA



HYDRAULIC TENSIONER
1992-2011
F6AZ 6L266DA
08.6L266DA

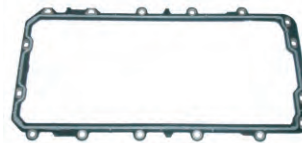

GASKET OIL PAN
1992-2009
3L3Z 6710AA
08.6710AA



OIL ADAPTOR
1992-2011
9W1Z 6881C / F1AZ 6881BA
08.6881C

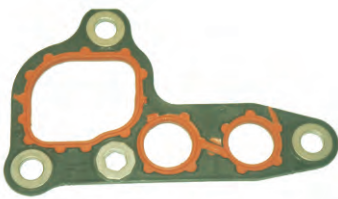

GASKET OIL ADAPTOR
1992-2002
F6AZ 6840AA
08.6840AA

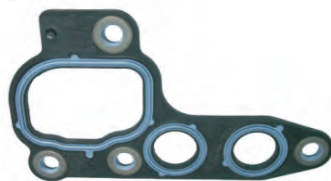

OIL ADAPTOR GASKET
2003-2011
F6AZ 6840BA
08.6840BA

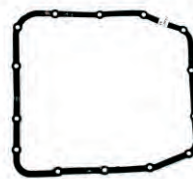

GASKET TRANS OIL PAN
1992-2011
F2VY 7A191AA
08.7A191AA



GASKET TRANS OIL PUMP
1992-2011
F2VY 7A136A
08.7A136A

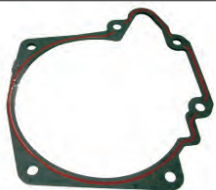

GASKET TRANS HOUSING
1992-2011
F7AZ 7086A
08.7086



VALVE GUIDE
1992-1994
VG-1389T
08.1389T



VALVE GUIDE
1995-2002
VG 8680
08.8680



BUSHING KIT
1995-2002
K8703
08.K8703

CROWN VICTORIA-GRAND MARQUIS-LINCOLN TOWN CAR-NAVIGATOR-EXPLORER-EXPEDITION

TRUSTTEC



BUSHING KIT
1998-2002
K80029
08.K80029



BUSHING KIT
1995-1997
K8297
08.K8297



BUSH UPPER ARM ASY
2003-2011
K8706
08.K8706



BUSHES UPPER ASY
2002-2005
6L1Z 3084AAA(K8707)
08.8707

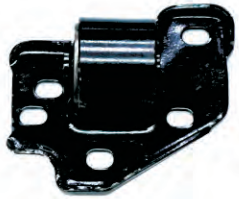

BUSHES UPPER ASY
2002-2005
6L2Z 3084AA(K8708)
08.8708



GASKET INLET MANIFOLD
1995-2001
XW7Z 9439AA
08.9439AA



GASKET INLET MANIFOLD
2002-2011
YL3Z 9439BA
08.9439BA



EXHAUST M/F GASKET
1996-2009
F5AZ 9448A
08.9448A

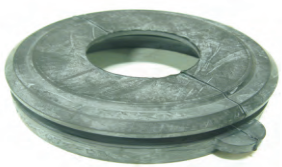

SAEL FUEL TANK
1992-1997
F4ZZ 9072A
08.9072A

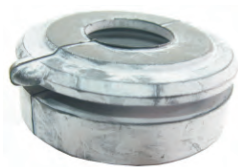

SEAL FUEL TANK
2003-2011
2R3Z 9072AA
08.9072AA

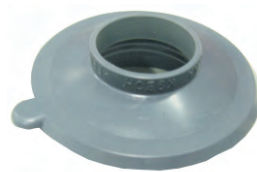

SEAL FUEL TANK
2003-2011
9W1Z 9072A
08.9072A



P/B REPAIR KIT
1998-2002
H7001
08.H7001



P/B REPAIR KIT
1992-1997
H7002
08.H7002



P/B REPAIR KIT
2003-2011
H7003
08.H7003



WATER OUTLET
1992-1994
RH-100
08.RH100



WATER OUTLET
1995-2000
RH-126
08.RH126

CROWN VICTORIA-GRAND MARQUIS-LINCOLN TOWN CAR-NAVIGATOR-EXPLORER-EXPEDITION

TRUSTTEC

CROWN VICTORIA-GRAND MARQUIS-LINCOLN TOWN CAR-NAVIGATOR-EXPLORER-EXPEDITION

TRUSTTEC



NIPPLE HEATER PIPE
1997-2011
F75Z8555AA
08.8555AA



HEATER PIPE
1998-2000
F8AZ 18B402BA
08.18B402BA



HEATER PIPE
2001-2002
1W7Z18663AA
08.18663AA



HEATER PIPE
2003 -2011
9W1Z 18663A
08.18663A



TIE ROD END
2003-2011
3W1Z 3A130BB/BA
083A130BB/BA



"O" RING
1996-2009
RG 571 FIVY 8255A
08.RG 571



STAR GASKET
F6ZZ 9L467 B
08.9L467B



PLUG W/GASKET
F75Z 6730BA
08.6730BA



GASKET T/C
1992-2009
F1AZ 6020A
08.6020A



GASKET T/C
1992-2009
F1AZ 6020B
08.6020B



GASKET T/C
1992-2009
F1AZ-6020BB
08.6020BB



GASKET T/C
1992-2009
F1AZ 6020C
08.6020-C



SEAL
F7AZ 7052A
08.7052A



BOLT
FOVY 1107A
08.1107A



NUT
6W7Z 1012BA
08.1012BA



FUEL INJECTION RING
1996-2009
CM 4717
08.CM 4717

CROWN VICTORIA-GRAND MARQUIS-LINCOLN TOWN CAR-NAVIGATOR-EXPLORER-EXPEDITION

TRUSTTEC®

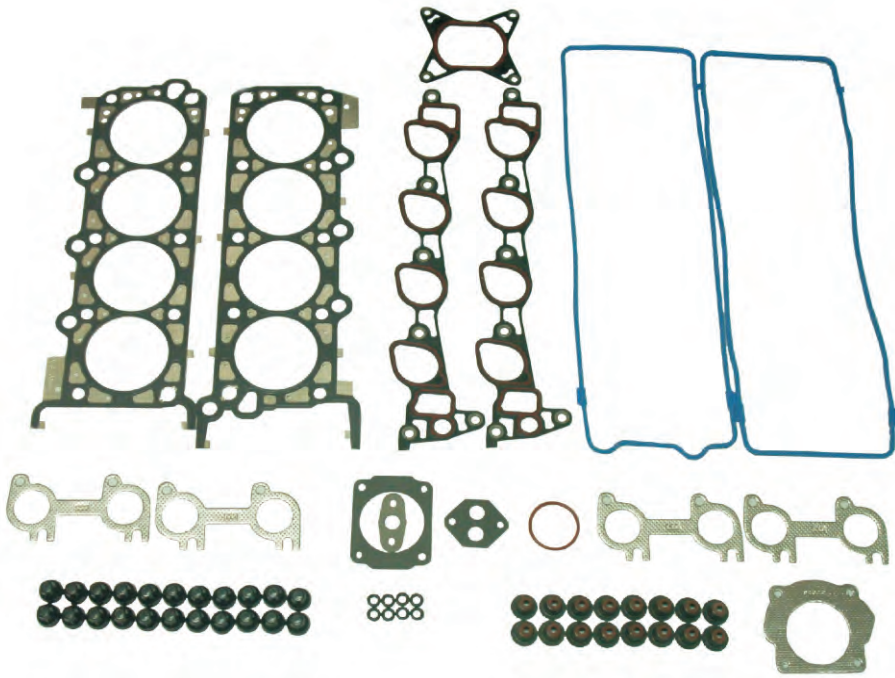

GASKET SET UPPER
2003-2009-4.6LT-ENG
3W7Z 6079AA
08.6079AA

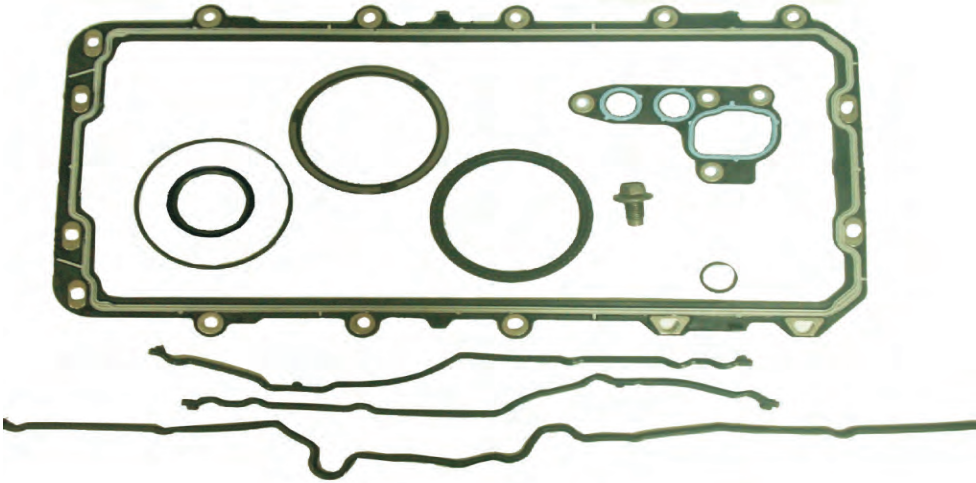

GASKET SET LOWER
1992-2011-4.6LT-ENGINE
3W7Z 6E078A
08.6E078A



NUT
6C2Z 1012AA
08.1012AA



BOLT
F5AZ 1107A
08.1107A



PISTON
H591CP
08.H591CP



BUMPER
390096-S100
08.S100



SEAL KIT
F7AZ 3E502AA
08.3E502AA



SEAL KIT
F7AZ 3E501AA
08.3E501AA



INSULATOR
F8AZ 5493AA
08.5493AA



SEAL KIT
F3AZ 3E502A
08.3E502A



SEAL KIT
D7AZ 3E501B
08.3E501B



ENGINE VALVE
I-2388/E-2421
08.-2424S



A/C SEAL KIT YE-57
F1VY-19D665-A
08.19D665-A

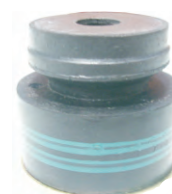

BODY MOUNT
F5VZ-5400396A
08.0396A



6W1Z 5400396B
F8VZ 5400155ZZ
08.0396B



BOLT
W709224-S439
08.S439



BOLT
W704883 SS436
08.SS436



GASKET
1L2Z 9461CA
08.9461CA

CROWN VICTORIA-GRAND MARQUIS-LINCOLN TOWN CAR-NAVIGATOR-EXPLORER-EXPEDITION

TRUSTTEC

**OVERHAUL GASKET & OIL SEAL KIT
F8AZ-7153-AC
08.F8AZ-7153-AC
CONSISTING OF.:**

CROWN VICTORIA-GRAND MARQUIS-LINCOLN TOWN CAR-NAVIGATOR-EXPLORER-EXPEDITION

TRUSTTEC®

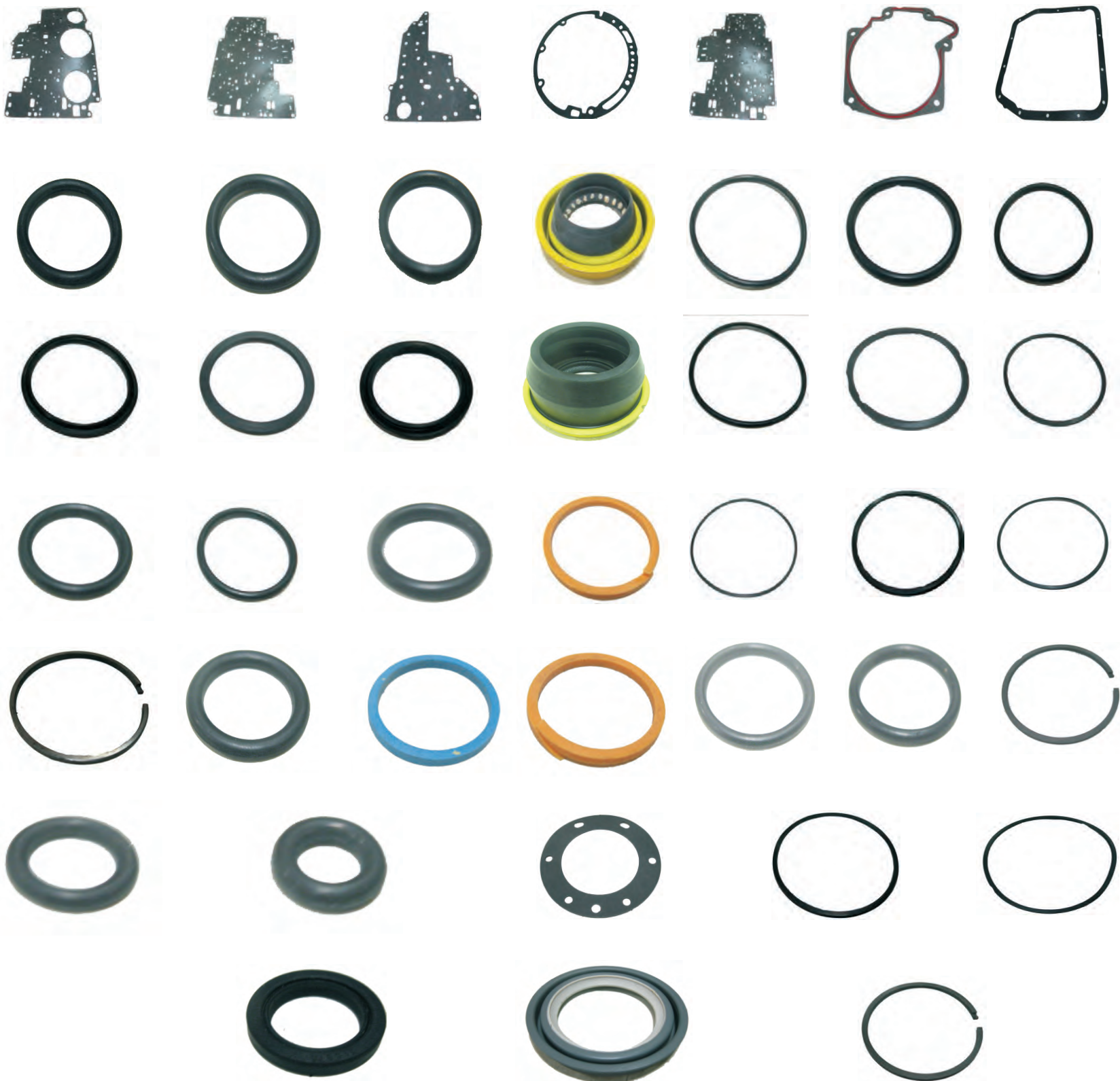

**GASKET & SEAL KIT
 DXFIOD-PRS
 AOD(FIOD)
 08.DXFIOD-PRS
 CONSISTING OF.:**

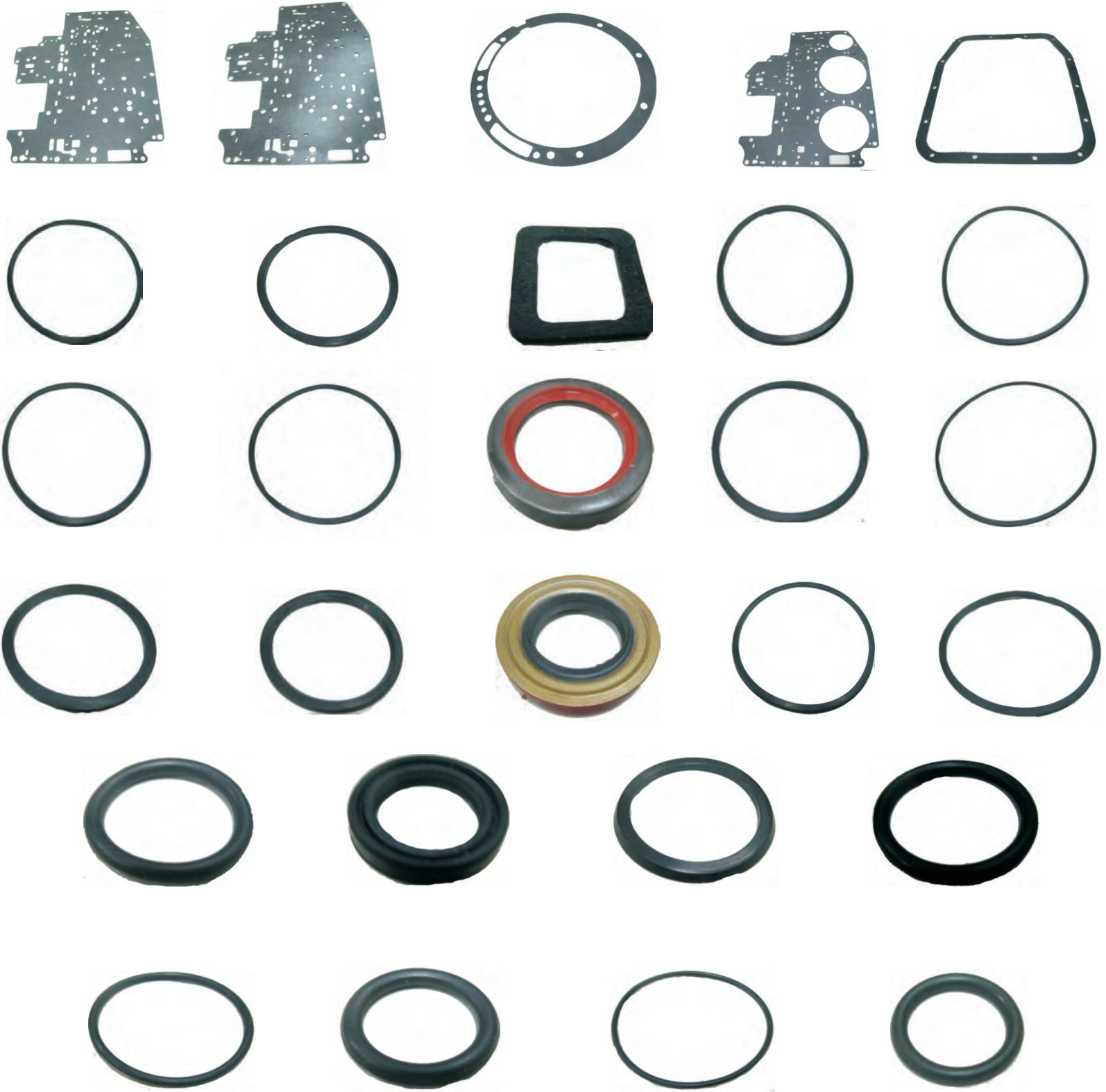

CROWN VICTORIA-GRAND MARQUIS-LINCOLN TOWN CAR-NAVIGATOR-EXPLORER-EXPEDITION

TRUSTTEC®

GASKET & SEAL KIT
1992-1995
DXAODE-PRS
AODE,AODE-W(4R70W)
08.DXAODE-PRS
CONSISTING OF.:

CROWN VICTORIA-GRAND MARQUIS-LINCOLN TOWN CAR-NAVIGATOR-EXPLORER-EXPEDITION

TRUSTTEC®

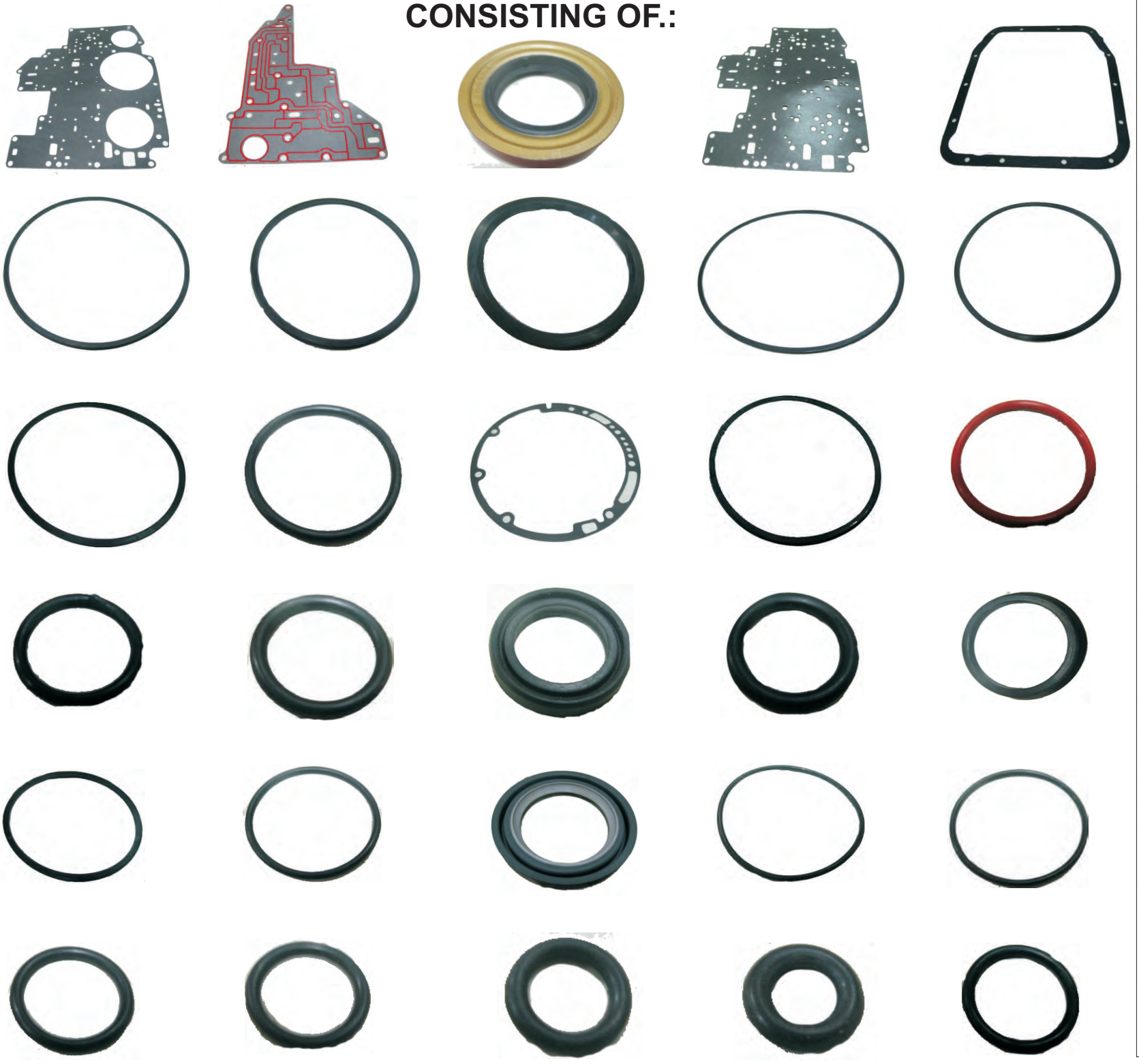

**GASKET & SEAL KIT
1996-2002
DX4R70W-PRS
AODE-W (4R70W)
08.DX4R70W-PRS
CONSISTING OF.:**

CROWN VICTORIA-GRAND MARQUIS-LINCOLN TOWN CAR-NAVIGATOR-EXPLORER-EXPEDITION

TRUSTTEC

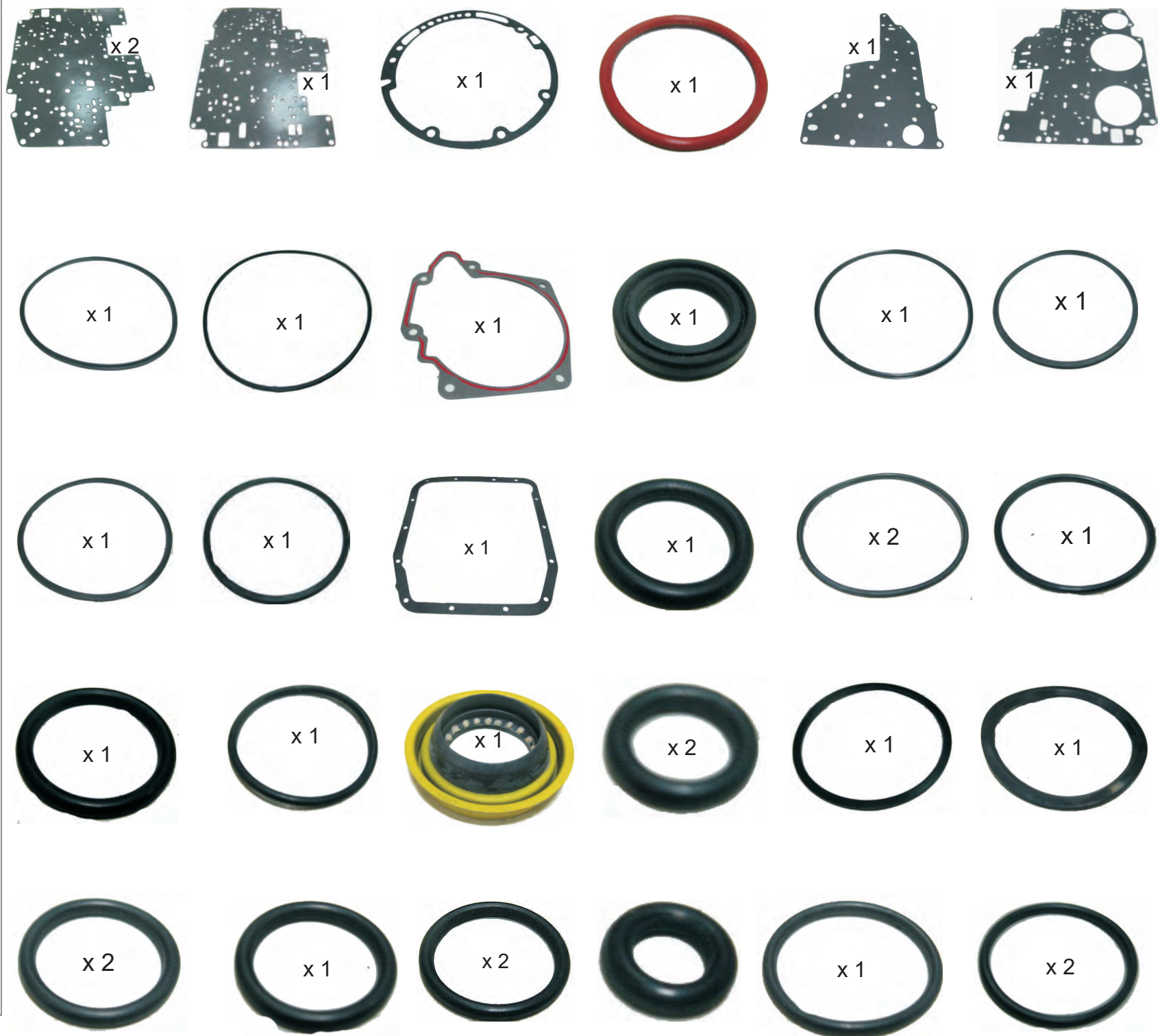



IDLER ARM
1W1Z3355AA
MEOE60
08.3355AA



PITMAN ARM
F5AZ3590A,
MCS190144
08-3590A



PITMAN ARM
4U2Z 3V590AA/
MCS 190143
08.3V59AA



WATTS LINK
K660169
3W1Z4264AA
08-4264AA



POWER STG. HOSE
2003-2010
1W7Z 3A719AA
08. 3A719AA



POWER STG. HOSE
6W1Z 3A719A
08.3A719A



POWER STG. HOSE
F5AZ 3A719A
08.3A719A



U JOINT
3W1Z6038BB
08-6038BB



GASKET,2001-2010
YL3E9441AA
08-9441



PARKING CABLE
ASSY,FRONT,CROWN
VICTORIA 98-02
2W7Z-2853-BA, BRCA-3
08-2853BA



PARKING
CABLE,REAR,MERCURY
GRAND MARQUIS,98-02
2W7Z2A635DA
08-A635DA



PARKINGCABLE,REAR,
RIGHT,FORD MERCURY
GRAND,2002
2W7Z2A635GA
08-A635GA



PARKING CABLE
ASSY,FRONT,2003 UP
3W1Z2853AA
08-2853AA



PARKING
CABLE,REAR,LEFT,03-11
4W7Z2A635AA
08-A635AA



WINDOW
REGULATOR,FRONT,
RIGHT,92-11
6W7Z5423208AA
08-3208AA



WINDOW
REGULATOR,FRONT,
LEFT,92-11
6W7Z5423209AA
08-3209AA

CROWN VICTORIA-GRAND MARQUIS-LINCOLN TOWN CAR-NAVIGATOR-EXPLORER-EXPEDITION

TRUSTTEC



WINDOW
REGULATOR,REAR,RIGHT
,BACK,CROWN
VICTORIA,2011-92
6W7Z5427008AA
08-7008AA



WINDOW
REGULATOR,REAR,
LEFT,BACK,CROWN
VICTORIA,2011-92
6W7Z5427009AA
08-7009AA



SHOCK ABSORBER,
FRONT, LH/RH
6W7Z18124B,
6W7Z18124D,ASH-12273
08-8124B



SHOCK ABSORBER
BW7218125B,
7W1Z18125G,
6W7Z18125B,
ASH-12276
08-8125B



RACK & PINION
BELLOW,LEFT,04-08,
FORD EXPEDITION
2L1Z3K661GA, K150283
08-K661GA



RACK & PINION
BELLOW,RIGHT,
04-08,FORD
EXPEDITION,03-06
2L1Z3K661HA
08-K661HA



RACK & PINION
BELLOW,RIGHT,
FORD LINCOLN
6L2Z3K661A, K150291
08-K661A



STEERING
LINKAGE,INNER,
TAURUS,10-16
DG1Z-3280A
08-280A



SWAY BAR LINK KIT
6L2Z5K483AA,
MEF 187
08-K483AA



SWAY BAR LINK KIT
REAR
6L2Z5K484AA,
MEF 139
08-K484AA



TORSION
ARM,TAURUS 13-19
DG1Z6068A
08-6068A



BALL JOINT
F2AZ 3V049AA/
MCS 10422S
08.3V049AA



BALL JOINT
F4ZZ 3V050A/
MCS104226
08.3V050A



SUSPENSION
BALL JOINT
23A634AC17L
MCSOE54,K8678
08-8678



SUSPENSION BALL
JOINT,FRONT LOWER
MCSOE190145,K8685
08-8685



SUSPENSION BALL
JOINT,LOWER
F8AZ3050AA
08-3050AA



FRONT LOWER BALL JOINT
MC SOE17/3W1Z3050A,
6W1Z3078AA/6W1Z3079AA,
6W1Z3050A
M14x1.5,L:114,W:57,H:57mm
08-3078AA



BALL JOINT
F7AZ3049AA
MC SOE 54
07-0E54



BALL JOINT,
FRONT, LOWER
9L3Z3050A/MC SOE-87
08-Z3050A



FRONT
SUSPENSION
STB BAR LINK KIT
F6AZ5K484AA
MEF181/K8853
08-8853



STB LINK
MEF171/F8AZ5K484AA
M10x1.5MM
08-K484AA



STB LINK FRONT
RIGHT/LEFT
3W1Z5K484AA,
MEF170/6W1Z5K484AA
08-484



STB BAR LINK
FRONT, RIGHT
GG1Z5K484A, MEF 352
08-K484A



STB BAR LINK, FRONT
AA525K483A
MEF 353
08-K483A



SUSPENSION
TRAILING ARM, UPPER
8W1Z55008A/RK641800
08-5008A



SUSPENSION TRAILING
ARM, LOWER
RK641799/3W1Z5A649AA
08-4649A



SUSPENSION STB
BAR BUSH
K200168, K8732
08-8732



SUSPENSION
STB BAR BUSH
4W1Z5493DA
08-5493DA



STABILIZER BAR
BUSHING, REAR
7L2Z3050A/K80771
08-3050A



FRONT UPPER
CONTROL ARM BUSHING
K8276/D9AZ3068A
08-8276



CONTROL ARM
BUSHING
K8837
08-8837



CONTROL ARM
BUSHING, FRONT, UPPER,
FORD EXPLORER, 09-09
1L2Z3084AA/K200193
08-0193

CROWN VICTORIA-GRAND MARQUIS-LINCOLN TOWN CAR-NAVIGATOR-EXPLORER-EXPEDITION

TRUSTTEC



CONTROL ARM
BUSHING,FRONT,UPPER,
FORD EXPLORERE,06-10
6L2Z3084AA/6L2Z3085AA,
K200356
08-0356



CONTROL ARM
BUSHING,FRONT,
LOWER,FORWARD,
FORD EXPLORER 2006
7L2Z7078AB/K200194
08-0784AB



CONTROL ARM
BUSHING,FRONT,
LOWER,REARWARD,
FORD EXPLORER 2006
7L2Z7079AB, K200195
08-079AB



CONTROL ARM
BUSHING,FRONT,
LOWER
F57A3069CB/K8705
08-069CB



CONTROL ARM
BUSHING,FRONT,
RIGHT,LOWER,
EXPLORER,2011-2018
BB5Z3C339A/K200779
08-C339A



CONTROL ARM
BUSHING,FRONT,
REAR,LOWER,
EXPLORER,2011-2018
BB5Z3C403A/K200778
08-C403A



CONTROL BUSH,
FRONT UPPER,FORD
EXPEDITION,06-18
7L1Z3085A/K80417
08-3085A



CONTROL ARM
BUSH,FRONT,
UPPER,07-14,FORD
EXPEDITION
9L3Z3084/K200353
08-0353



CONTROL ARM BUSHING
FRONT, REAR,LOWER
5F9Z3078BA/9G1Z3C339AK2
00363
08-078BA



CONTROL ARM
BUSHING,FRONT,
REAR,LOWER
9G1Z3C403A
08-C403A



BUSH,FRONT CONTROL
LOWER ARM
K8293
08-8293



CONTROL
ARM,RIGHT,FRONT
6L3Z3078E,
MC30E101
08-3078E



CONTROL ARM,
FRONT,LEFT, LOWER
6L1Z3079E/MC30E131
08-3079E



SUSPENSION CONTROL
ARM WITH BALL JOINT,
FRONT LEFT,LOWER
RK80394/XW1Z3079CA
08-3079CA



CONTROL ARM,
FRONT LOWER,
LEFT,CROWN
VICTORIA,03-05
3W1Z3069RH/MC30E-111
08-3069RH



CONTROL ARM,
CROWN
VICTORIA 07-22
6W7Z3079B/
MC30E-124
08-3079B



CONTROL ARM,
04-06, MERCURY GRAND
6W1Z-3085-NMCSOE-37
08-3085



CONTROL ARM,
FRONT, UPPER
6W1Z3084B/MCSOE-154
08-3084B



CONTROL ARM,
FRONT LOWER, LEFT,
CROWN VICTORIA, 03-05
3W1Z3069RH/MCSOE-111
08-3069RH



CONTROL ARM,
CROWN VICTORIA
07-22
6W7Z3079B/MCSOE-124
08-3079B



CONTROL ARM, 04-06,
MERCURY GRAND
6W1Z-3085-NMCSOE-37
08-3085



CONTROL ARM,
FRONT, UPPER
6W1Z3084B, MCSOE-154
08-3084B



CONTROL ARM
6L2Z3078AA/RK80720
08-0720



CONTROL ARM
FRONT, LOWER
6L2Z3078AA,
7L2Z3079AB
08-079AB



CONTROL ARM
FORD EXPLORER 07-10
6L2Z3084AA/MCSOE153
08-E153



CONTROL ARM,
FORD EXPLORER 07-10
6L2Z3085AA, MCSOE164
08-E164



CONTROL
ARM, FRONT, LOWER,
RH, TAURUS
FA5Z3078A
08-3078A



CONTROL ARM
BRACKET, FRONT,
LOWER
FA5Z3079A
08-3079A



CONTROL ARM
FRONT, LOWER
8T4Z3079A/MCSOE126
08-0E126



CONTROL ARM,
FRONT, LOWER
8T4Z3078A, MCSOE95
08-0E95



TIE ROD END
F5AZ 3V130A
08.3V130A



TIE ROD END
INNER, RIGHT
F5AZ3V131A,
MES2056R
08.3V131A



TIE ROD END,
FRONT,RIGHT,OUTER,
FORD,LH,2006 UP
3W1Z-3A130-BA/ES3694,
MEOE72
08-A130BA



TIE ROD END
9G1Z-3A130-A,
MEOE 112
08-A130A



TIE ROD END
EXPLORER,07-10
AL2Z3A130A
MEOE222
08-A130A



TIE ROD END
FRONT,INNER,
FORD,2003 UP
8W7Z3280A/EV455
MEOE174
08-3280A



TIE ROD ADJ
SLEEVE,FORD 98
UPEV455
F5AZ-3310A/ES3311S
08-3310A



TIE ROD END
INNER,EXPLORER
6L2Z3280A,EV800278
08-0278



TIE ROD BOOT
FORD,2003
3W1Z3K661AA
08-K661AA



ENGINE FRONT SUPPORT
BRACKET,07-14
DG1Z6038C/8T4Z6038A
8G4Z6038A/8G1ZC6038A
08-Z6038C



MOUNTING BRACKET
8W7Z-18183-A
AD 1059
08-1059



ENGINE
MOUNTING,RIGHT,
FORD,2003-2011
3W1Z6038BB
08-6038BB



ENGINE MOUNTING
LEFT,FORD,2003-2011
3W1Z6038BA
08-0388A



STRUT MOUNT
FRONT RH/LH,
09-20
7L1Z18A099E
08-A099E



STRUT MOUNT
UPPER,REAR,
EXPEDITION 07-23
7L1Z18A099C
08-A099C



STRUT MOUNT,UPPER,
2013-2019
FB5Z18183A
DG1Z-18183-B,
08-8183B



STRUT MOUNT
FRONT UPPER
6L2Z-18183-B/AD-1043
08-1043



STRUT MOUNT
FRONT,UPPER
8A8Z18183A,
AD1066
08-8183A



STRUT MOUNT,FRONT,
UPPER
FB5Z18183A
AD1147
08-1147



TRANSMISSION
MOUNT,
LEFT,UPPER
DG1Z6038D
08-6038D



MOTOR MOUNT,FORD
7A2Z-6038D/BL2Z-6038AB
6L2Z-6038AB/5L2Z-6038-BB
5L2Z-6038-BD/7A2Z-6038-B
5L2Z-6038-AD
08-6038D



MOTOR
MOUNT,FORD
7A2Z-6038CA
08-6038CA



54101-4HA00
WVA 24597
W:164.5,H:63.4,Thk:17.6mm
TBP-HHA00



58101-1GE00
W:56,Thk:17mm
WVA 24317/24318/24319
TBP-HGE00



58101-4AA90
L:149,w:58,Thk:17mm
WVA 23569/23570/23571
TBP-HAA90



58101-D4A00
TBP-H4A00



58101-1MA00
L:130/W:17.5mm
TBP-HMA00



58101-1RA00
TBP-HRA00



58101-2HA10
L:131.6/W:59.9/Thk:16.9
TBP-HHA10



58101-2PA70
l:157/w:62/thk:16MM
TBP-HPA70



58101-2TA00
TBP-HTA00



58101-34A21
L:137/W:54/THK:54mm
TBP-H4A21



58302-1RA30
L:99.8/W:41/THK:14.3mm
TBP-HRA30



58302-3KA62
TBP-KA62



58302-2SA70
L:93.1,W:41,THK:15mm
TBP-H5A70



58302-2HA00
L:98.8,W:40.7,THK:14.8mm
TBP-HHA00



58302-2PA70
L:116.8,W:48.3,THK:14.4
TBP-HPA70



58101-2DA31
L:137,W:63.5,
THK:16.8mm
TBP-HDA31



58101-4EB00
L:193,W:70,THK:17.5mm
TBP-HEB00



58101-24B00
L:127.5,W:49mm,Thk:14.5mm
TBP-H4B00



58302-2SA30
L:93,W:47,THK:15.6mm
TBP-HSA30



58101-2SA30
L:130,W:56.8,
THK:16.8mm
TBP-H2SA30



58305-1GA00
W:32,OD:203.2,THK:4MM
TBS-HGA00



58305-2HA10
W:41,INSIDE DIA:190mm
TBS-HHA10



58305-2HA00
W:39,D:203mm
TBS-HHA00



58305-3SA30
SHOE & LINING KIT
D:167,W:24mm
TBS-HSA30



58305-2SA10
BRAKE SHOE
TBS-HSA10



58305-2DA10 / 58305-28A00 / 58305-28A60
58305-28A70 / 58305-28B00 / 58305-28C00
58305-28D00 / 58305-28E00/ 58305-29A00
58305-29A10
TBS-HDA10



58350-1MA00
TBS-HMA00

CROWN VICTORIA-GRAND MARQUIS-LINCOLN TOWN CAR-NAVIGATOR-EXPLORER-EXPEDITION

TRUSTTEC®

TRUSTTEC®

www.trusttec.eu



Steel Impex & Industries

*Survey No. 115, Hissa No. 6, Ghodbunder Village Road,
Mira Road (E), Thane - 401 107, Maharashtra-India.,
Mob: +91 9820086421 / +91 9820239477
+91 8928687137, Email: info@steelimpex.net
trusttec@trusttec.eu / sales@foxbearings.eu*

*Eppendorfer Landstrasse 33,
20249 Hamburg,
Germany*

 **ISO 9001:2015**
IATF 16949:2016