

FOX[®]

B E A R I N G S

www.foxbearings.eu

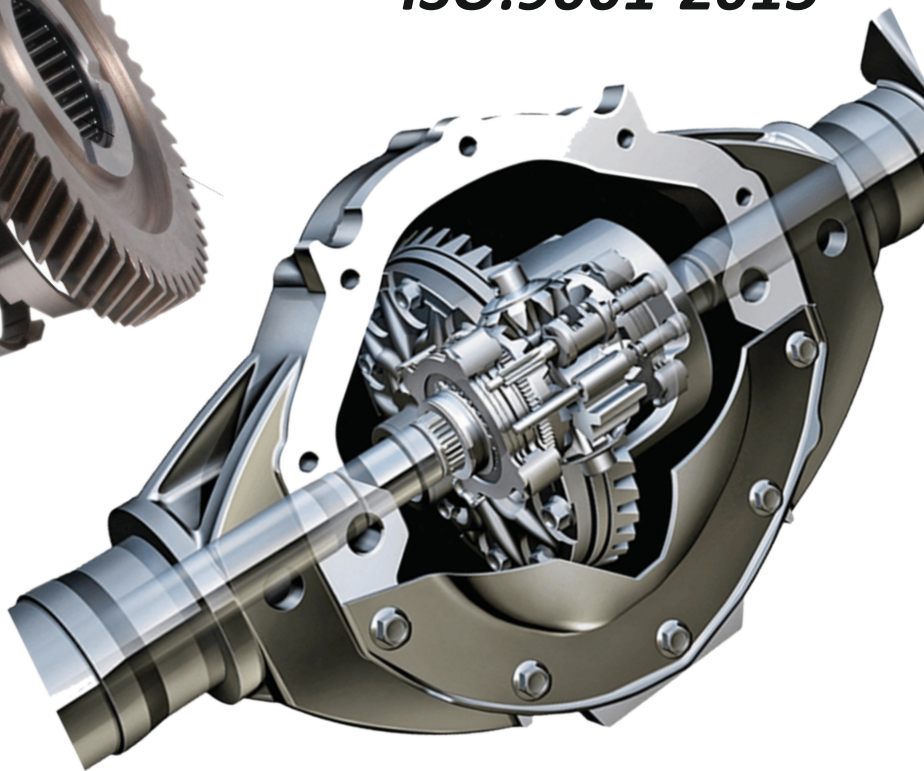
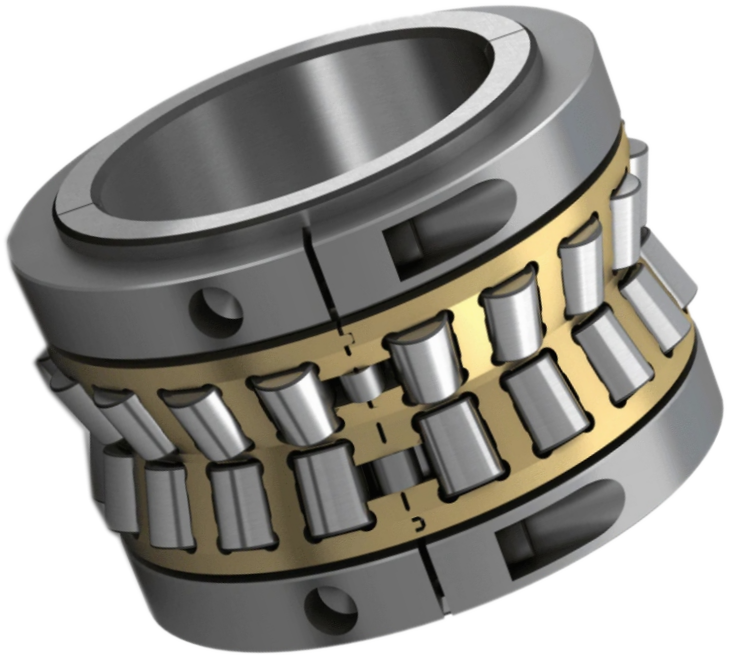

Customer:
OEM,s
Tier1 & Tier 2
Aftermarket
ISO:9001-2015

TRUSTTEC[®]

www.trusttec.eu

TRUSTTEC[®]

TRUSTTEC[®] is one of the largest full-range suppliers of spare parts for Commercial Vehicles, Passenger Cars and Tractors.

The brand, which was established in 2006, is backed by experience of over 6 decades in the automotive spare parts industry.

Due to our relentless dedication to quality, we have seen continuous growth of the brand ever since its launch

Currently the brand is selling very successfully in Germany, Saudi Arabia, Iran, Egypt, Tanzania, UAE, Sri Lanka, Iraq, Serbia, Slovenia, Croatia, Brazil, Chile, Jordan, Syria, Turkey, Kenya, Yemen, Libya, Botswana, Nigeria, South Africa and USA. **TRUSTTEC**[®] will be made available in more markets in the Middle East, Africa, Australia, Europe and North and South America in the near future.

TRUSTTEC[®] offers a huge range of parts developed for Commercial Vehicles especially Mercedes, Scania, Volvo, as well as Tractors like Massey Ferguson, IMR/IMT, Romania and for Toyota, GM & Ford Cars/SUV's. Similar efforts are being undertaken to develop a range of MAN, DAF & Eaton spares.

We are dedicated to providing high quality products and defect free shipments. We strive to maintain high quality standards right from development stage, through the entire production process and finally to the most important part of packaging and presentation.

The **Quality Systems** that we follow are “*quality assurance*” which is the prevention of defects, by the deployment of a quality management system and preventative activities. The other is “*quality control*” which is the detection of defects, most commonly associated with testing which takes place within our quality management system involving verification and validation.

We believe that quality is accomplished by better management of design, engineering, testing and by improvement of processes.

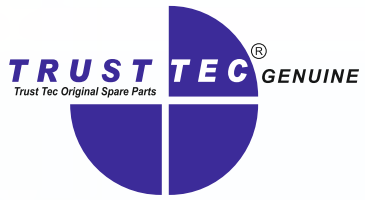

QUALITÄT ERSATZTEILE

TRUSTTEC® has now developed an extensive range of **BPW** spares.



TRUSTTEC®



Spherical Roller Bearings
Thrust Spherical Roller Bearings
Multi Row & Angular Contact Bearings
GE Series
Single Row Cylindrical Bearings
Tapper Roller Bearings



FOX[®]



Hub Bearing Units:



FOX[®]



QUALITÄT ERSATZTEILE

TRUSTTEC® has developed entire range of transmission gears of gearboxes from Old Generation to new Aluminium Gearboxes.

Mercedes Gear Boxes

- | | | | |
|-------------------|--------------------|-----------------------|------------------|
| G 2/24 - 5/6.71 | G 2/24 - 5/7.31 | G 3/36 - 5/8.98 | G 3/36 - 5/7.508 |
| G 3/50 - 5/8.5 | G 3/60 - 5/6.1 | GO 3/60 - 5/6.1 - 1.0 | G 3/60 - 5/75 |
| 6 3/61 - 5/6.1 | G 3/65 - 8/9.29 GP | G 3/70 - 4/4.24 | GO 4/160 - 6/8.2 |
| | - 9/13.36 GP | | |
| GO 4/160 - 6/7.18 | G 4/65 - 6/9.0 | | |

8 Speeds

GO 210

9 Speeds

G 131 G 155 G221

12 Speeds

G 100 G 211

16 Speeds

G 125	G 135	G 155	G 180
G 200	G 210	G 211	G 231
G 240	G 260		

All types of Gears, for example Spur Gears, Helical Gears, Epicyclic Gears, Sun and Planetary Gears as well as Synchronizer Rings, Hubs and Sleeves have been developed by us as well as range of Shafts like, Input Shaft, Counter Shaft and Output shafts.



TRUSTTEC®

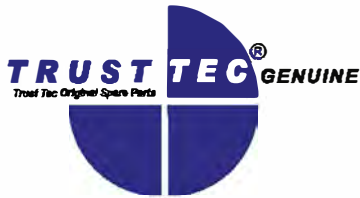

QUALITÄT ERSATZTEILE

TRUSTTEC® has developed an extensive range of Mercedes engine parts.

We have developed most types of Cylinder Heads as well as associated items such as Cylinder Liners, Pistons, Piston Rings, Connecting Rods and Bushes, Engine Valves, Guides, Seats and Cylinder Head Gaskets.

Moving Parts such as Crankshafts and Crankshafts Gears and Bushes have been developed.

Engine Timing spares such as Cam Shafts, Cam Shaft Gears and Bushes, Tappets and Rockers are available.

We are always striving to increase the variety of items on offer and are confident of developing a similar range for other vehicles as well.



TRUSTTEC®

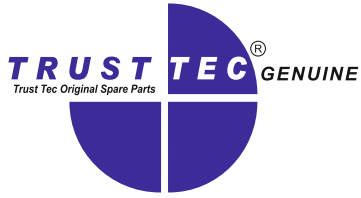

QUALITAT ERSATZTEILE

TRUSTTEC® has now developed an extensive range of **MERCEDES** Truck and Bus parts.



TRUSTTEC®

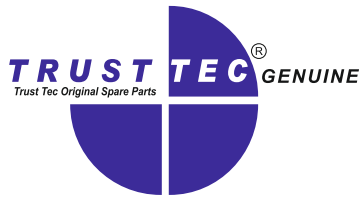

QUALITÄT ERSATZTEILE

TRUSTTEC® has now developed an extensive range of **SCANIA** Truck and Bus parts.



TRUSTTEC®

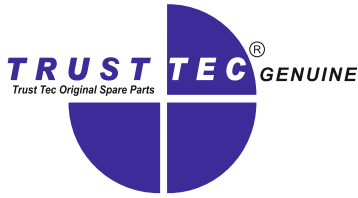

QUALITAT ERSATZTEILE

TRUSTTEC® has now developed an extensive range of **SCANIA** Truck parts. A large variety of parts for the following Gear Boxes are available:

Scania Gear Boxes

G - 770	G - 776	G - 777	GR/GRE - 860 - 870 - 871
GR/GRH - 880	GR - 801 - 900	GRS - 890 - 900 - 920	GR - 875 - 905 R
GRS/GRSO - 895 - 905 R	GR/GRS - 900		

A large range of parts from popular Differential Models have also been developed:

Scania Differentials

R 640	R 641	R 642	RP 651
R 652 (FRONT SET)	R 652/653 (REAR SET)	R 750/751/752	R 770 1 ST MODEL
R 770 2 ND MODEL	RBP 830/831/832		

Further development is ongoing and spares for a larger variety of Gear Boxes and Differentials shall soon be available.



TRUSTTEC®

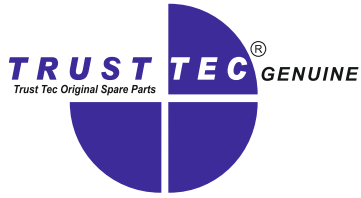

QUALITÄT ERSATZTEILE

TRUSTTEC® has now developed an extensive range of VOLVO Truck and Bus parts.



TRUSTTEC®

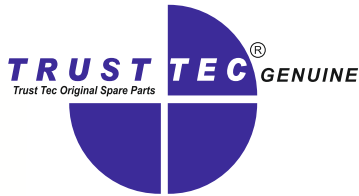

QUALITAT ERSATZTEILE

TRUSTTEC® has developed entire range of transmission gears of gearboxes from Old Generation to new Aluminium Gearboxes. Spares for the following Gear Boxes are developed/under development:

ZF Gear Boxes

5 S - 820	6 S - 65	6 S - 66 + GV 66	6 S - 80 + GV 80
AK 6 - 80	6 S - 80	GV 80	6 S - 85
6 S - 90 + GV 90	AK 6 - 90	6 S - 90	6 S - 90/6.98 - 1.0
GV 90	AK 6 - 80/90	6 S - 80/90	6 S - 150 C
6 S - 820	6 S - 1550	6 S - 1600	5 K - 110 GP
5 S - 110 GP/GPA	GV - 110	GP - 110	5 S - 111 GP
GP - 111	5 S - 111 GP/GPA	5 S - 111 GP	5 KS - 90 GP
5 K/S - 90 GPA	5 K - 91 GPA	5 K/S - 90 GP	5 S - 92 GP
GV 90/1	5 S - 92 GP	5 S 90 GP/GPA	4 S - 90
8 S - 109	8 S - 140	8 S - 180	9 S - 75
9 S - 109	16 S - 109	16 S - 150	16 S - 151
16 S - 181	16 S - 220	16 S - 220 A	16 S - 221

ZF Ecosplit I

16 S - 112	16 S - 130	16 S - 160	16 S - 190
16 S - 190 A	16 S - 112	16 K - 190	
	16 K - 160		

ZF Ecosplit II

16 S - 150	16 S - 220	16 S - 220 A
------------	------------	--------------

ZF Ecosplit III

16 S - 150	16 S - 220	16 S - 220 A	16 S - 190
16 S - 151	16 K - 2230	16 S - 220	16 S - 251

All types of Gears, for example Spur Gears, Helical Gears, Epicyclic Gears, Sun and Planetary Gears as well as Synchronizer Rings, Hubs and Sleeves have been developed by us as well as range of Shafts like, Input Shaft, Counter Shaft and Output shafts.



TRUSTTEC®



QUALITÄT ERSATZTEILE

TRUSTTEC® develops Air Compressor Kits comprising of Cylinder Blocks, Pistons with Pin and Rings, for both Air Cooled and Water Cooled Type Compressors and for all Mercedes Models.

Bore Dia of 68mm, 70mm, 77mm, 88mm, 90mm, 94mm & 100mm are in range.

Cylinder Block made from G-4000 Grade & Hardness between 190-220 BHN is maintained. Blocks are honed to achieve Plateau Finish.

Pistons are manufactured in State of the Art Manufacturing Facility thus achieving Complex 00 Profiles.

Piston Rings are manufactured from High Quality Cast Iron & Steel materials. Facilities for Surface treatments or coatings like Granoliting, Chrome Plating, Molybdenum and Flame Sprayed Coatings are available.



TRUSTTEC®



QUALITÄT ERSATZTEILE

TRUSTTEC® has developed a wide variety of spares for Intermediate and Rear Axles like Washer sets, Grooved Nuts, Flanges, Drive Shafts and in certain cases Crown Cage has also been developed.

Parts for Intermediate and Rear Axles with Ring diameter of 233 mm, 244 mm, 300 mm, 312 mm and 368 mm are available. We are constantly developing and adding more sizes.

Similar items can be developed for any other vehicle against samples.



TRUSTTEC®

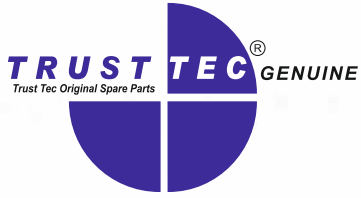

QUALITÄT ERSATZTEILE

We at **TRUSTTEC**® pride ourselves at being able to provide a massive range of spares.



TRUSTTEC®

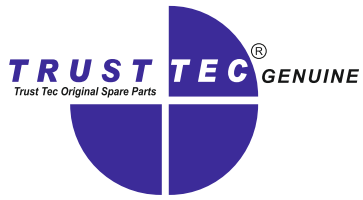

QUALITÄT ERSATZTEILE

TRUSTTEC® offers world class technology for engine coolant solutions.

Coolant Pipes
Oil Filler Pipes
Suction Pipes



TRUSTTEC®

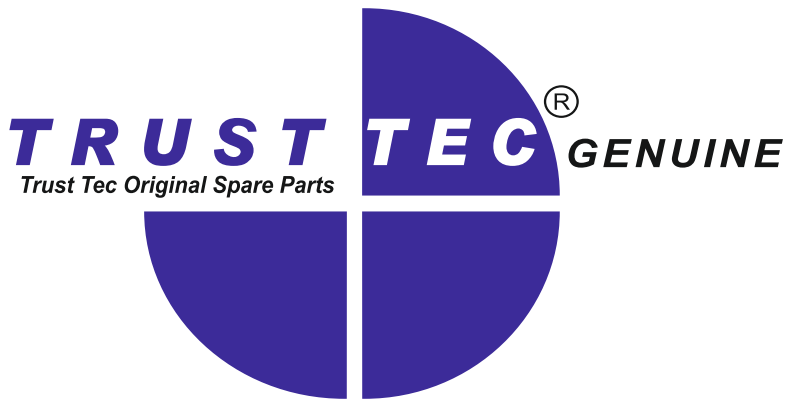

QUALITAT ERSATZTEILE

Satisfaction
Express Reward Systems Ideas Knowledge
Creativity
Technology Vision
Education
People
Share Team Concern
Plan
Practice Create
Quality Commitments
Service Sharp
Perfection Culture
Attitude Empowerment Accuracy
Sincerity
Reliability Opinions Safety
Measure Assurity
Process
Speed
Positive Cost

FOX[®]
B E A R I N G S

S&I *Steel Impex & Industries*

Survey No. 115, Hissa No.6 Ghodbunder Village Road,
Mira Road (East), Thane - 401107, India.

Office Tele :- +91 8928093906 / +91 8928687137

Sunil Batra : +91 9820086421 / Diven Batra: +91 9820239477

Email:- trusttec@trusttec.eu / info@steelimpex.net / sales@foxbearings.eu

Web:- www.trusttec.eu / www.foxbearings.eu

Eppendorfer Landstrasse 33,

20249 Hamburg, Germany.

Web: www.trusttec.eu / www.foxbearings.eu



9001:2015