



CATALOGUE 2018

DAF IVECO MAN MERCEDES RENAULT SCANIA VOLVO

CERTIFICATE



**ISO/TS 16949
: 2009**
(with product design)

TRUSTTEC[®]



TRUSTTEC[®] GASKETS ARE MADE FROM VARIETY OF RAW MATERIALS LIKE RUBBER , SILICONE, PAPER GASKETS, FIBER GLASS, PLASTIC POLYMER , CORK,FELT,METAL , GRAPHITE ETC.

C O N T E N T S

PARTICULARS	PAGE NOS.
DAF	
CYLINDER HEAD GASKET	01
HEAD GASKET SET	01
IVECO	
CYLINDER HEAD GASKET	01
MAN	
CYLINDER HEAD GASKET	02
HEAD GASKET SET	03
OVERHAUL GASKET SET	04 - 06
MAN - TGA	
CYLINDER HEAD GASKET	02 - 03
HEAD GASKET SET	03
MERCEDES	
CYLINDER HEAD GASKET	07 - 10
EXHAUST MANIFOLD GASKET	11 - 12
EXHAUST PIPE GASKET	13
INTAKE MANIFOLD GASKET	14
VALVE COVER GASKET	15 - 16
HEAD GASKET SET	17
OVERHAUL GASKET SET	18 - 41
RENAULT	
CYLINDER HEAD GASKET	42 - 44
HEAD GASKET SET	42
SCANIA	
CYLINDER HEAD GASKET	45 - 46
HEAD GASKET SET	47 - 48
OVERHAUL GASKET SET	49 - 56
VOLVO	
CYLINDER HEAD GASKET	57 - 60
HEAD GASKET SET	61 - 64
BOTTOM GASKET SET	65 - 68
OVERHAUL GASKET SET	72 - 76
DECARBONIZING KIT	77 - 78
EXHAUST MANIFOLD	79 - 80
INTAKE MANIFOLD	81
MANIFOLD GASKET KIT	82 - 83
VALVE COVER GASKET	84 - 85
WATER SEAL	85

* OEM Part Numbers & other manufacturers Part Numbers have been used in this catalog for reference & information purpose only, & are not intended to infer that our replacement parts are used on original equipment.

Suitable for

Cylinder Head Gasket

DAF

TRUSTTEC NO. 035.01.0801

OEM NO.
1320372/1366063-4
1283752/0376729
1298923

OTHER NO.
61-27205-10,
760.082,
BW 470,
300 265 90 10

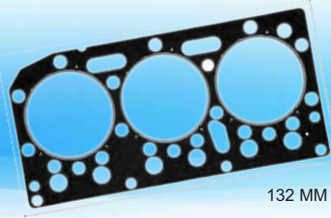

132 MM

APPLICATION	CYLINDER	CAPACITY	YEAR
F 95 XF 380, 430, 4806	11600	1997 ON	
WS 1160/225/242/ 259/268/268L/282/ 295L/315L			

Head Set Gasket

DAF

TRUSTTEC NO. 035.01.0802

OEM NO.
0682680,0683336

OTHER NO.
02-27205-02,
917.209

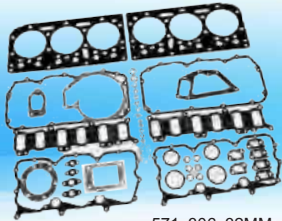

571x306x32MM

APPLICATION	CYLINDER	CAPACITY	YEAR
F 95 XF 380, 430, 4806	11600	1987 ON	
WS 1160/225/242/259/ 268/268L/282/295L/ 315L			

Cylinder Head Gasket

IVECO

TRUSTTEC NO. 036.01.0801

OEM NO.
61319085/61316613
61316613

OTHER NO.
61-33970-00,
776.395,
BS 350

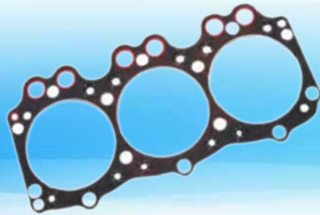

APPLICATION	CYLINDER	CAPACITY	YEAR
Eurostar, Eurotech, Euro Trakker, Turbotech, M175-24 T	6	9500	1989 ON

Suitable for

Cylinder Head Gasket

MAN

TRUSTTEC NO. 022.01.0801

OEM NO.
51039010342/51039010262
51039010268/51039010281
51039010268/51039010281
51039010252/51039010216
51039010244/51039010246
51039010227/51039010233
51039010245

OTHER NO.
61-25110-60,
834.548



125MM

APPLICATION	CYLINDER	YEAR
D 2555, D 2565	5	1972 ON
D 2556, D 2566	6	1972 ON
D 2538	8	1973 ON
D 2530, D 2540	10	1971 ON
D 2542	12	

TRUSTTEC NO. 022.01.0802

OEM NO.
51039010356/51039010015
510390338/10139100
51039010298
442 016 0520/442 016 0320
442 016 0520/442 016 0020
442 016 0320/442 016 0020

OTHER NO.
61-25275-00,
451.690

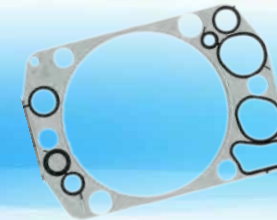

220.5x157.5x143.5x1.13MM

APPLICATION	CYLINDER	YEAR
D 2865	5	
D 2866, D 2876	6	
D 2848	8	1976 ON
D 2840	10	1978 ON
D 2842	12	1976 ON

TRUSTTEC NO. 022.01.0803

OEM NO.
51039010268/51039010342
51039010262/51039010281
51039010252/51039010216
51039010244/51039010246
51039010227/51039010233
51039010245

OTHER NO.
61-25110-50

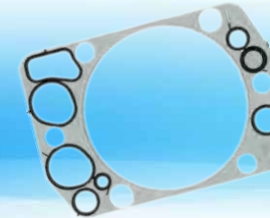

APPLICATION	CYLINDER	YEAR
D 2555, D 2565	5	
D 2556, D 2566	6	1974-1994
D 2538	8	
D 2530	10	1971 ON
D 2542	12	

Cylinder Head Gasket

MAN TGA

TRUSTTEC NO. 022.01.0804

OEM NO.
51039010338/51039010366
51039010015/51039010356
10139100

OTHER NO.
829.722



218x184x2mm

APPLICATION	CYLINDER	YEAR
D 2840, D 2530	10	15945
D 2540		
D 2538, D 2848	8	12763
D 2540	10	17426
D 2542, D 2842	12	20911
D 2840	10	18273
D 2842	12	21927
D 2848	8	14618
D 2865	5	9973
D 2866, D 2876	6	11967
D 2876	6	12816

Suitable for

Cylinder Head Gasket

MAN TGA

TRUSTTEC NO. 022.01.0805

OEM NO.

51039010382/51039010338
51039010366/51039010015
51039010356/10139100

OTHER NO.

099.980
61-35145-00



APPLICATION	CYLINDER	YEAR
MAN D 2866 / D 2876		
MAN E 2000		05/00
MAN F 2000		06/98
MAN TG-A 18/24/26/ 33/35/37/40		09/02
SCANIA 4 - series T 94/G 260		12/96

Head Set Gasket

MAN

TRUSTTEC NO. 022.01.0806

OEM NO.

51009006570/51009006437
51009006231/51009006266
51009006273/51009006280
51009006349/51009006438
51009006445/51009006448
51009006230/51009006271
51009006443

OTHER NO.

03-25110-01,
286.711



APPLICATION	CYLINDER	YEAR
D 2555, D 2565	5	1971 ON
D 2556, D 2566	6	1972 ON
D 2538	8	1973 ON
D 2530	10	1971 ON
D 2542	12	

MAN

TRUSTTEC NO. 022.01.0807

OEM NO.

51009006558/51009006536
51009006552

OTHER NO.

03-25275-03



APPLICATION	CYLINDER	YEAR
D 2865	5	
D 2866, D 2876	6	
D 2848	8	1979 ON
D 2840	10	1978 ON
D 2842	12	1976 ON

MAN TGA

TRUSTTEC NO. 022.01.0808

OEM NO.

51.00900.6630

OTHER NO.

296.770



APPLICATION	CYLINDER	YEAR
D 2866, D 2876	6	11967

Suitable for

Cylinder Head Gasket

MAN TGA

TRUSTTEC NO. 022.01.0809

OEM NO.

51009006398

OTHER NO.

01-25275-07,
518.346, 518.347

APPLICATION

D 2866,
LH01/02, KH/KFZ/KOH,
LFZ/LFZR, KF, LF02-10/14-17,
TOH, OH, LFG / LXFG, LXF

CYLINDER

6

CAPACITY

11967

YEAR

1986-96



MAN

TRUSTTEC NO. 22.01.0810

OEM NO.	APPLICATION	CYLINDER	CAPACITY	YEAR
51009006471	D2566 MK / MKF / MKH / MK	6	11413	1979 ON
OTHER NO. 891.232				

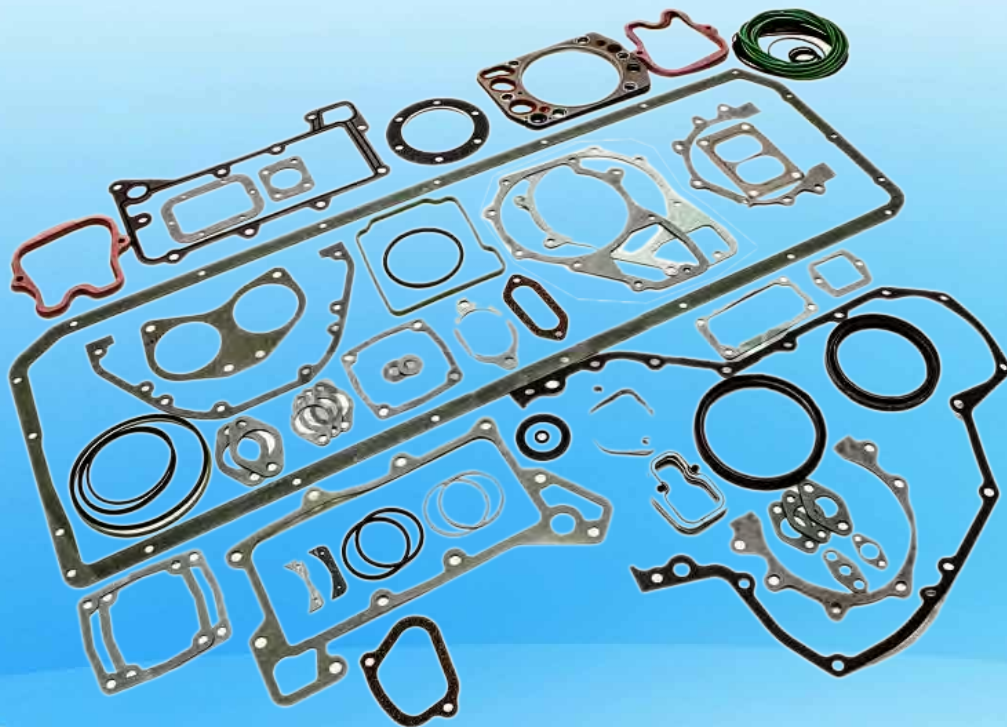

WASHER & O-RING DETAILS-ORDER BY SIZE		
Description	Qty.	
G4-4129/1 SILICON RUB LIGH T GREEN	1	
G4-3527 NIGHT RUB BLACK	1	
G4-3528 NIGHT RUB BLACK	1	
G4-3529 NIGHT RUB BLACK	1	
G4-3530 NIGHT RUB BLACK	2	
G4-2946/5 NIGHT RUB BLACK COLOR	2	
G4-3531 NIGHT RUB BLACK COLOR	3	
G4-3532 NIGHT RUB BLACK COLOR	1	
G4-3533 SILICON RUB LIGHT GREEN	1	
G4-4013/1 VITON RUB LIGHT GREEN	12	
G4-4013/2 VITON RUB LIGHT GREEN	12	

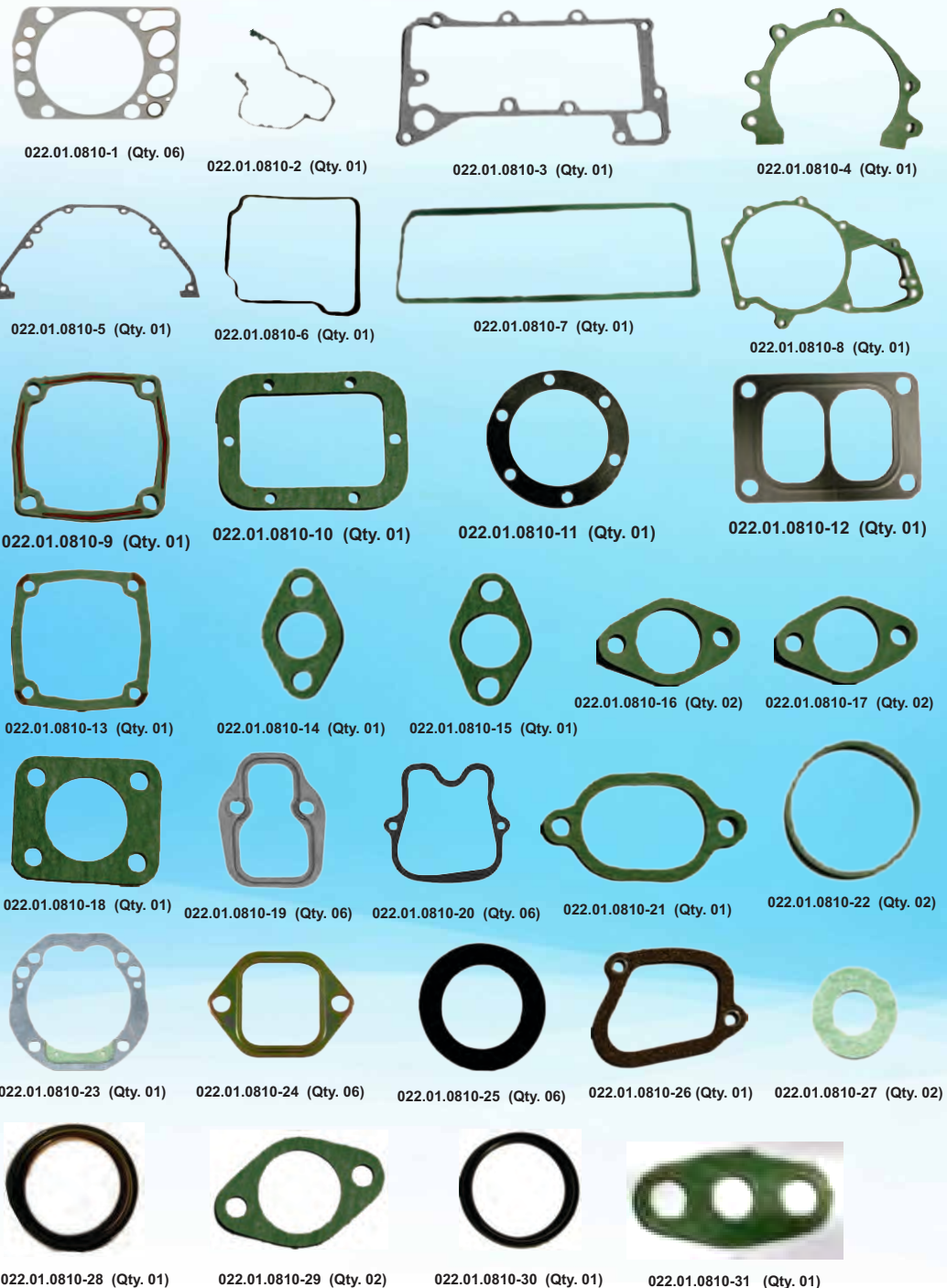

Suitable for

Cylinder Head Gasket

MERCEDES

TRUSTTEC NO. 01.01.0901

OEM NO.

314 016 07 20

OTHER NO.

089.176

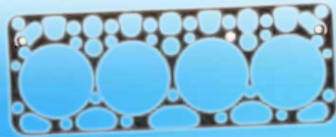

APPLICATION	CYLINDER	CAPACITY	YEAR
OM 314	4	3784	1965 ON

TRUSTTEC NO. 01.01.0902

OEM NO.

346 016 03 20

OTHER NO.

173.968



APPLICATION	CYLINDER	CAPACITY	YEAR
Om 346 MB 346.910-918 MB 346.941-946 MB 346.952-953	6	10809	1961 ON

TRUSTTEC NO. 01.01.0903

OEM NO.

352 016 06 20
352 016 07 20

OTHER NO.

089-184,
AS 410

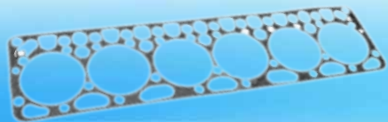

APPLICATION	CYLINDER	CAPACITY	YEAR
OM 322, OM 352 OM 353, OM 363 OM 366	6	5675	1964 ON

TRUSTTEC NO. 01.01.0904

OEM NO.

355 016 04 20

OTHER NO.

749.541



APPLICATION	CYLINDER	CAPACITY	YEAR
OM 346, OM 355	6	11580	1967 ON

Suitable for

Cylinder Head Gasket

MERCEDES

TRUSTTEC NO. 01.01.0905

OEM NO.

460 016 04 20

OTHER NO.

61-37770-00,
462.202



APPLICATION	CYLINDER	CAPACITY	YEAR
OM 457 LA/ OM 457.937 OM 460	6	11967	01.02-10.04
MERCEDES AXOR / AXOR 2			

TRUSTTEC NO. 01.01.0906

OEM NO.

541 016 06 20
541 016 09 20

OTHER NO.

61-34190-00,
862.562



APPLICATION	CYLINDER	CAPACITY
OM 541, OM 521,	6	11946
OM 542, OM 522,	8	15928
MERCEDES ACTROS		

TRUSTTEC NO. 01.01.0907

OEM NO.

541 016 13 20

OTHER NO.

61-37190-00
066.720



APPLICATION	CYLINDER	CAPACITY	YEAR
MERCEDES ACTROS MP 2 / MP 3			04/03

TRUSTTEC NO.01.01.0908

OEM NO.

904 016 13 20

OTHER NO.

61-36110-00,
082.723, 082.724



APPLICATION	CYLINDER	CAPACITY	YEAR
Om 904, OM 904 LA,	4	4250	
ATEGO ATEGO 2 LK/LN2 VARIO 615/618/812/813	4		01/98-10/04 10/04 96/98 09/96

Suitable for

Cylinder Head Gasket

MERCEDES

TRUSTTEC NO. 01.01.0909

OEM NO.

422 016 02 20
422 016 04 20
422 016 06 20
476 016 70 20

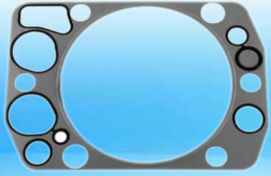

APPLICATION	CYLINDER
OM 401, OM 407, OM 421, OM 427	6
OM 402, OM 422, OM 440	8
OM 403, OM 423	10

OTHER NO.

61-25105-55,
748.080

TRUSTTEC NO. 01.01.0910

OEM NO.

366 016 06 20

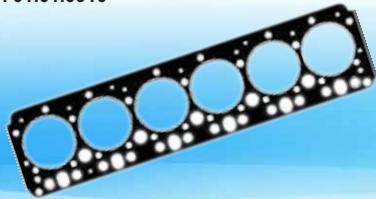

APPLICATION	CYLINDER	YEAR
OM 352, OM 353, OM 356, OM 357, OM 362, OM 366, OM 382	6	1984 ON

OTHER NO.

61-27350-40,
760.678

TRUSTTEC NO. 01.01.0911

OEM NO.

442 016 00 20
442 016 03 20

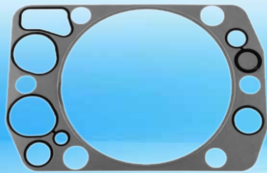

APPLICATION	CYLINDER
OM 401, OM 407, OM 421, OM 427, OM 441, OM 445, OM 447	6
OM 402, OM 422, OM 440, OM 442 OM 403, OM 423, OM 443	8

OTHER NO.

896.510,
BG 850

TRUSTTEC NO. 01.01.0912

OEM NO.

457 016 11 20

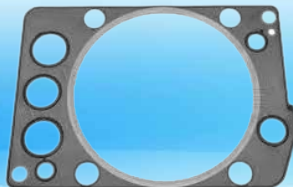

APPLICATION	CYLINDER	CAPACITY	YEAR
Om 457	6	11967	2001/02 ON

OTHER NO.

61-34285-00,
021.311

Suitable for

Cylinder Head Gasket

MERCEDES

TRUSTTEC NO. 01.01.0913

OEM NO.

906 016 11 20
906 016 12 20
906 016 14 20

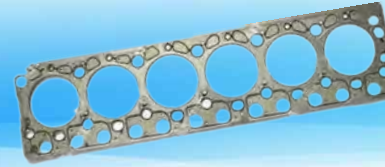

APPLICATION	CYLINDER	CAPACITY	YEAR
Om 906, OM 906 LA	6	6374	
ATEGO ATEGO 2 AXOR	6		01/98-10/04 10/04 01/02-10/04

OTHER NO.

61-36115-00,
082.732
082.733
082.734

Suitable for **Exhaust Manifold Gasket**

MERCEDES

TRUSTTEC NO. 01.01.0914

OEM NO.	APPLICATION	CYLINDER	CAPACITY	YEAR
314 142 03 80	OM 314	4	3780	1965 ON

OTHER NO.

71-24030-10,
108.367



TRUSTTEC NO. 01.01.0915

OEM NO.	APPLICATION	CYLINDER	CAPACITY	YEAR
314 142 04 80	OM 312, OM 352,	6	5675	1964 ON

OTHER NO.

71-24004-10
522.929



TRUSTTEC NO. 01.01.0916

OEM NO.	APPLICATION	CYLINDER	CAPACITY	YEAR
345 142 00 80 355 142 04 80 355 142 05 80	OM 326, OM 346, OM 355	6	11580	1967 ON

OTHER NO.

71-10447-60,
558.192



TRUSTTEC NO. 01.01.0917

OEM NO.	APPLICATION	CYLINDER
403 142 03 80	OM 476, OM 401, OM407,OM 421, OM 441, OM 445, OM 447	6
OTHER NO. 71-23079-00, 225.126,	OM 402, OM 422, OM 440, OM 442, OM 446	8
	OM 403, OM 423 OM 443	10



Suitable for **Exhaust Manifold Gasket**

MERCEDES

TRUSTTEC NO. 01.01.0918

OEM NO.	APPLICATION	CYLINDER
403 142 03 80	OM 476, OM 401, OM 407, OM 421, OM 441, OM 445, OM 447	6
OTHER NO. 71-23079-00, 225.126	OM 402, OM 422, OM 440, OM 442, OM 443	10



TRUSTTEC NO. 01.01.0919

OEM NO.	APPLICATION
541 142 04 80	OM 501, OM 502
OTHER NO. 71-35327-00 432.040	MERCEDES ACTROS



Exhaust Pipe Gasket

TRUSTTEC NO. 01.01.0920

OEM NO.	APPLICATION	CYLINDER	CAPACITY	YEAR
312 492 10 80 442 492 02 80	OM 312, OM 352, OM 353, OM 362	6	56	1964 ON

OTHER NO.

71-10534-10,
020.907



TRUSTTEC NO. 01.01.0921

OEM NO.	APPLICATION	CYLINDER
302 490 00 80	OM 401, OM 402, OM403,OM 404,	6
OTHER NO. 409.190		



Suitable for

Intake Manifold Gasket

MERCEDES

TRUSTTEC NO. 01.01.0922

OEM NO.

355 141 02 80

OTHER NO.

71-20231-30,
213.240



APPLICATION	CYLINDER	CAPACITY	YEAR
OM 346, OM 355	6	11580	1967 ON

TRUSTTEC NO. 01.01.0923

OEM NO.

51.08902.0161,
442 142 17 80
442 141 18 80
442 141 19 80

OTHER NO.

71-26069-20,
896.365



APPLICATION	CYLINDER
D 2555, D 2565, D 2865	5
D 2556, D 2566, D 2866, D 2876, E 2866, OM 401, OM 407, OM 421, OM 427, OM 441, OM 445, OM 447	6
D 2538, OM 402, OM 422, OM 440, OM 442, OM 466	8
D 2530, D 2540, D 2840, OM 403, OM 423, OM 443	10

TRUSTTEC NO. 01.01.0924

OEM NO.

51.08902.0161,
442 141 17 80
442 141 18 80
442 141 19 80

OTHER NO.

71-26069-20,
896.365



APPLICATION	CYLINDER
D 2555, D 2565, D 2865	5
D 2556, D 2566, D 2866, D 2876, E 2866, OM 401, OM 407, OM 421, OM 427, OM 441, OM 445, OM 447	6
D 2538, OM 402, OM 422, OM 440, OM 442, OM 466	8
D 2530, D 2540, D 2840, OM 403, OM 423, OM 443	10

TRUSTTEC NO. 01.01.0925

OEM NO.

801 09804

OTHER NO.

71-34033-00,
470.290



APPLICATION	CYLINDER
OM 521, OM 541,	6
OM 522, OM 542,	8

Suitable for

Valve Cover Gasket

MERCEDES

TRUSTTEC NO. 01.01.0926

OEM NO.

314 016 03 21

OTHER NO.

71-20335-20,
778.079

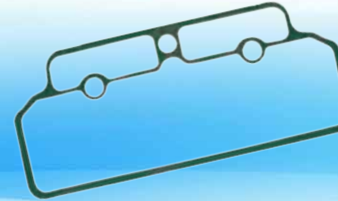

APPLICATION	CYLINDER	CAPACITY	YEAR
OM 312, OM 352, OM 353, OM 362	4	3780	1965 ON

TRUSTTEC NO. 01.01.0927

OEM NO.

352 016 09 21

OTHER NO.

71-19137-40,
777.773

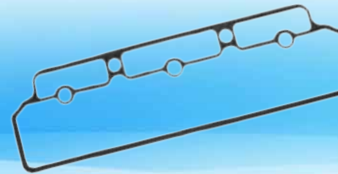

APPLICATION	CYLINDER	CAPACITY	YEAR
OM 312, OM 352, OM 353, OM 362	6	5675	1957-1959

TRUSTTEC NO. 01.01.0928

OEM NO.

355 016 00 21

OTHER NO.

71-20041-30,
775.525



APPLICATION	CYLINDER	CAPACITY	YEAR
OM 346, OM 355,	6	11580	1967 ON

TRUSTTEC NO. 01.01.0929

OEM NO.

442 016 06 21
442 016 07 21

OTHER NO.

71-23906-20,
977.438



APPLICATION	CYLINDER
M 476, OM 401, OM 406, OM 421, OM 427, OM 441, OM 445, OM 447	6
OM 402, OM 422, OM 440, OM 442, OM 448	8
OM 403, OM 423, OM 443	10

Suitable for

Valve Cover Gasket

MERCEDES

TRUSTTEC NO. 01.01.0930

OEM NO.

366 016 03 21

OTHER NO.

71-26284-30,
768.820

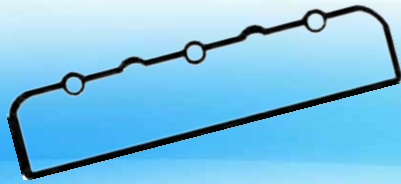

APPLICATION	CYLINDER	YEAR
OM 356, OM 357,	6	1984 ON

TRUSTTEC NO. 01.01.0931

OEM NO.

442 016 06 21
442 016 07 21

OTHER NO.

71-21032-20,
977.438



APPLICATION	CYLINDER
OM 476, OM 401, OM 406, OM 421, OM 427, OM 441, OM 445, OM 447	6
OM 402, OM 422, OM 440, OM 442, OM 446	8
OM 403, OM 423, OM 443	10

TRUSTTEC NO. 01.01.0932

OEM NO.

360 016 02 21

OTHER NO.

71-21032-20,
777.766

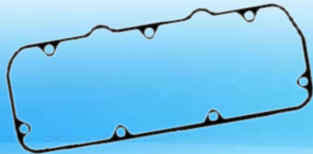

APPLICATION	CYLINDER
OM 327, OM 360	6

TRUSTTEC NO. 01.01.0933

OEM NO.

541 016 03 21

OTHER NO.

71-33799-00,
060.560



APPLICATION	CYLINDER
OM 521, OM 541, OM 522, OM 542,	6 8
MERCEDES ACTROS	

Suitable for

Head Gasket Set

MERCEDES

TRUSTTEC NO. 01.01.0934

OEM NO.

423 010 03 20

OTHER NO.

812.529

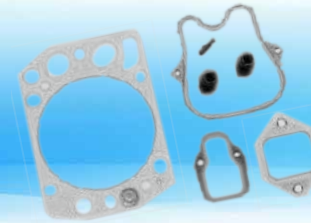

APPLICATION	CYLINDER
OM 401, OM 407, OM 421, OM 441, OM 402, OM 447	6
OM 402, OM 442, OM 440, OM 442, OM 446	8
OM 403, OM 423, OM 443	10

TRUSTTEC NO. 01.01.0935

OEM NO.

444 010 01 20

OTHER NO.

03-25105-08,
413.810

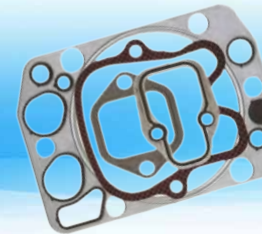

APPLICATION	CYLINDER
OM 401, OM 407, OM 421, OM 427, OM 441, OM 445, OM 447	6
OM 402, OM 422, OM 440, OM 442, OM 446	8
OM 403, OM 423, OM 443	10

TRUSTTEC NO. 01.01.0936

OEM NO.

541 010 25 20

OTHER NO.

03-34190-02,
711.442



APPLICATION	CYLINDER	CAPACITY	YEAR
OM 521, OM 541, OM 522, OM 542,	6 8	11946	1997 ON
MERCEDES ACTROS			

TRUSTTEC NO. 01.01.0937

OEM NO.

457 010 31 20
457 010 73 20

OTHER NO.

03-34285-01
712.541



APPLICATION	CYLINDER	CAPACITY	YEAR
OM 457		11967	01/02 ON

MERCEDES

TRUSTTEC NO. 01.01.0938

OEM NO. APPLICATION CYLINDER CAPACITY YEAR
 314 586 5190 OM 314 4 3780 1965 ON

OTHER NO.
 825.913

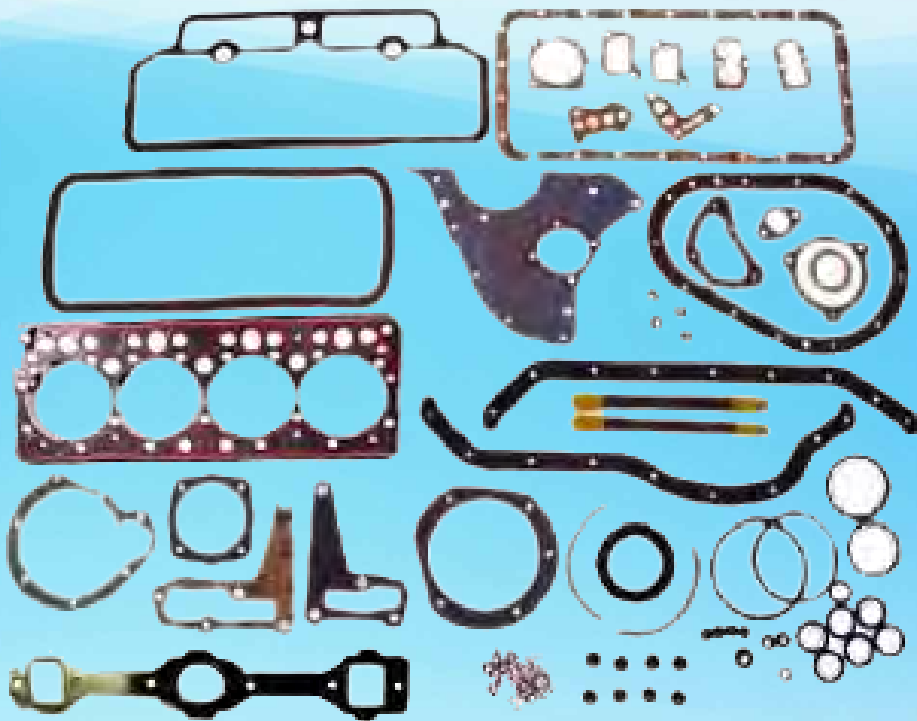

WASHER & O-RING DETAILS-ORDER BY SIZE		
Description	Qty.	
CU WASHER 16 X 20 MM ' 1.5	1	
CU WASHER 6 X 10 MM ' 0.9	2	
G4-2476 ASB GLAND PACKING	2	
CU WASHER 18 X 22 MM ' 1.6	12	
32.5X37.7X2.6 MM CU+ASB WASHER,22045WN01	1	
AL WASHER 20 X 24 MM ' 1.5	1	
CU WASHER 12.5 X 15.5 MM ' 1.5	2	
AL WASHER 22 X 27 MM ' 1.6	3	
24X32 MM CU+ASB WASHER,22045WM01	2	
CU WASHER 9.5 X 20 MM ' 1	2	
CU WASHER 20 X 24 MM ' 1.6	1	
CU WASHER 24 X 29 MM ' 2	1	
AL WASHER 12 X 15.5 MM ' 1.5	1	
AL WASHER 14 X 18 MM ' 1.6	5	
CRCA WASHER 22.2 X 28.8 MM ' 1.6	1	
CU WSR 22X27 22052W020 ' 1.6	1	
AL WASHER 10 X 13.5 MM ' 1	2	

WASHER & O-RING DETAILS-ORDER BY SIZE		
Description	Qty.	
AL WASHER 16 X 22 MM ' 1.5	2	
CU WASHER 11.4 X 8 MM BANCO NO : ' 1	2	
CU WASHER 8X12A MM 220 62 W170 ' 0.9	4	
G5-1908 HNR	1	
CU WSR 18X24 22052W010 ' 1.6	1	
MS WASHER 14 X 18 ' 1.6	1	
CU WASHER 8 X 12 MM ' 0.9	3	
AL WASHER 14X20 MM 220 62 W060 ' 1.6	12	
CU WASHER 8,0 X 14,0 MM ' 1	4	
AL WASHER 22.2 X 28,3 MM ' 1.5	4	
G5-1428 HNB	1	
22.4X26.8 MM CU+ASB WASHER,22069WS01	2	
AL WASHER 18 X 22 MM ' 2	2	
AL WASHER 26 X 32 MM ' 1	1	
CU WASHER 26 X 32 MM ' 1.6	1	
AL WASHER 26 X 31 MM ' 2	1	
CU WASHER 10 X 13.5 MM ' 0.9	7	

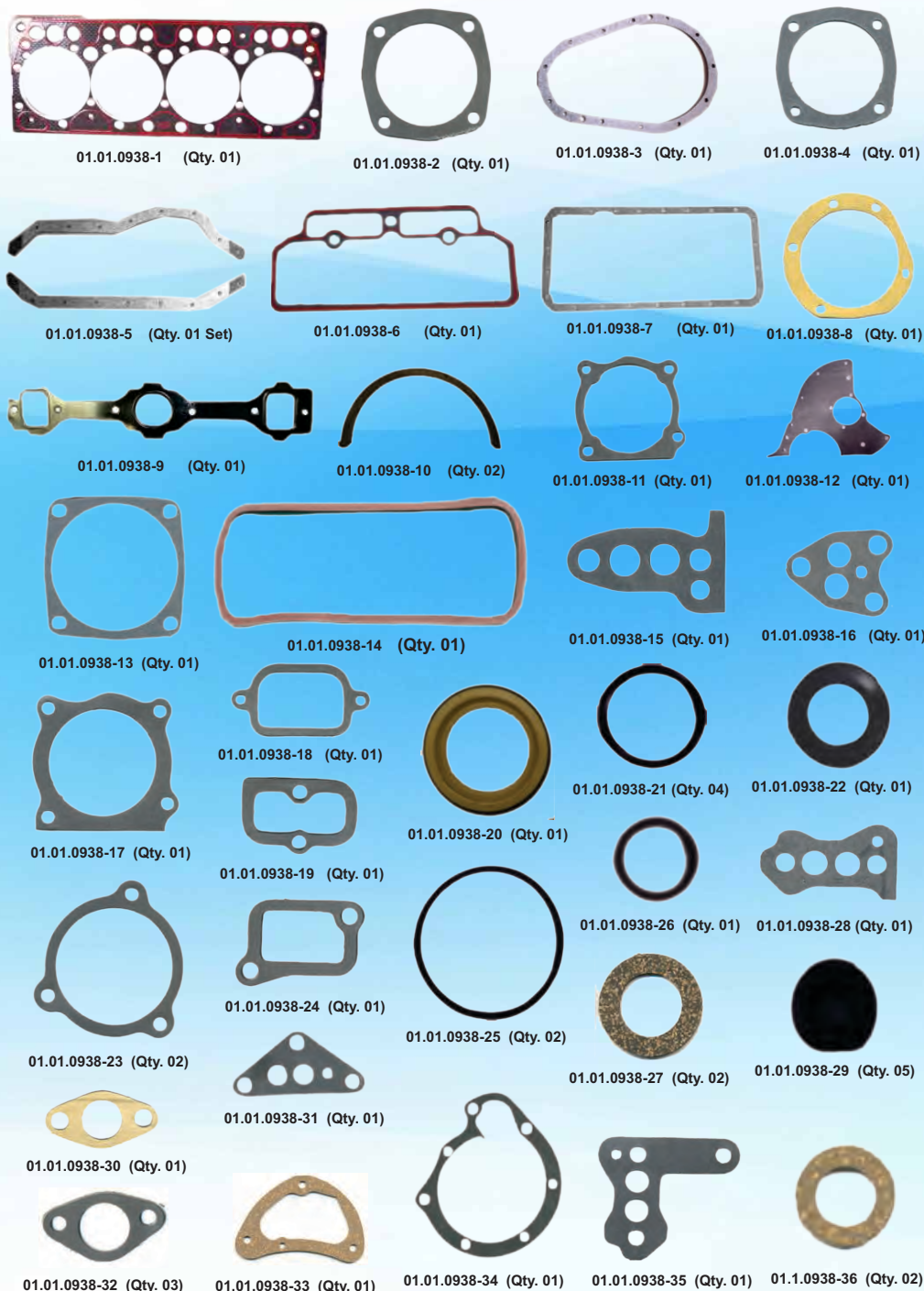

MERCEDES

TRUSTTEC NO. 01.01.0939

OEM NO. APPLICATION CYLINDER CAPACITY YEAR
 352 586 02 90 OM 352 6 5680 1964 ON

OTHER NO.
 826.871

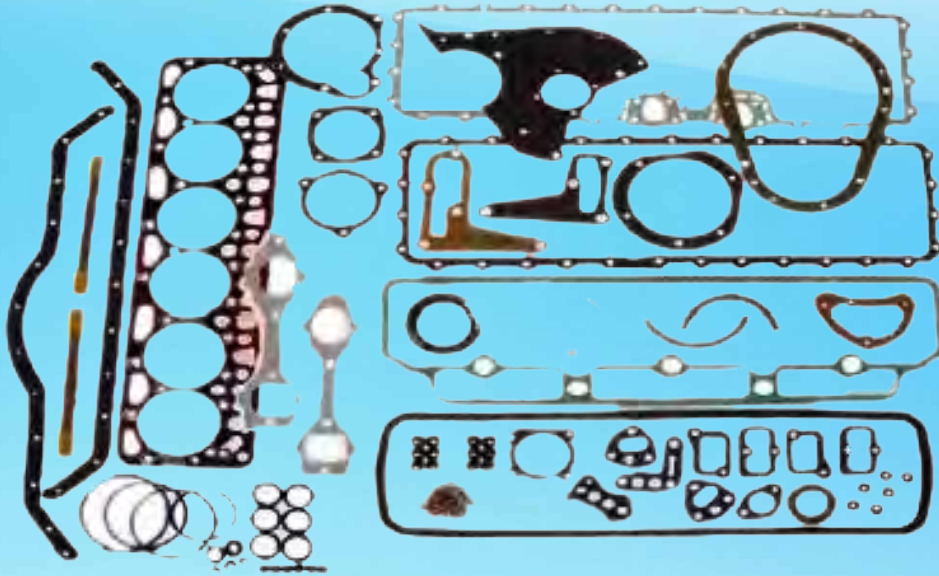

O-RING DETAILS- ORDER BY SIZE		
Description	Qty	
G5-1428 HNB	1	
G4-1435 ANB	1	
G4-1436	1	
G5-1437 ANB	6	
G5-1439 ASB	1	
G4-1441 BNB	1	
G5-1442 BNB	3	
G4-1425 GNB	1	
G5-1427 CNB	4	
G4-2476 ASB GLAND PACKING	2	
G4-417 BNB (ISSUE-4)	7	
G4-1440 ANB	1	
G5-1438 ANB	1	
CU WASHER 24 X 29 MM ' 2	1	
24X32 MM CU+ASB WASHER,22045WM01	1	
AL WASHER 26 X 32 MM ' 2	1	
FINAL PLAN 220 69 WN 0.18 CU/ASB 32X38	1	
CU WASHER 9.5 X 20 MM ' 1	6	

WASHER DETAILS-ORDER BY SIZE		
Description	Qty	
RF WASHER 10 X 16 MM ' 1	11	
CU WASHER 8X12A MM 220 62 W170 ' 0.9	6	
MS WASHER 8.0 X 12.0 MM ' 1	12	
CU WASHER 6 X 10 MM ' 0.9	2	
CU WASHER 8 X 11.5 MM ' 0.9	2	
CU WASHER 8.0 X 14.0 MM ' 1	7	
CU WASHER 10 X 13.5 MM ' 0.9	9	
CU WASHER 10 X 15 MM ' 1.6	2	
AL WASHER 12 X 15.5 MM ' 1.5	1	
FINAL PLAN 220 69 W0 0.18 CU/ASB 14X18	5	
CU WASHER 14 X 18 MM ' 1.5	9	
MS WASHER 14 X 18 ' 1.6	11	
AL WASHER 14 X 18 MM ' 1.6	5	
AL WASHER 14X20 MM 220 62 W060 ' 1.6	3	
CU WASHER 16 X 20 MM ' 1.5	2	
CU WASHER 16 X 20.5 MM ' 0.7	1	
AL WASHER 16 X 22 MM ' 1.5	2	
CU WASHER 18 X 22 MM ' 1.6	5	
AL WASHER 18 X 22 MM ' 1.6	11	
CU WSR 18X24 22052W010 ' 1.6	1	
FINAL PLAN 220 69 WP 0.18 CU/ASB 22X27	2	
AL WASHER 22 X 27 MM ' 1.6	1	

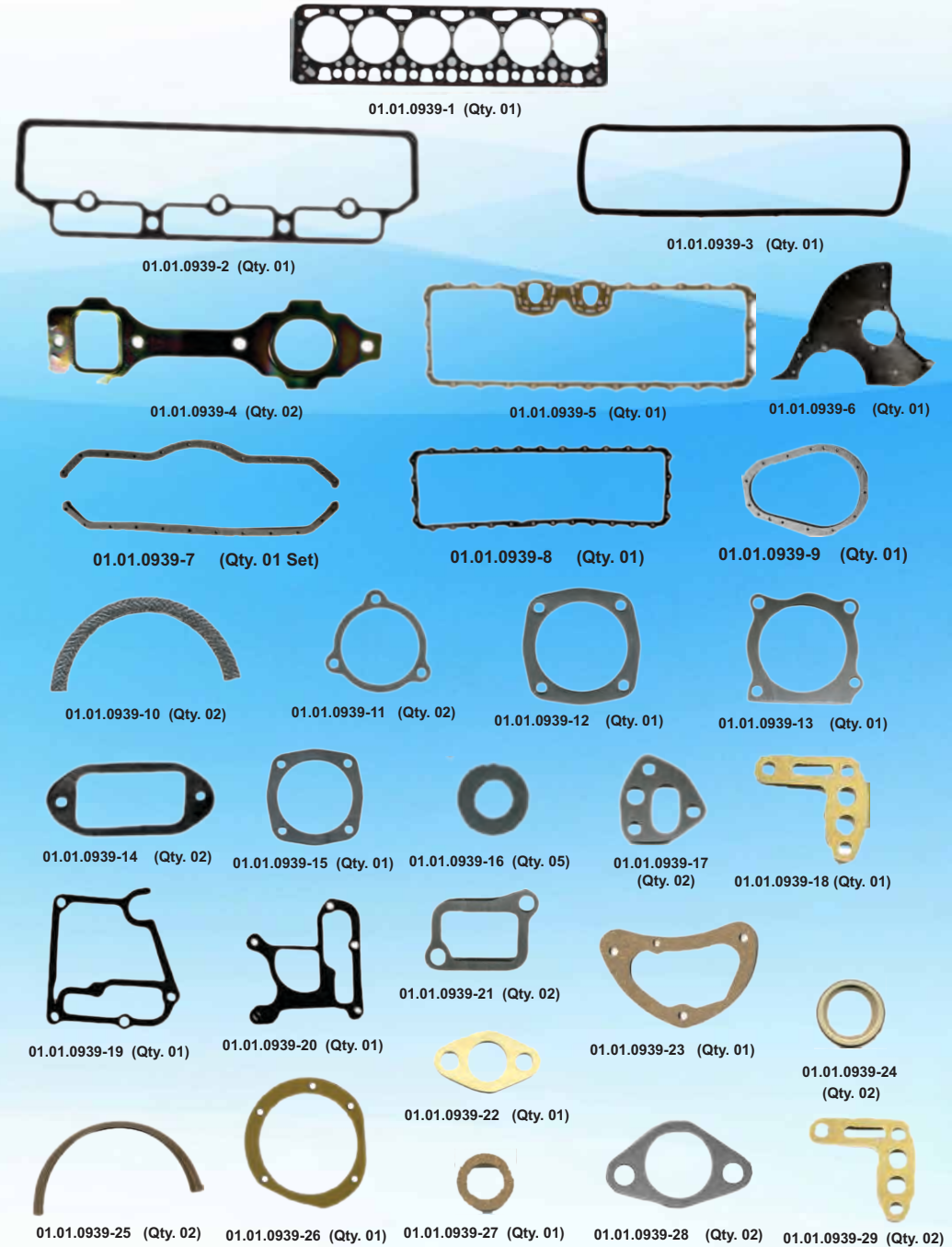

MERCEDES

TRUSTTEC NO. 01.01.0940

OEM NO. APPLICATION CYLINDER CAPACITY YEAR
 355 586 03 90 OM 346, OM 355 6 11580 1967 ON

OTHER NO.
 701.760

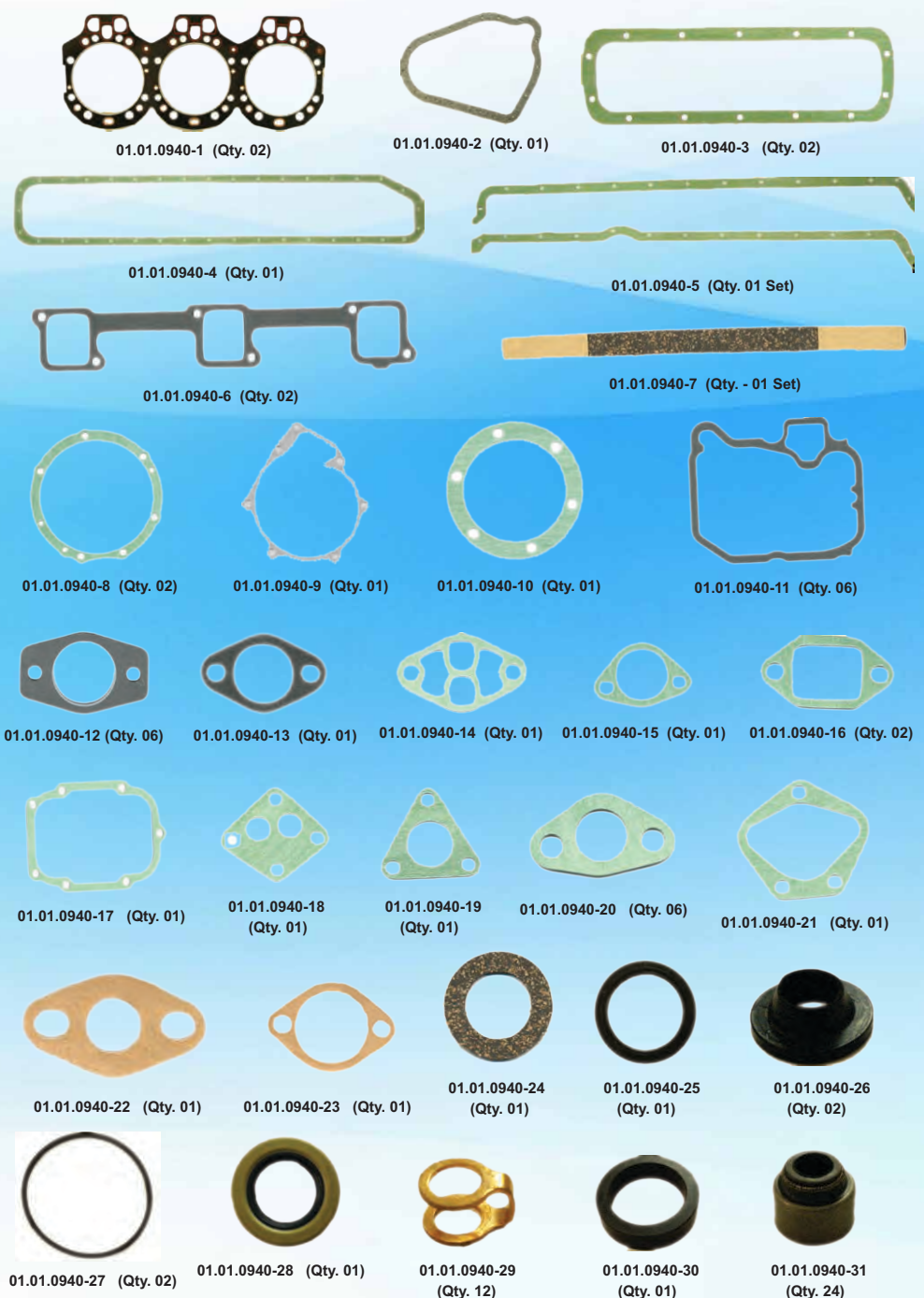
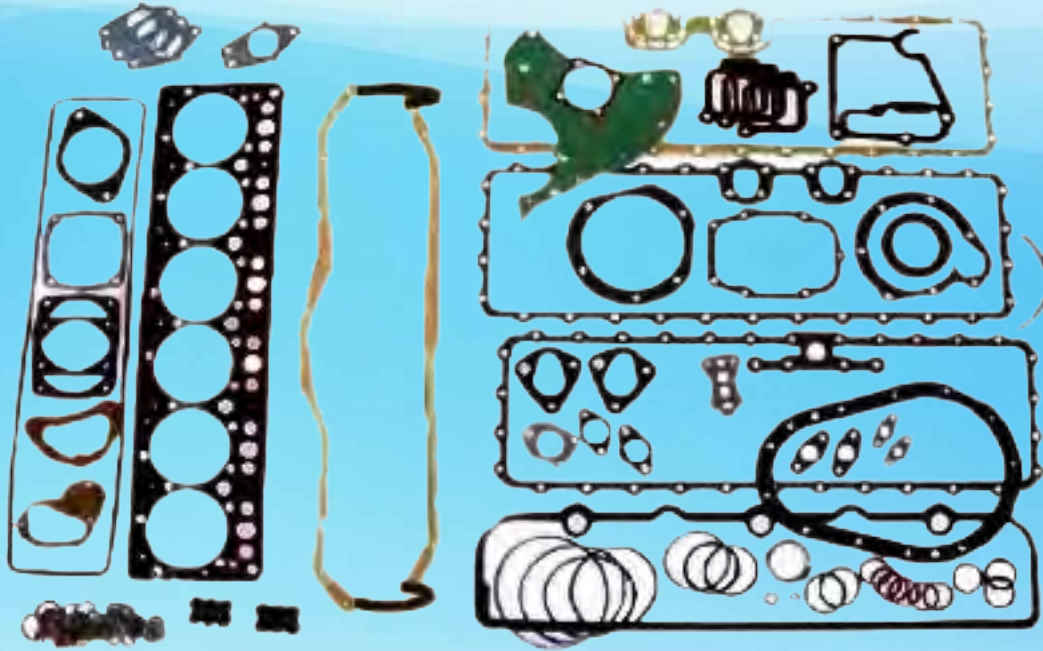

WASHER & O-RING DETAILS-ORDER BY SIZE

Description	Qty.
15.3 X 12.3	6
13.80 X 8.3	2
11.30 X 8.3	2
9.8 X 6.3	2
41 X 35.5 X 20	7
36 X 30 X 1.80	2
26.3 X 30.50	1
28.8 X 24.0	2
26.9 X 22.50	6
25.9 X 20.50	2
21.8 X 18.4	4
21.8 X 16.4 X 1.30	2
20 X 14.5 X 1.30	12
20.2 X 9.6 X 1.0	6
13.8 X 8.3 X 1	18

WASHER & O-RING DETAILS-ORDER BY SIZE

Description	Qty.
14.5 X 17.7	1
8 X 12 A	12
6.3 X 11.3 X 0.8	13
19.8 X 16.4 X 1.35	1
19.8 X 14.30 X 1.45	7
14.4 X 17.9 X 1.35	2
14.5 X 17.7	3
14.4 X 18 X 1.35	1
Silicon Rubber Black	1
Silicon Rubber Black	6
Nitrial Rubber Black	2
Silicon Rubber Black	1
Silicon Rubber Black	1

MERCEDES

TRUSTTEC NO. 01.01.0941

OEM NO. APPLICATION CYLINDER CAPACITY YEAR
 366 010 61 20 OM 366 5960 1984 ON

OTHER NO.
 02-27350-04,
 826.750

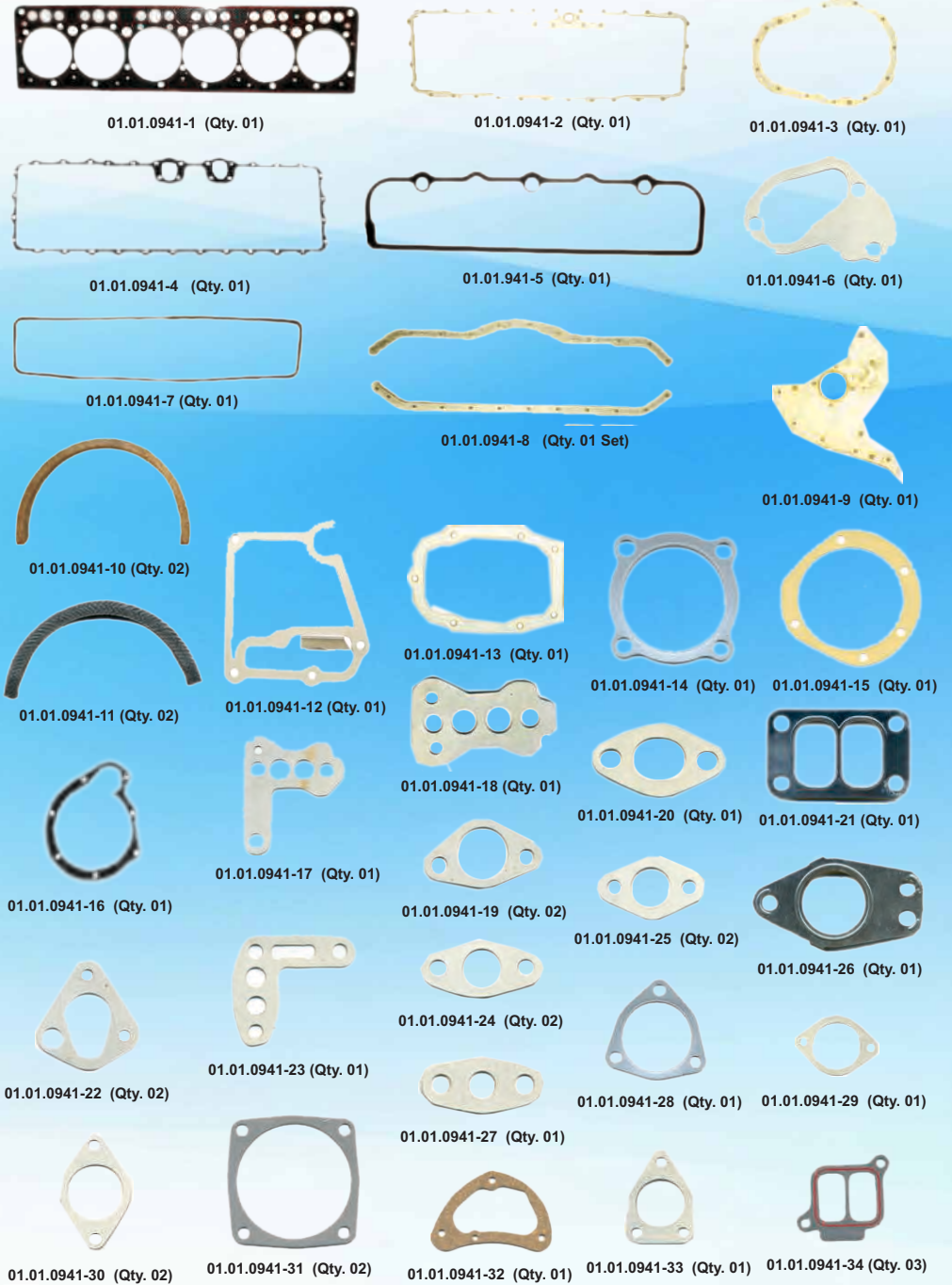
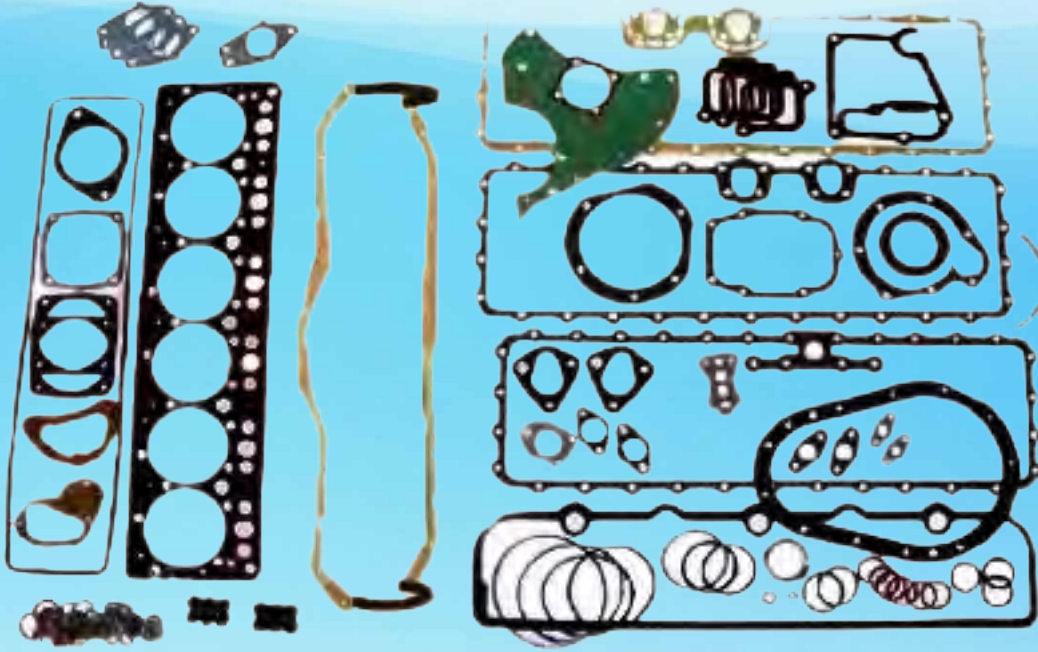

WASHER & O-RING DETAILS-ORDER BY SIZE

Description	Qty.
G43920/1CUWASHER35.8X30.35X1.8	1
G43920/2CUWASHER31.8X26.2X1.8	1
G4-3920/3ALWASHER19.8X14.2X1.4	15
G43920/4CUWASHER21.8X18.35X1.3	7
14.3X17.8CUWASANIAG3-3512/23	13
G43920/5CU WASHER19.8X9.5X1.0	6
G4-3919CU WASHER 12X8X1.0	6
G43920/6CUWASHER26.8X22X1.3	2
G43920/7CUWASHER19.8X14.35X1.3	3

WASHER & O-RING DETAILS-ORDER BY SIZE

Description	Qty.
G43920/8CU WASHER13.5X8.5X0.8	6
G43920/9CU WASHER11.5X8.35X0.8	13
G4-3904/1 SILICON RUB	1
G4-3904/2SILICON RUBBER O RING	1
G4-3904/3SILICONRUBBER O RING	2
G4-3905SILICON RUBBER SEAL	1
G4-3096/3 NIT.BLACK	2
G4-3904/4SILICON RUBBER O RING	6
G4-3909 SILICONRUBBER SEAL	7

MERCEDES

TRUSTTEC NO. 01.01.0942

OEM NO.	APPLICATION	CYLINDER	CAPACITY	YEAR
403 586 5190	OM 422 A OM 422 A/LA	8	14618	1973 - 96

OTHER NO.
826.642

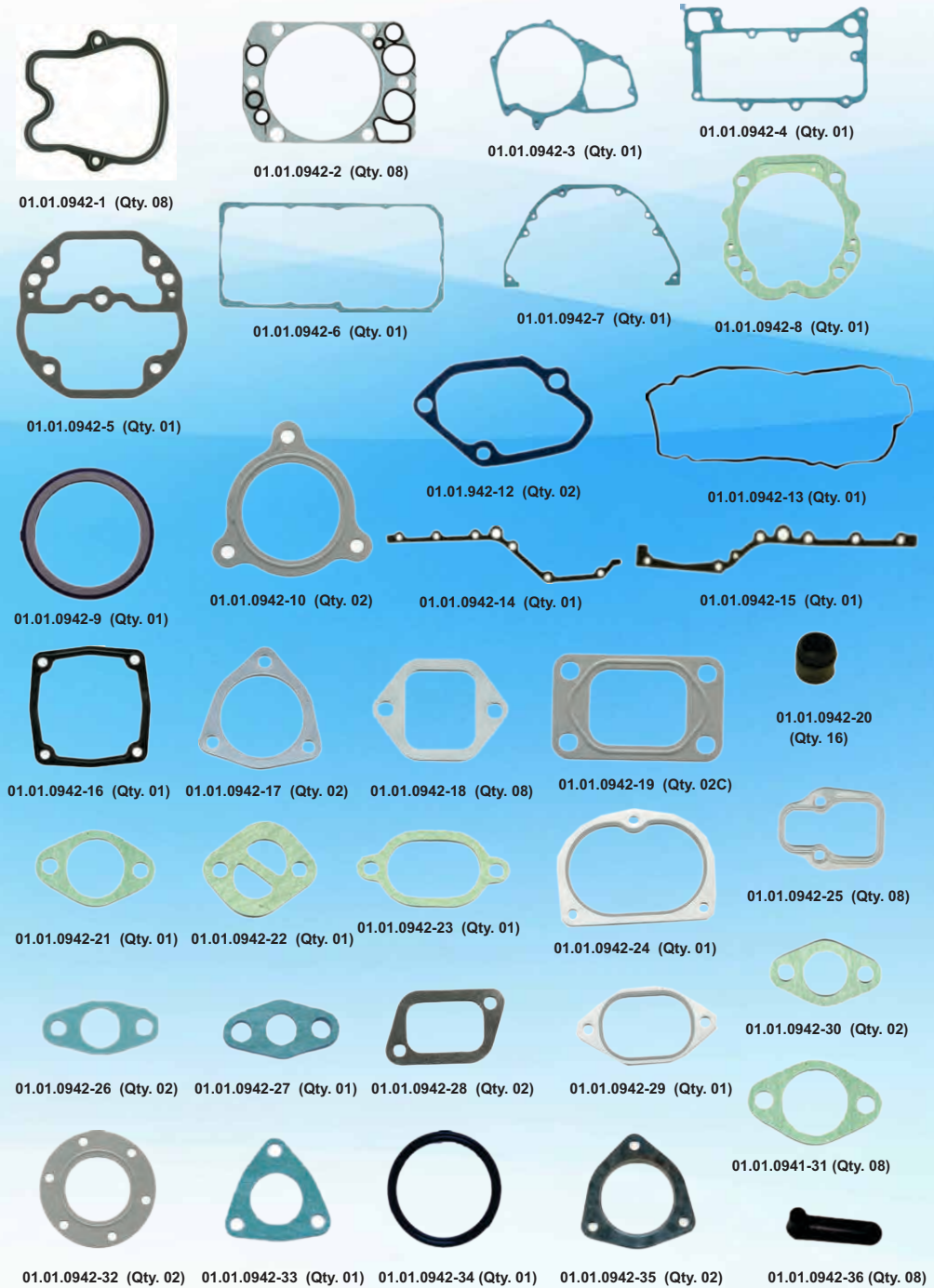

WASHER & O-RING DETAILS-ORDER BY SIZE		
Description	Qty.	
G3-3095 NIT.BLACK108 X 98 X 9 MM	1	
G4-3096/1 NIT.BLACK 142X134X4 MM	1	
G4-1441 BNB 81 X 74 X 3 MM	2	
G4-3096/3 NIT.BLACK 69X61X4 MM	2	
G4-3096/4 NIT.BLACK 16X12X2 MM	8	
G4-3096/5 NIT.BLACK 13X7X3 MM	1	
CU WASHER 38 X 44 MM * 1.8	1	
G4-3544/2 CU WASHER 30 X 36.1 X 1.8MM	4	
26.0 X 31.0 X 1.35 MM CU.	6	
CU WASHER 26.8X22.4 G3-4099/8 * 1.3	1	
CU WASHER 21.8X18.2 G3-4099/10 * 1.3	1	
CU WASHER 9.5 X 20 MM * 1	8	
CU WASHER 14.4X19.8 G3-3580/17 * 1.4	6	
CU WASHER 14.3X17.8 G4-3580/4 * 1.3	6	
G3-3580/2CU WAS 10.1X13.3X0.8 38058WB01	1	
CU WASHER 11.4X8 G3-3512/8 * 0.8	3	
CU WASHER 6.5 X 9.5 MM * 0.9	2	

WASHER & O-RING DETAILS-ORDER BY SIZE		
Description	Qty.	
CRCA WASHER 30 X 36 MM * 1.8	4	
CRCA WASHER 26 X 31 MM * 1.8	3	
CRCA WASHER 22.2 X 26.8 MM * 1.2	9	
CRCAWASHER14.2X17.8 G3-4099/18 * 1.4	6	
AL WASHER 14.1 X 19.7 MM * 1.3	12	
G4-3066 POLY. BLK COL.19.5 X 9.5 X 16.00 MM	16	
G4-4559, NITRILE RUB BLACK 95 X103X3.00	2	
G4-3096/2 NIT.BLACK 84X78X3 MM	1	
G4-4552/2, VITON RUBBER BLACK	4	
G4-4430/2,SILICON RUB. PANT.1805U(RED)	4	
G4-3534, SEAL	1	
G4-3583 AVB 36x42x3 ORING 380597101	1	
G4-4560,VITON RUBBER, BLACK COLOR	4	
G4-4431/2,NITRILE RUB BLACK 35.5 X 28 X 2.00 MM	1	

MERCEDES

TRUSTTEC NO. 01.01.0944

OEM NO.	APPLICATION	CYLINDER	CAPACITY	YEAR
	OM 401 LA, OM 441 A, OM 441 LA	6	9570	1987-96

OTHER NO.
914.959

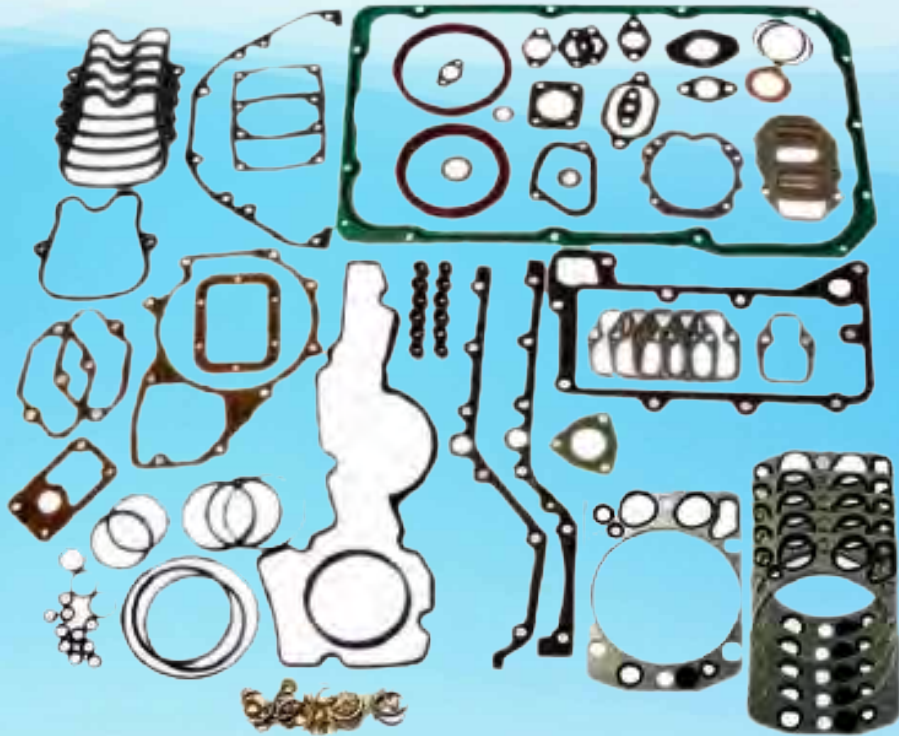

01.01.0944-1 (Qty. 01)



01.01.0944-2 (Qty. 01)



01.01.0944-3 (Qty. 01)



01.01.0944-4 (Qty. 01)



01.01.0944-5 (Qty. 01)



01.01.0944-6 (Qty. 01)



201.01.0944-8 (Qty. 01)

01.01.0944-9 (Qty. 01)

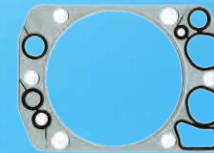

01.01.0944-7 (Qty. 06)

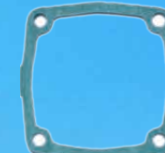

01.01.0944-11 (Qty. 02)



01.01.0944-12 (Qty. 06)



01.01.0944-13 (Qty. 01)



01.01.0944-10 (Qty. 01)



01.01.0944-15 (Qty. 01)

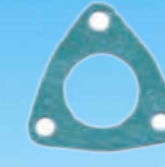

01.01.0944-16 (Qty. 01)



01.01.0944-17 (Qty. 01)



01.01.0944-14 (Qty. 06)



01.01.0944-19 (Qty. 06)



01.01.0944-20 (Qty. 01)



01.01.0944-21 (Qty. 02)



01.01.0944-18 (Qty. 01)



01.01.0944-22 (Qty. 01)



01.01.0944-23 (Qty. 02)



01.01.0944-24 (Qty. 01)

O-RING DETAILS-ORDER BY SIZE		
Description	Qty.	
G4-3532 ORING	1	
G4-3388 ORING BLACK	1	
G4-4431/2 NITBLACK RUB	1	
G4-3096/5 NIT.BLACK 13 X 7 X 3 MM	1	
G4-3066 POLY ACRYLIC BLK COL	12	
G3-4569 SILICON RUB GREY	2	
G4-4431/1 NITRILE RUB BLACK COL	1	
G4-2958/2 N RUB BLACK	4	
G4-4552/1 SILICON RUB BRICK	2	
G4-2946/5 NITRILE RUB	2	
G4-4560 VITON RUB BLACK COL	2	
G4-4430/1 VITON RUB BLACK COL	2	
G4-2946/3 NITRILE RUB BLACK COL	1	
G4-3096/2 NIT BLACK	1	
G3-3095 NIT BLACK	1	

WASHER DETAILS-ORDER BY SIZE			
Description	Drawing No.	Qty.	
12.3X16.8X1.50 MM ALU	NA	4	
20.2X25.7X1.50 MM ALU	NA	3	
26.2X30.8X1.8 MM ALU	NA	1	
26X32X2 MM ALU	NA	2	
G4-4252/310.2X16X0.8	NA	2	
G3-3512/226.X33.8	NA	1	
33.3X 38.9X2.0 CU	NA	1	
14.4X19.8X1.4 MM	G3-3580/17	7	
G3-3512/811.4X8	G4-3544/2	2	
30 X 36.1 X 1.8MM CU	NA	5	
26.8X22.4X1.3 CU	G3-4099/18	1	
CU 21.8X18.2X1.3	G3-4099/10	2	
9.5 X 20X1 MM CU	NA	6	
26.3X30.9X2X2MM	G4-3544/3	4	
22.2X26.8X1.2MM	NA	1	
14.2X17.8X1.4 MM	G3-4099/18	1	

MERCEDES

TRUSTTEC NO. 01.01.0945

OEM NO.	APPLICATION	CYLINDER	CAPACITY	YEAR
	OM 422	8	15080	1987-96

OTHER NO.

914.959



O-RING DETAILS-ORDER BY SIZE		
Description	Qty.	
G4-3066 POLY ACRYLIC BLK COL	16	
G4-2958/2 N RUB BLACK	4	
G4-4430/1 VITON RUB BLACK COL	2	
G4-2946/3 NITILE RUB BLACK COL	1	
G4-3510 NIT RUB BLACK	1	
G3-3095 NITBLACK 108 X 98 X 9 MM	1	
G4-3096/1 NITBLACK 142 X 134 X 4 MM	1	
G4-4431/1,NITRILE RUBBLAC COL	1	
G4-3096/3 NIT.BLACK 69 X 61 X 4 MM	2	
G4-3096/2 NIT BLACK	1	
G4-3096/5 NIT.BLACK 13 X 7 X 3 MM	1	
G4-4431/2 NITRILE RUB BLACK COL	1	

WASHER DETAILS-ORDER BY SIZE		
Description	Qty.	
26.2X31.0X1.20 MM CU WASHER	5	
G4-3544/2 CU WASHER 30 X 36.1 X 1.8MM	5	
CU WASHER 26.8X22.4 G3-4088/8	1	
CU WASHER 21.8X18.2 G3-4099/10 ' 1.3	2	
CU WASHER 9.5 X 20 MM ' 1	8	
CU WASHER 14.4X19.8 G3-3580/17 ' 1.4	12	
CU WASHER 14.3X17.8 G4-3580/4 ' 1.3	1	
CU WASHER 11.4X8 G3-3512/8 ' 0.8	2	
14.2X17.8 G3-4099/18 CRCA WASHER	1	
G4-1707	1	
33.3X38.9X2.0 MM CU WASHER	1	
CU WASHER 26.2X33.8 G3-3512/2	1	
26.2X33.8X1.80 MM CRCA WASHER	1	
26.5X31.5X1.80 MM CRCA WASHER	1	
CU WASHER 10.3X14 MM	1	
G4-4252/3 CU WAS. 10.2X16X0.8	2	

01.01.0945-1 (Qty. 08)

01.01.0946-2 (Qty. 01)

01.01.0945-3 (Qty. 01)

01.01.0945-4 (Qty. 01)

01.01.0945-5 (Qty. 01)

01.01.0945-6 (Qty. 01)

01.01.0945-7 (Qty. 01)

01.01.0945-8 (Qty. 01)

01.01.0945-9 (Qty. 01)

01.01.0945-10 (Qty. 02)

01.01.0945-11 (Qty. 08)

01.01.0945-12 (Qty. 01)

01.01.0945-13 (Qty. 02)

01.01.0945-14 (Qty. 01)

01.01.0945-15 (Qty. 01)

01.01.0945-16 (Qty. 01)

01.01.0945-17 (Qty. 02)

01.01.0945-18 (Qty. 02)

01.01.0945-19 (Qty. 08)

01.01.0945-20 (Qty. 08)

01.01.0945-21 (Qty. 08)

MERCEDES

TRUSTTEC NO. 01.01.0946

OEM NO.	APPLICATION	CYLINDER	CAPACITY	YEAR
401 586 00 90	OM 401	6	9570	

OTHER NO.
914.940

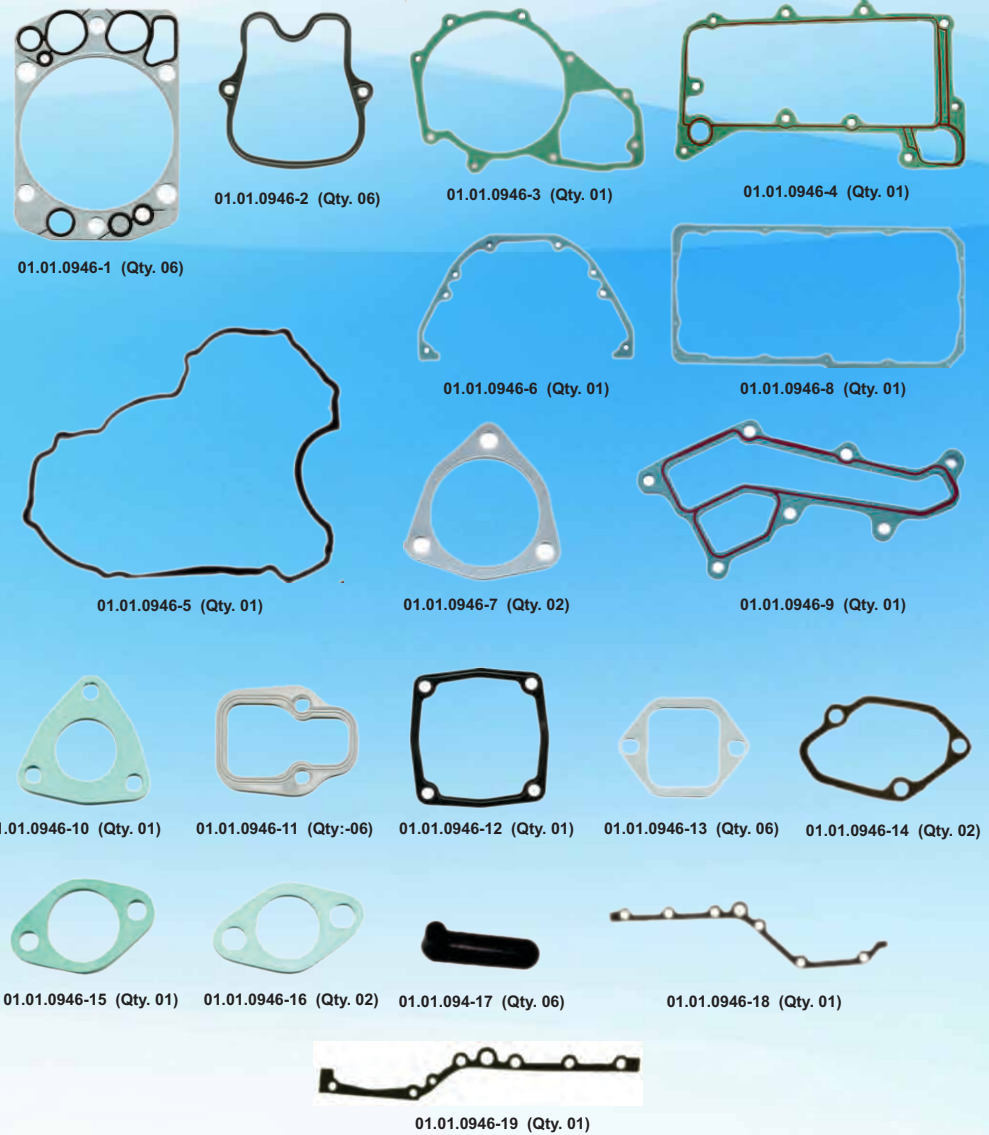

WASHER & O-RING DETAILS-ORDER BY SIZE		
Description	Qty.	
G3-3064 SIL.BLACK	1	
G3-3065 SIL.BLACK	1	
G3-3095 NIT.BLACK	1	
G4-3096/2 NIT.BLACK	1	
G4-3096/3 NIT.BLACK	2	
G4-3096/5 NIT.BLACK	1	
G4-3544/2 CU WASHER 30 X 36.1 X 1.8MM	5	
CU WASHER 26.8X22.4 G3-4099/8 '1.3	1	
G4-3544/4 CU WASHER 18.2X21.9X1.4MM	2	
CU WASHER 9.5 X 20 MM '1	6	
CU WASHER 14.4X19.8 G3-3580/17 ' 1.4	5	
CU WASHER 14.3X17.8 G4-3580/4 ' 1.3	1	
CU WSR 16220710142 10.2X13.9 ' 1	1	
CU WASHER 11.4X8 G3-3512/8 '0.8	2	
CRCA WASHER 26 X 31 MM ' 1.8	1	
G4-3066 POLY ACRYLIC BLK COL	12	
G4-4431/1.NITRILE RUBBER BLACK COLOR	1	

WASHER & O-RING DETAILS-ORDER BY SIZE		
Description	Qty.	
G4-2958/2 N RUB BLACK	4	
G4-4430/1.VITON RUBBER BLACK COLOR	2	
G4-3583 AVB 36x42x3 ORING 380597101	1	
G4-4431/2.NITRILE RUBBER BLACK COLOR	1	
G4-3510 NIT RUB BLACK	1	
G4-3357 O-RING ANR	1	
33.3 X 38.9 X 2.0 MM CU. WASHER	1	
CU WASHER 26.2X33.8 G3-3512/2 ' 2	2	
26.2 X 31.0 X 1.20 MM CU. WASHER	4	
AL WASHER 26 X 32 MM ' 2	1	
G4-4252/3 CU.WAS.10.2x16x0.8 38056WC01	2	

MERCEDES

TRUSTTEC NO. 01.01.0947

OEM NO.	APPLICATION	CYLINDER	CAPACITY	YEAR
541 010 05 05	OM 501 LA	6	11946	1996-02

OTHER NO.
166.340

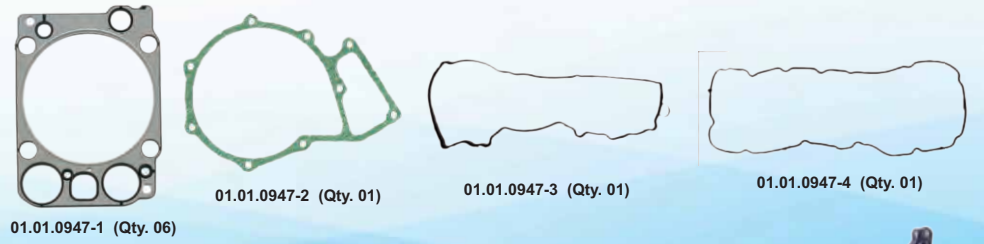
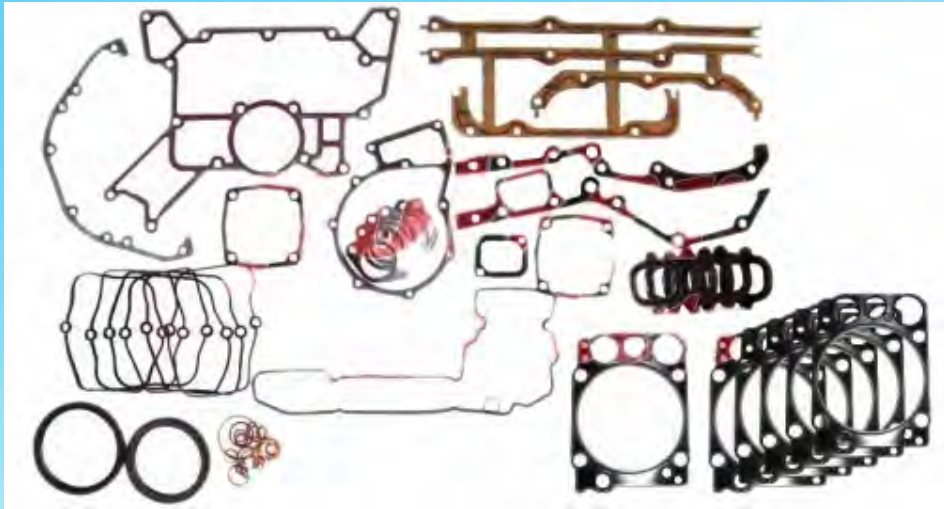

MERCEDES

TRUSTTEC NO. 01.01.0948

OEM NO.	APPLICATION	CYLINDER	CAPACITY	YEAR
541 010 05 05	OM 501 LA	8	15928	1996-02

OTHER NO.
166.350

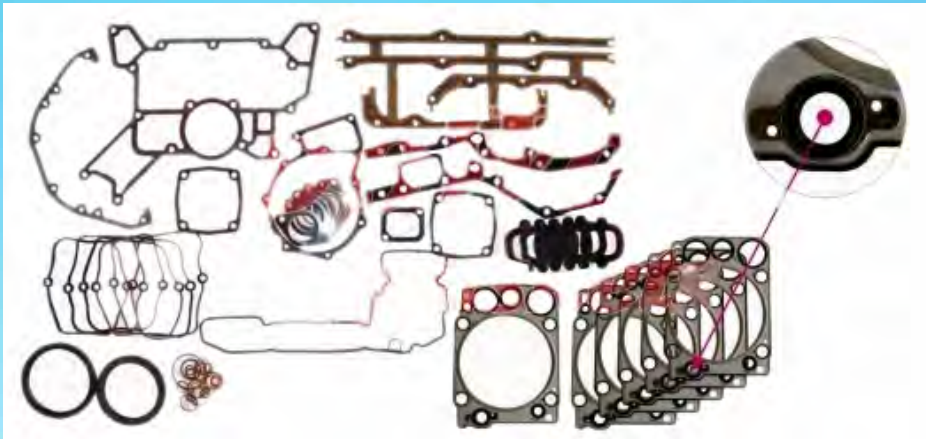

01.01.0948-1 (Qty. 01)



01.01.0948-2 (Qty. 01)

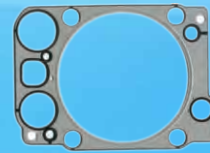

01.01.0948-3 (Qty. 08)



01.01.0948-4 (Qty. 01)



01.01.0948-5 (Qty. 01)



01.01.0948-6 (Qty. 01)



01.01.0948-7 (Qty. 02)



01.01.0948-8 (Qty. 01)

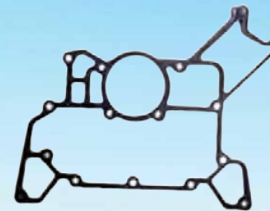

01.01.0948-9 (Qty. 01)

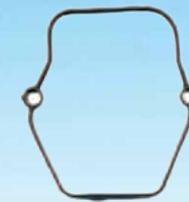

01.01.0948-10 (Qty. 08)



01.01.0949-11 (Qty. 01)

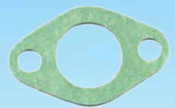

01.01.0949-12 (Qty. 02)

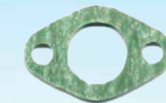

01.01.0948-13 (Qty. 01)



01.01.0948-14 (Qty. 01)

MERCEDES

TRUSTTEC NO. 01.01.0959

OEM NO.	APPLICATION	CYLINDER	CAPACITY	YEAR
541 010 04 05	OM 501 LA	8	15928	1996-02

OTHER NO.
166.370

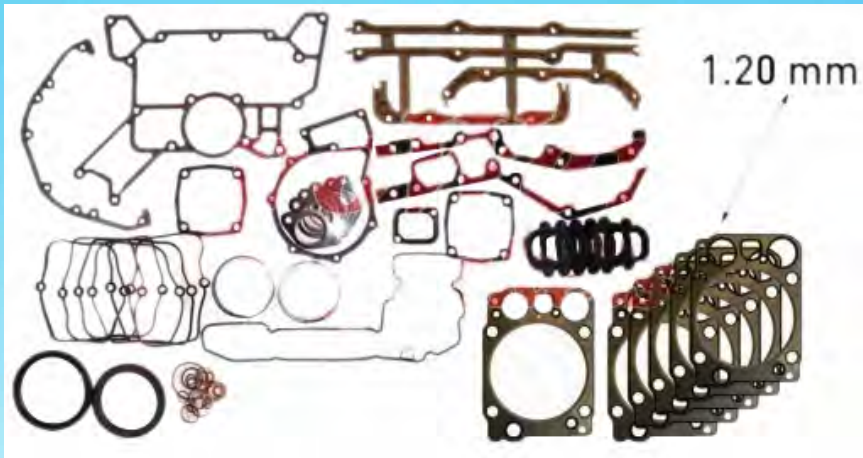

01.01.0959-1 (Qty. 01)



01.01.0959-2 (Qty. 01)

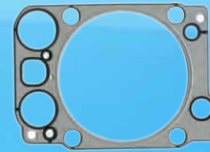

01.01.0959-3 (Qty. 08)



01.01.0959-4 (Qty. 01)



01.01.0959-5 (Qty. 01)



01.01.0959-6 (Qty. 01)



01.01.0959-7 (Qty. 02)



01.01.0959-8 (Qty. 01)

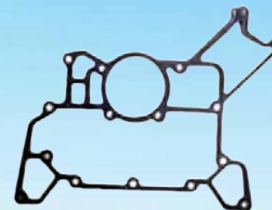

01.01.0959-9 (Qty. 01)

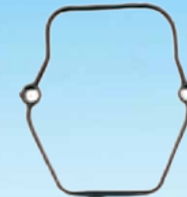

01.01.0959-10 (Qty. 08)



01.01.0959-11 (Qty. 01)

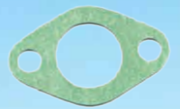

01.01.0959-12 (Qty. 02)

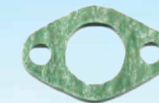

01.01.0959-13 (Qty. 01)



01.01.0959-14 (Qty. 01)

Suitable for

Cylinder Head Gasket

RENAULT

TRUSTTEC NO. 030.01.0901

OEM NO.	APPLICATION	CYLINDER	CAPACITY	YEAR
50 10 295 726, 50 00 670 202, 00 00 771 149	MID 06.20.30, MIDR 06.20.30 / 45, MIDS 06.20.30 / 45	6	9840	1985-98

OTHER NO.
61-31115-00, 30-025716-00, 569.320



Head Set Gasket

RENAULT

TRUSTTEC NO. 030.01.0902

OEMNO.	APPLICATION	CYLINDER	CAPACITY	YEAR
50 00 793 228000 793 626, 50 00 793 734, 50 01 826 884	MID 06.20.30, MIDR 06.20.30 / 45, MIDS 06.20.30 / 45	6	9840	1985-98

OTHER NO.
569.500



Suitable for

Cylinder Head Gasket

RENAULT

TRUSTTEC NO. 030.01.0903

OEM NO.	APPLICATION	CYLINDER	CAPACITY	YEAR
74 20 495 935	Renault Kerax 370.18, 370.26, 410.18 410.26, 410.32, 450.18, 450.26, 450.32	6	10800	10/2005

OTHER NO.	APPLICATION	CYLINDER	CAPACITY	YEAR
225.100	Renault Premium 2 Distribution 370.18D, 370.26, 380.18, 380.19, 410.8D, 410.26, 430.18, 430.19, 430.26, 450.18D, 460.19	6	10800	10/2005
	Renault Premium 2 Lander 380.19, 380.26, 430.18, 430.26, 440.18, 440.19, 440.32, 460.18, 460.26	6	10800	10/2006
	Renault Premium 2 Route 330.18 T, 380.18, 380.19, 380.26, 410.18, 410.18D, 410.24, 410.25, 410.26, 430.19, 430.26, 450.18, 450.18D, 450.24, 450.25, 450.26, 460.18, 460.26	6	10800	10/2006

Renault Dxi 11



Suitable for

Cylinder Head Gasket

RENAULT

TRUSTTEC NO. 030.01.0904

OEM NO.	APPLICATION	CYLINDER	CAPACITY	YEAR
74 20 513 037	Renault Kerax 460.32 / 500.32	6	12800	05/2006
OTHER NO. 61-36855-00 548.500	Renault Magnum Dxi 13 460.18T, 460.24, 460.25, 460.26, 460.26T, 500.18T, 500.24, 500.25, 500.26, 500.26T	6	12800	05/2006
	Renault Magnum Dxi 520.19, 520.24, 520.25, 520.26	6	12800	08/2009
	Renault Dxi 13 / Dxi			

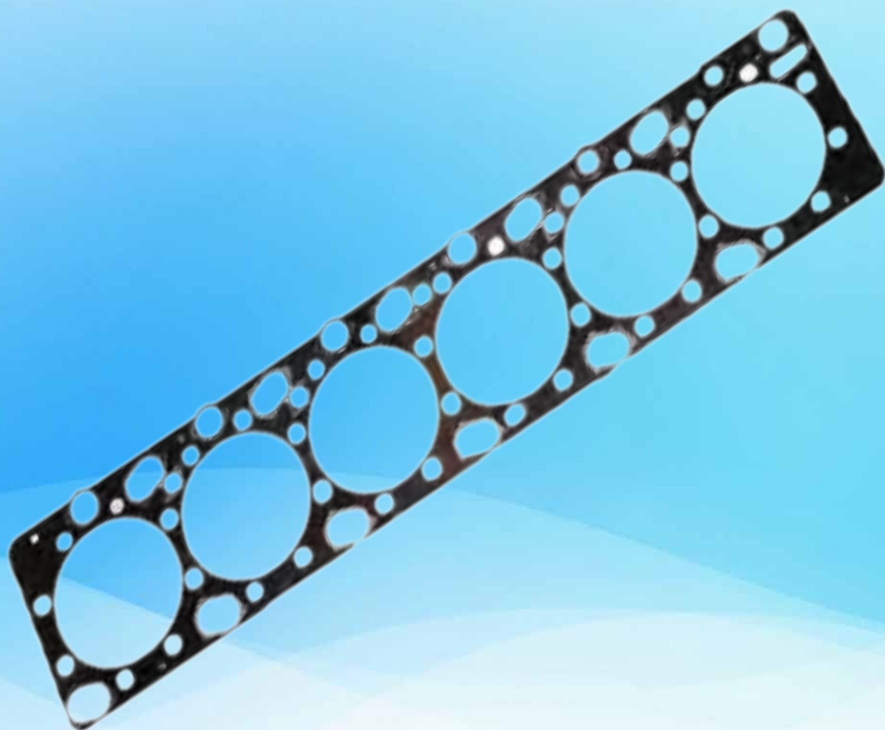

Suitable for

Cylinder Head Gasket

SCANIA

TRUSTTEC NO. 030.01.0905

OEM NO.	APPLICATION	CYLINDER	CAPACITY	YEAR
170274-5	D 14,	8	1420	1969 ON
OTHER NO.				



TRUSTTEC NO. 030.01.0906

OEM NO.	APPLICATION	CYLINDER	CAPACITY	YEAR
177 014 161 870	D 11,	6	1100	1963-1974
OTHER NO. 60-24805-10, 000.442				

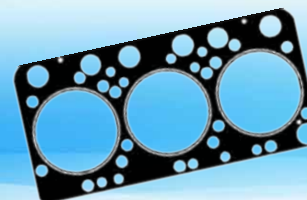

TRUSTTEC NO. 030.01.0907

OEM NO.	APPLICATION	CYLINDER	CAPACITY	YEAR
373 472	DN 11, DS 11,	6	8475	1980 ON
OTHER NO. 61-31220-00, 893.463				

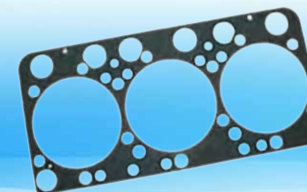

TRUSTTEC NO. 030.01.0908

OEM NO.	APPLICATION	CYLINDER	CAPACITY	YEAR
1 313 459, 1 403, 587	Ds 14 DSC 14	8	11020	1980 ON
OTHER NO. 61-31050-00, 893.472				



Suitable for Cylinder Head Gasket

SCANIA

TRUSTTEC NO. 06.01.0401

OEM NO.

1 403 258,
291 159
346 216
387 503

OTHER NO.

61-31160-00,
893-463

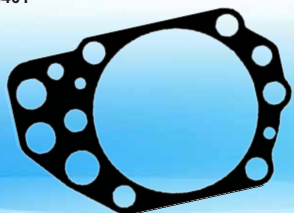

APPLICATION	CYLINDER	CAPACITY	YEAR
DS 9, DSC 9,	6	8475	1980 ON

TRUSTTEC NO. 06.01.0402

OEM NO.

257 381

OTHER NO.

61-25380-10,
347.523

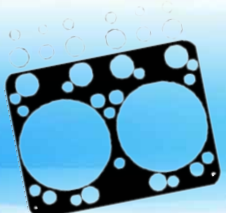

APPLICATION	CYLINDER	CAPACITY	YEAR
D 8, DS 8, DSI 8	6	7800	1980 ON

TRUSTTEC NO. 06.01.0403

OEM NO.

1 377 039
1 403 260
1 444 941

OTHER NO.

61-34880-00,
125.780



APPLICATION	CYLINDER	CAPACITY	YEAR
DSC 12, DC 12,	6	10600	1980 ON

TRUSTTEC NO. 06.01.0404

OEM NO.

1 403 603,
1 468 555

OTHER NO.

61-34885-00,
125.830



APPLICATION	CYLINDER	CAPACITY	YEAR
DS 16	6	11700	2000 ON

Suitable for Head Gasket Set

SCANIA

TRUSTTEC NO. 06.01.0405

OEM NO.

550099-6

APPLICATION	CYLINDER	CAPACITY	YEAR
D 14,	8	14200	1969 ON



TRUSTTEC NO. 06.01.0406

OEMNO.

551 500,
551 512

OTHER NO.

02-31220-02,
921.807

APPLICATION	CYLINDER	CAPACITY	YEAR
DN 11, DS 11	6	11020	1980 ON

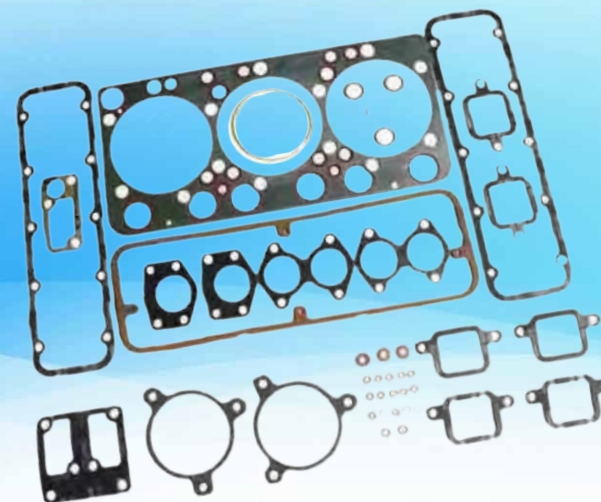

Suitable for

Head Gasket Set

SCANIA

TRUSTTEC NO. 06.01.0407

OEM NO.	APPLICATION	CYLINDER	CAPACITY	YEAR
550 214, 551 469	D 14, DS 14, DSC 14	8	14200	1980 ON

OTHER NO.

03-31050-01,
586.627



TRUSTTEC NO. 06.01.0408

OEM NO.	APPLICATION	CYLINDER	CAPACITY	YEAR
551 484	DS 9, DSC 9	6	8475	1989 ON

OTHER NO.

03-31160-01
922.129
21-26849-21/0



Suitable for

Head Gasket Set

SCANIA

TRUSTTEC NO. 06.01.0409

OEM NO.	APPLICATION	CYLINDER	CAPACITY	YEAR
551 363	DSC 12, DC 12,	6	10600	1996 ON

OTHER NO.

03-34880-01,
138.501

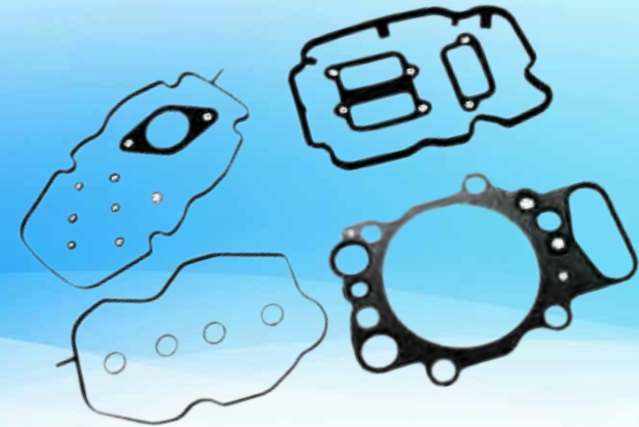

TRUSTTEC NO. 06.01.0410

OEM NO.	APPLICATION	CYLINDER	CAPACITY	YEAR
550 469	DC 16	6	11700	2000 ON

OTHER NO.

03-34885-01
138.491



TRUSTTEC NO. 06.01.0411

OEM NO.	APPLICATION	CYLINDER	CAPACITY	YEAR
551 470	DS 14, DSC 14	8	14190	1988 - 96

OTHER NO.
597.717

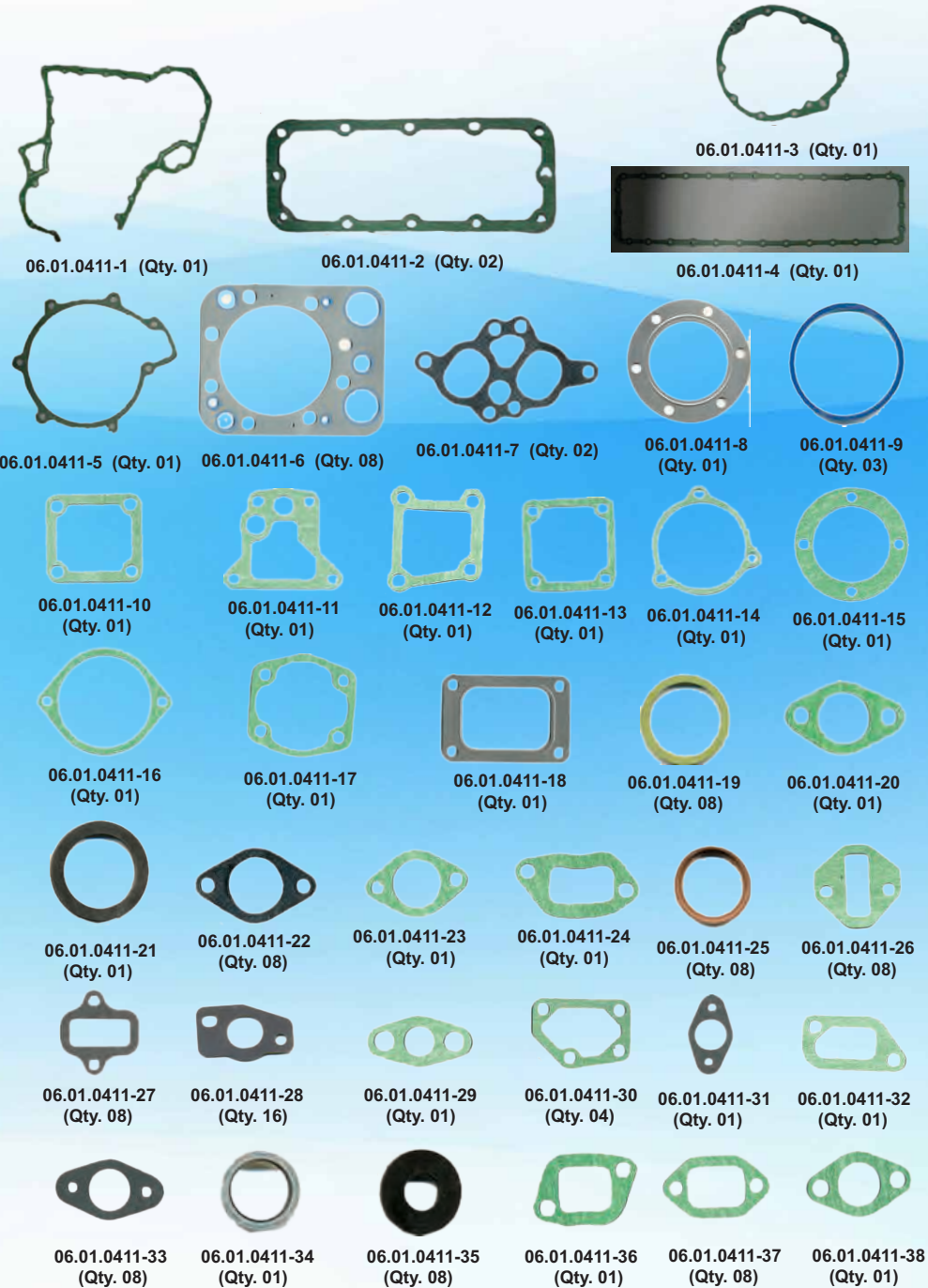

O-RING DETAILS-ORDER BY SIZE		
Description		Qty.
SILCON RUB.(YELLOW)	G4-4712	1
SILCON RUB.(BLUE)	G4-4420	1
SILCON RUB.(YELLOW)	G4-3505	1
NITRILE RUB.(GREEN)	G4-1217/5	4
VITON RUB.(BLACK)	G4-3515	2
VITON RUB.(BROWN)	G4-3515	1
SILCON(BLACK)	G4-3494	1
NITRILE RUB.(BLACK)	G5-2496/1	1
NITRILE RUB.(BLACK)	G4-3493	1
NITRILE RUB.(BLACK)	G4-3499/1	1
VITON RUB.(LIGHT GREEN)	G4-3507	1
SILCON RUB.(BLACK)	G4-3459	1
SILCON RUB.(BLACK)	G4-3511	1
SILCON RUB.(BLACK)	G4-3509	1
VITON RUB.(LIGHT GREN)	G4-3502	1
VITON RUB.(LIGHT GREN)	G4-4711	1
VITON RUB.(LIGHT GREN)	G4-4711	16

Description		Qty.
2.3X25.9X1.30 MMCU	G3-4099/9	2
23.7X18.5X1.0 ALU		1
21.7X18.3X1.40 MMCU	G4-3544/4	2
20X16X1.30 MMCU	G4-3580/18	2
15.8X12.3X1.50 MMALU		4
14.8X10.3X1.0XMM ALU		5
10.1X0.80 MM CU	G4-3580/25	8
SPRIG STEEL	G4-4426	1

WASHER DETAILS-ORDER BY SIZE		
Description		Qty.
SPRING STEEL	G4-3546	16
41.8X36.2X1.80 MM ALU	G3-3512/1	1
33.8X26.2X2 MM CU	G3-3512/2	4
31X26.5X2 MM CU	G3-3512/4	1
11.3X8.2X0.80 MM CU	G3-3512/8	25
168X14.3X1.30 MM ALU	G3-3512/10	3
37.8X24.3X0.80XMM ALU	G4-3512/11	1
20X9.4X1.80 MM CU	G3-3512/16	8
21.7X16.3X0.80 MMCU	G3-3512/17	2
19.7X14.3X1.35 MMCU	G3-3580/17	30
22.7X20X1.0 MMCU		3
50X44.5 MM	G43514/1	1
25.8X22.3X1.35 MMALU		4

SCANIA

TRUSTTEC NO. 06.01.0412

OEM NO.	APPLICATION	CYLINDER	CAPACITY	YEAR
551 519	DS 11, DSC 11, DTC 11	6	11020	1980 ON
OTHER NO.				
922.332				

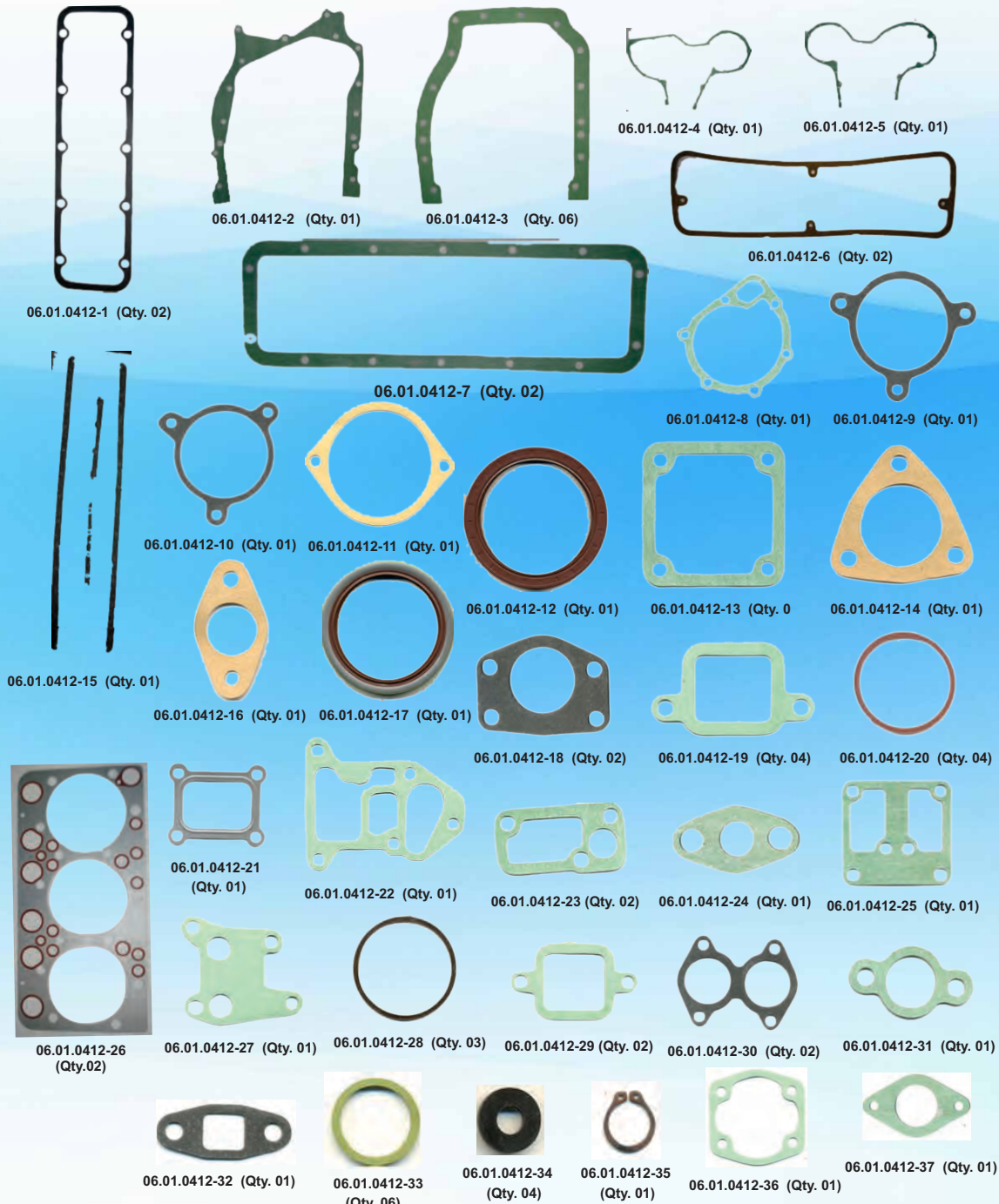
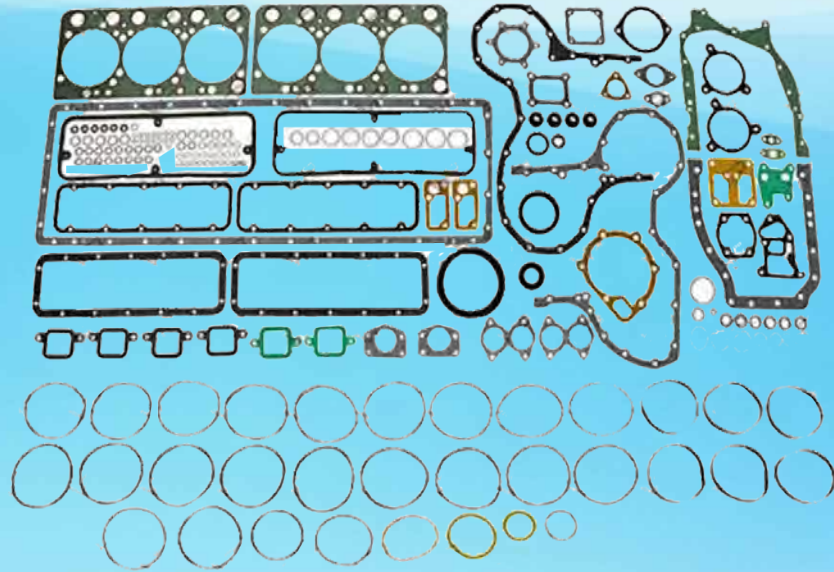

WASHER DETAILS-ORDER BY SIZE		
Description	Qty.	
G3-3512/10,AL-WASHER	5	
14.2X19.8 CUWASHER G3-3512/18 ' 1.4	15	
16.5 X 20 CU WASHER SCANIA ' 1.3	1	
G3-3512/11,AL-WASHER,	1	
20.30 X 25.80 X 1.0 MM ALUMINIUM	1	
G3-3512/21,AL-WASHER	4	
14.3X17.8CUWASHERG3-3512/23 ' 1.3	1	
CU WASHER- 20X9.5 G3-3512/16 ' 1.8	6	
CU WASHER 25.9X20.3 G3-4099/9 ' 1.3	4	
AL WASHER 18.5 X 22.9 X 1.0 MM	3	
15.30 X 18.70 X 1.0 MM ALUMINIUM	1	
AL WASHER 10.1 X 14.9 X 1.0 MM	15	
CU WASHER 11.4X8 G3-3512/8 ' 0.8	15	

O-RING DETAILS-ORDER BY SIZE		
Description	Qty.	
G4-3516 VITON RUB. LIGHT GRN	6	
G4-3555 SEAL ANB 380586801 40.5X56.5X3	1	
G4-3504,O-RING 65X3 ANB 540167701	1	
G4-3503,O-RING,VITON RUB	3	
G4-3502,O-RING,VITON RUB	1	
G4-3501 VITON RUB LIGHT GREEN	2	
G4-3500,O-RING NIT.RUB.	1	
G4-3493,O-RING,NIT.RUB.540166201	1	
G4-3494,O-RING,SILICON RUB	1	
G4-3495,O-RING,SILICON RUB	1	
G4-3496 SIL RUB LEM YELLOW 'O' RING	1	
G4-3497,O-RING,SILICON RUB.	1	
G4-3459 SILI RUBBER BLACK	1	
G4-3499/1,O-RING,NIT.RUB.	1	
G4-3498,O-RING,NITRILE RUB	1	
G4-4548VITON RUB GREEN	18	
G4-4549VITON RUB BLACK	6	
G4-4705SILICON RUB	1	
G4-4556VITON RUB GREEN	1	

SCANIA

TRUSTTEC NO. 06.01.0414

OEM NO. 551 459 APPLICATION DS9, DSC9 CYLINDER 6 CAPACITY 8475 YEAR 1984 ON

OTHER NO. 01-31160-02, 922.323

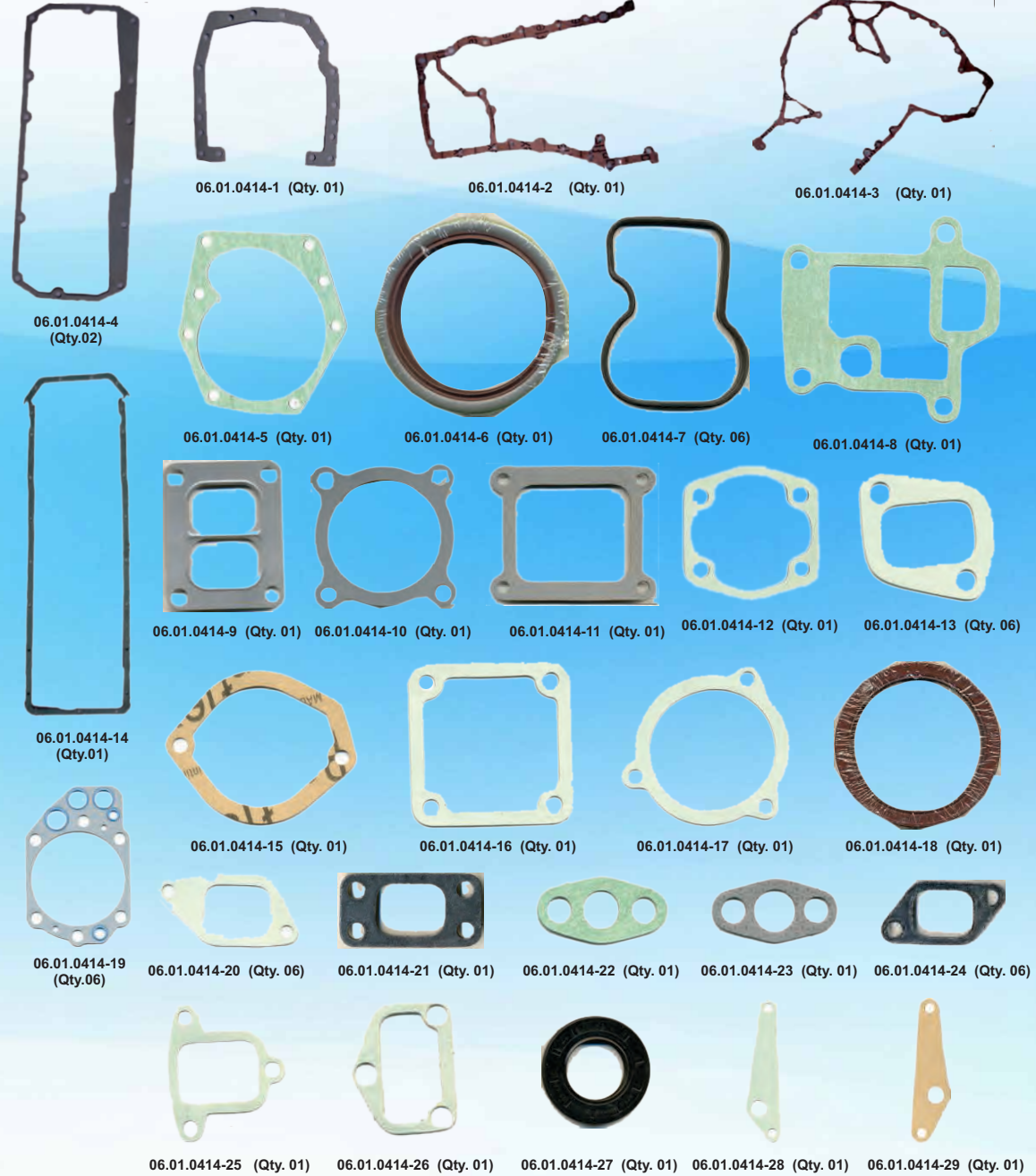
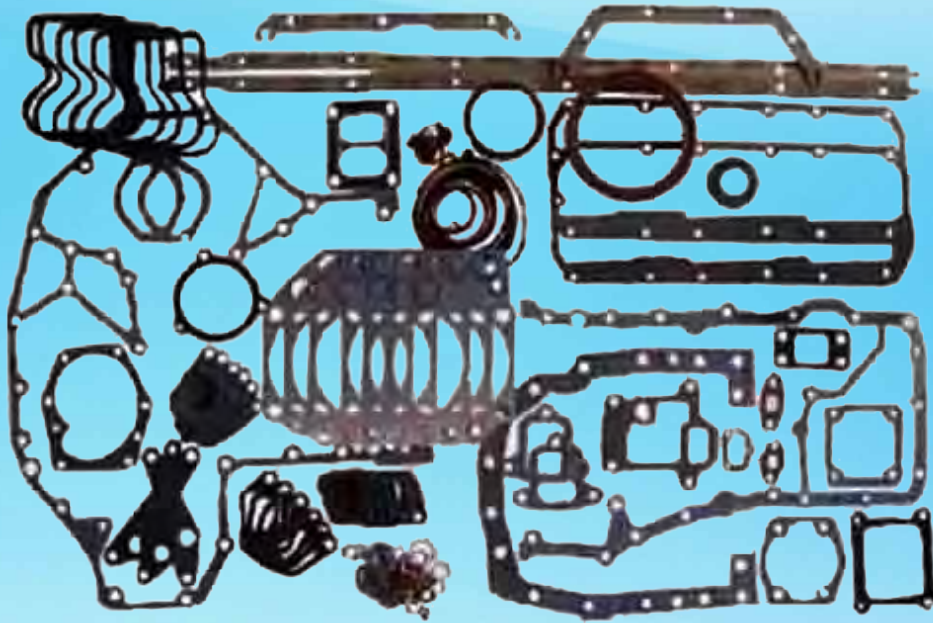

WASHER & O-RING DETAILS-ORDER BY SIZE	
Description	Qty.
G4-3494, O-RING, SILICON RUB	1
G4-3459 SILI RUBBER BLACK	1
O RING G4-3711 ' 3	2
O RING G4-3706 ' 3	2
O RING G4-3713 ' 3	1
O RING G4-3710 ' 3	1
G4-3712 RUBBER GASKET	1
G4-3504, O-RING 65X3 ANB 540167701	2
AL WASHER G4-3743/4 ' 0.8	1
G4-3520 CRCA+NITRILE RUB WASHER	1
G4-3498, O-RING, NITRILE RUB	1
G4-3500, O-RING, NIT. RUB.	1
G4-3725 O RING	6
CU WASHER 10.3X13.3 ' 0.8	5
CU WASHER G4-3743/2 ' 0.8	1
G4-3493, O-RING, NIT. RUB. 540166201	1
G4-3718 O RING	2
G4-3510 SIL RUB BLACK	2

WASHER & O-RING DETAILS-ORDER BY SIZE	
Description	Qty.
G4-3492, O-RING, VITON RUBBER	1
G4-3499/1, O-RING, NIT. RUB.	6
AL WASHER G4-3743/5 ' 1.85	1
CU WASHER G4-3512/4 ' 1.95	1
G3-3580/13AL WAS 22.2X26.8X1.3 38058WM01	1
G3-3512/22, AL-WASHER	2
AL WASHER 18.2X21.9X1.30(G4-3743/5)	1
G3-3512/10, AL-WASHER	5
14.3X17.8CUWASCANIAG3-3512/23 ' 1.3	4
G3-3512/21, AL-WASHER	2
AL WASHER10.3X13.8(G3-3512/15 ' 1.3	3
CU WASHER- 20X9.5 G3-3512/16 ' 1.8	6
14.2X19.8 CUWASHER G3-3512/18 ' 1.4	11
G3-3580/1CU WAS. 8X11.3X0.8 38058WA01	14
G4-3709 ' 5.7	1
G4-3708 ' 6	1
G4-3744 SEAL	1

Suitable for

Cylinder Head Gasket

VOLVO

TRUSTTEC NO. 016.01.0350

OEM NO.

275 740 - 9

OTHER NO.

60-25025-20,
518.301

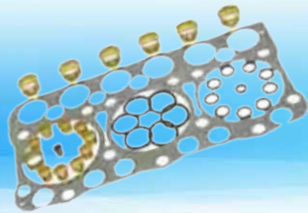

APPLICATION **CYLINDER** **CAPACITY**

D 50, D 60, TD 50, 6 5480
TD 60

TRUSTTEC NO. 016.01.0351

OEM NO.

276 821-6

OTHER NO.

60-31090-10,
754.641

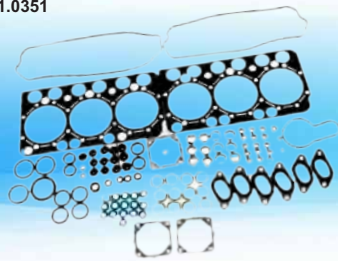

APPLICATION **CYLINDER** **CAPACITY** **YEAR**

TD 61, TD 63 6 5480 1986 ON

TRUSTTEC NO. 016.01.0352

OEM NO.

275 525 - 4

OTHER NO.

60-23155-10,
108.197

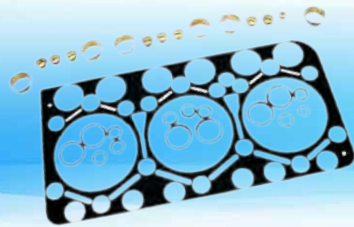

APPLICATION **CYLINDER** **CAPACITY** **YEAR**

D 70, TD 70, 6 6700 1966-1978

TRUSTTEC NO. 016.01.0353

OEM NO.

275 779 - 7

OTHER NO.

60-31095-10,
087.289

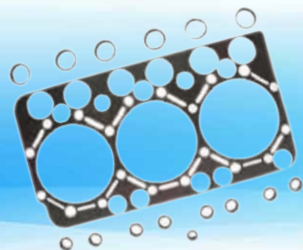

APPLICATION **CYLINDER** **CAPACITY** **YEAR**

TD 71, TD 73 6 6730 1985 ON

Suitable for

Cylinder Head Gasket

VOLVO

TRUSTTEC NO. 016.01.0354

OEM NO.

275 551 - 0

OTHER NO.

60-23160-10,
087.289

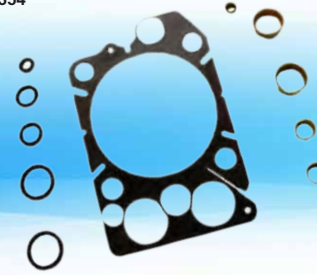

APPLICATION **CYLINDER** **CAPACITY** **YEAR**

D 100, TD 100, 6 9600 1966-1980
HD 100, THD 100

TRUSTTEC NO. 016.01.0355

OEM NO.

270 789 - 1

OTHER NO.

60-27190-10,
755.206



APPLICATION **CYLINDER** **CAPACITY** **YEAR**

TD 100, TD 101,
TD 102, TD 103,
THD 100, THD 101,
THD 102, THD 103

TRUSTTEC NO. 016.01.0356

OEM NO.

275 742 - 5

OTHER NO.

517.046

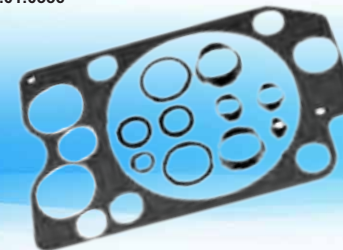

APPLICATION **CYLINDER** **CAPACITY** **YEAR**

D 100, TD 100,
HD 100, THD 100 6 9600 1981 ON

TRUSTTEC NO. 016.01.0357

OEM NO.

270 772 -7
270 949 -1
275 557 -4

OTHER NO.

470.837

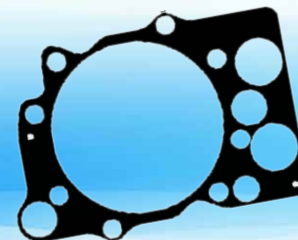

APPLICATION **CYLINDER** **CAPACITY** **YEAR**

F 12, N 12, 6 1996 ON
TD 120

Suitable for **VOLVO** Cylinder Head Gasket

TRUSTTEC NO. 016.01.0358

OEM NO.

275 548 - 6

OTHER NO.

60-23215-10,
087.335



APPLICATION	CYLINDER	CAPACITY	YEAR
TD 120, TD 121,	6	11980	1970 ON

TRUSTTEC NO. 016.01.0359

OEM NO.

270 949 - 1

OTHER NO.

60-31085-10,
755.621

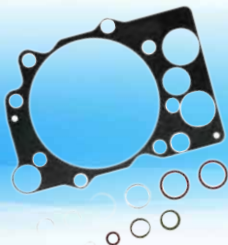

APPLICATION	CYLINDER	CAPACITY	YEAR
TD 122, TD 123	6	11980	1987 ON

TRUSTTEC NO. 016.01.0360

OEM NO.

20 412 953, 20 415 954,
276 887, 276 916,
3 093 503, 3 099 100

OTHER NO.

115.151

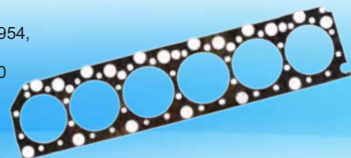

APPLICATION	CYLINDER	CAPACITY	YEAR
D 12A/C/D	6	12100	1993 ON
VOLVO FH 12			

Suitable for **VOLVO** Cylinder Head Gasket

TRUSTTEC NO. 016.01.0361

OEM NO.

20 495 934, 20 495 935,
8 148 046

OTHER NO.

225.100

APPLICATION

Volvo 7700 Bus
Volvo FM 9/260,300, 340, 380
Volvo FM 300, 340, 380
Volvo D 11 - 325, 355, 365, 385, 405
Volvo D9A 260, 300, 340, 380
Volvo D9B 260, 300, 310, 340, 360, 380

CYLINDER CAPACITY YEAR

6 06/2006
6 12.01-09.05
6 09/2005
6 10800
6 9364
6 9364

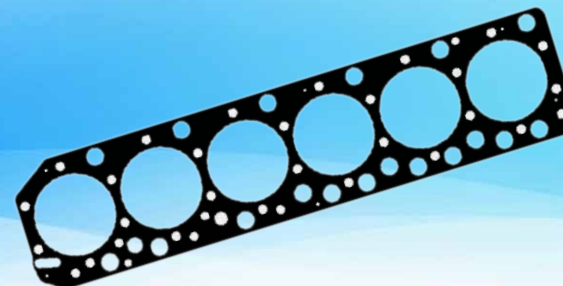

TRUSTTEC NO. 016.01.0362

OEMNO.

20513037
21313537
21510072
7420513037

OTHER NO.

61-36855-00
548.500

APPLICATION

Volvo FH 400, 440, 480
Volvo FM 500, FH 520
Volvo FM 360, 400, 440, 480, 500
Volvo D 13 A - 360, 400, 440, 480, 520
Volvo D 13 B - 360, 400, 440, 500

CYLINDER CAPACITY YEAR

6 09/2005
6 09/2007
6 11/2005
6 12800
6 12800

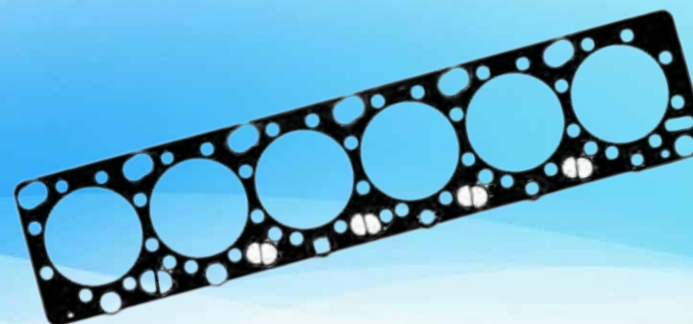

Suitable for

Head Gasket Set

VOLVO

TRUSTTEC NO. 016.01.0363

OEM NO.	APPLICATION	CYLINDER	CAPACITY	YEAR
275 740 - 9	D 50, D 60, TD 50, TD 60	6	5480	1980-1985

OTHER NO.
02-25025-04,
563.413

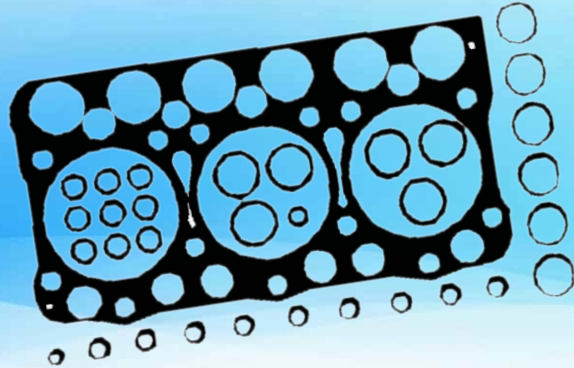

TRUSTTEC NO. 016.01.0364

OEM NO.	APPLICATION	CYLINDER	CAPACITY	YEAR
275 551 - 0	D 100, TD 100, HD 100, THD 100	6	9600	1966-1980

OTHER NO.
02-23160-03,
109.828



Suitable for

Head Gasket Set

VOLVO

TRUSTTEC NO. 016.01.0365

OEM NO.	APPLICATION	CYLINDER	CAPACITY	YEAR
270789-1	TD 100, TD 101, TD 102, TD 103, THD 100, THD 101, THD 102, THD 103	6	9600	1982-1987

OTHER NO.
02-27190-02,
571.220

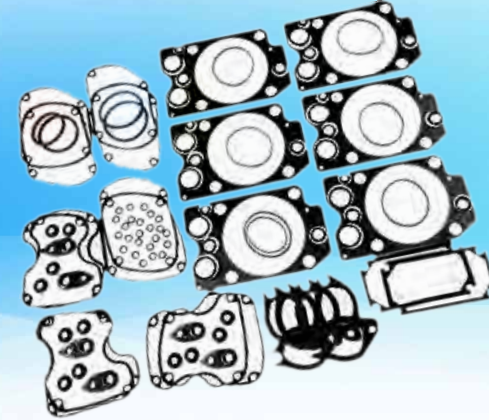

TRUSTTEC NO. 016.01.0366

OEM NO.	APPLICATION	CYLINDER	CAPACITY	YEAR
275 548 - 6	TD 120, TD 121	6	11980	1970 ON

OTHER NO.
02-23215-02,
109.844

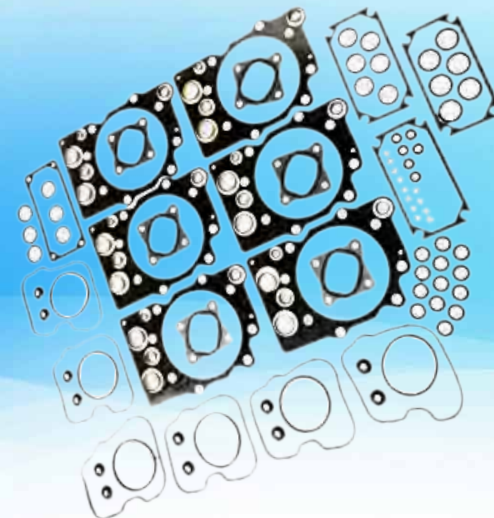

Suitable for

Head Gasket Set

VOLVO

TRUSTTEC NO. 016.01.0367

OEM NO.	APPLICATION	CYLINDER	CAPACITY	YEAR
275 779 - 7	TD 71, TD 73,	6	6730	1985 ON

OTHER NO.

02-31095-01
920.738

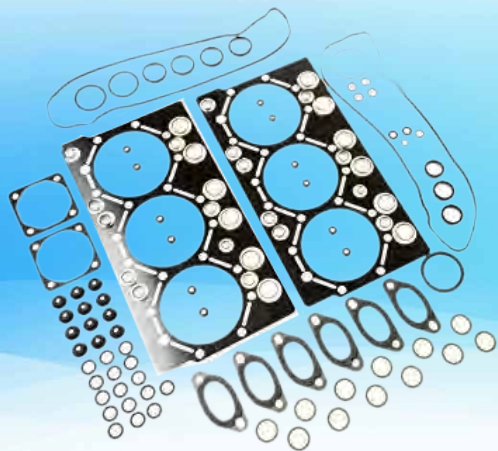

Suitable for

Head Gasket Set

VOLVO

TRUSTTEC NO. 016.01.0369

OEM NO.	APPLICATION	CYLINDER	CAPACITY	YEAR
	TD 122, TD 123,	6	11980	1987 ON

OTHER NO.

02-31085-01
917.109

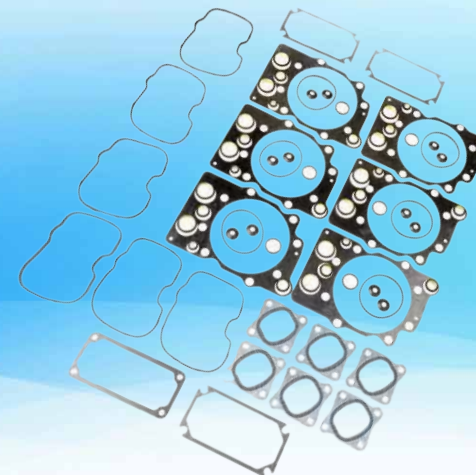

TRUSTTEC NO. 016.01.0368

OEM NO.	APPLICATION	CYLINDER	CAPACITY	YEAR
275 774 - 8	TD 61, TD 63	6	5480	1986 ON

OTHER NO.

02-31090-01,
916.021

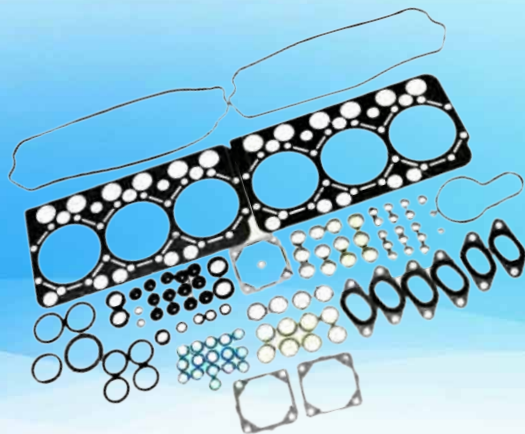

TRUSTTEC NO. 016.01.0370

OEMNO.	APPLICATION	CYLINDER	CAPACITY	YEAR
275 525 - 4	D 70, TD 70	6	6700	1966-1978

OTHER NO.

02-23155-02,
563.499

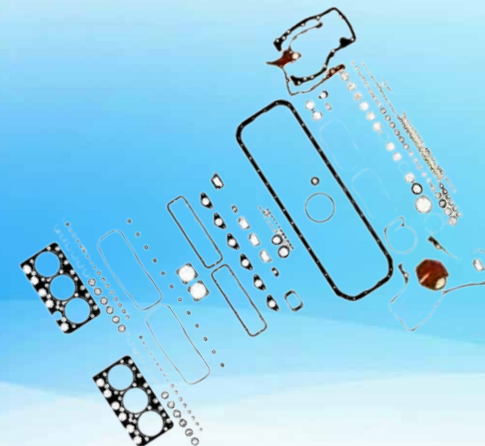

Suitable for

Head Gasket Set

VOLVO

TRUSTTEC NO. 016.01.0371

OEM NO.	APPLICATION	CYLINDER	CAPACITY	YEAR
276 124 - 5	TD 120, TD 121,	6	11980	1970 ON

OTHER NO.
08-24875-03,
108.325



TRUSTTEC NO. 016.01.0372

OEM NO.	APPLICATION	CYLINDER	CAPACITY	YEAR
276 122 - 9	D 100, TD 100 TD 101, TD 102	6	9600	1966-80

OTHER NO.
08-24860-04,
108.295

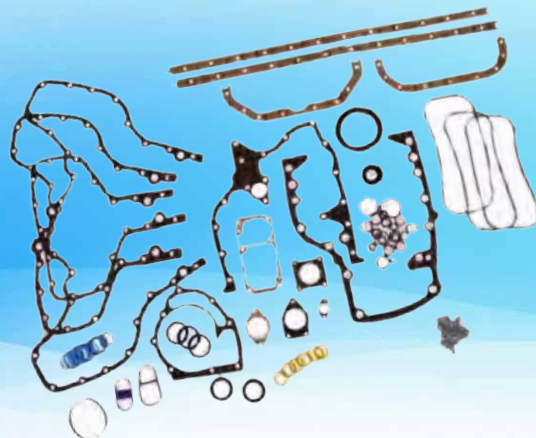

Suitable for

Head Gasket Set

VOLVO

TRUSTTEC NO. 016.01.0373

OEM NO.	APPLICATION	CYLINDER	CAPACITY	YEAR
276 123 - 7	TD 101, TD 102, TD 103	6	9600	1995-98

OTHER NO.
08-24860-05,
755.338



TRUSTTEC NO. 016.01.0374

OEM NO.	APPLICATION	CYLINDER	CAPACITY	YEAR
271 130 - 7 276 125 - 2	TD 122, TD 123	6	11980	1987 ON

OTHER NO.
08-24875-04,
755.648

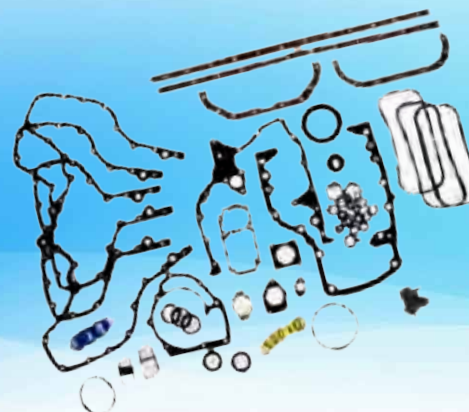

Suitable for

Bottom Gasket Set

VOLVO

TRUSTTEC NO. 016.01.0375

OEM NO.	APPLICATION	CYLINDER	CAPACITY	YEAR
270 775 - 0	TD 71, TD 73	6	6730	1985 ON

OTHER NO.
08-24837-04,
755.540

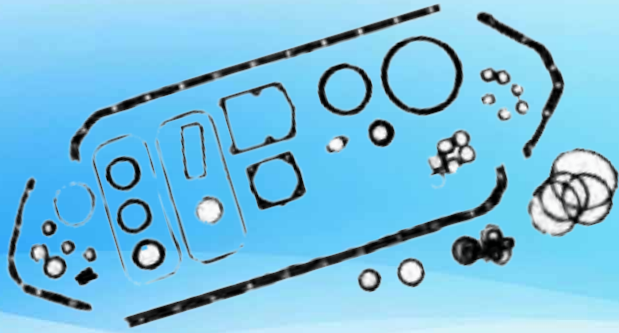

TRUSTTEC NO. 016.01.0376

OEM NO.	APPLICATION	CYLINDER	CAPACITY	YEAR
270 774 - 3	TD 61, TD 63	6	5480	1986 ON

OTHER NO.
08-25034-05,
754.811

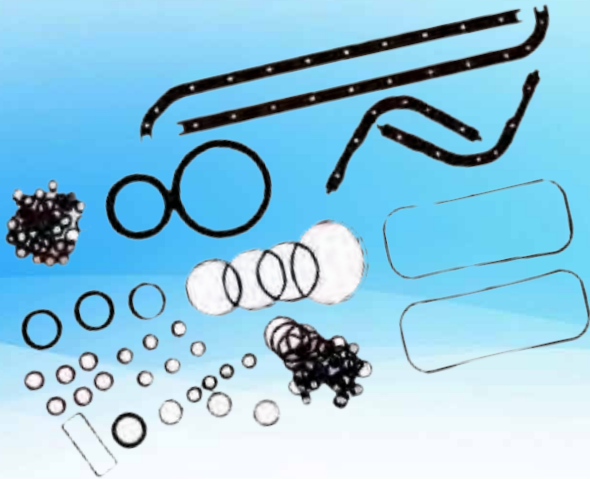

Suitable for

Bottom Gasket Set

VOLVO

TRUSTTEC NO. 016.01.0377

OEM NO.	APPLICATION	CYLINDER	CAPACITY	YEAR
270 277 - 6	D 70, TD 70,	6	6700	1966-1978

OTHER NO.
08-24837-06,
318.826

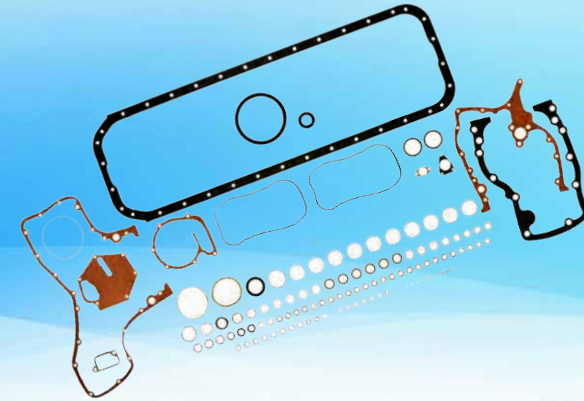

TRUSTTEC NO. 016.01.0378

OEMNO.	APPLICATION	CYLINDER	CAPACITY	YEAR
275548-6	TD120A, TD120C, TD120D, TD120E, TD120F, TD120FC, TD120G, TD120GA, TD121F, TD121FD, TD121FK, TD121G, TD121GA, TD121GD	6	11980	1977-86

OTHER NO.
571.254

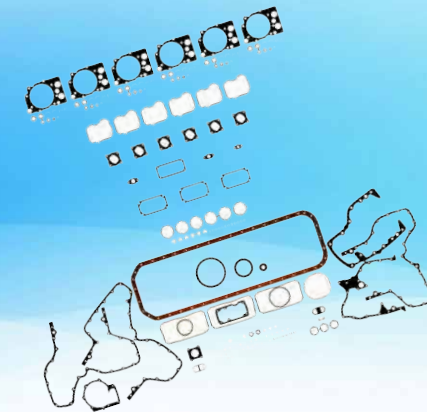

VOLVO

TRUSTTEC NO. 016.01.0379

OEM NO.	APPLICATION	CYLINDER	CAPACITY	YEAR
	D100A, TD100A, D100B, TD100A, TD100B, TD100BG	6	9600	1966-80
OTHER NO.				
563.502 922.323				



016.01.0379-1 (Qty.06)



016.01.0379-2 (Qty. 01)



016.01.0379-3 (Qty. 01)



016.01.0379-4 (Qty. 01)

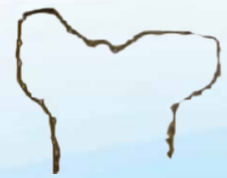

016.01.0379-5 (Qty. 01)

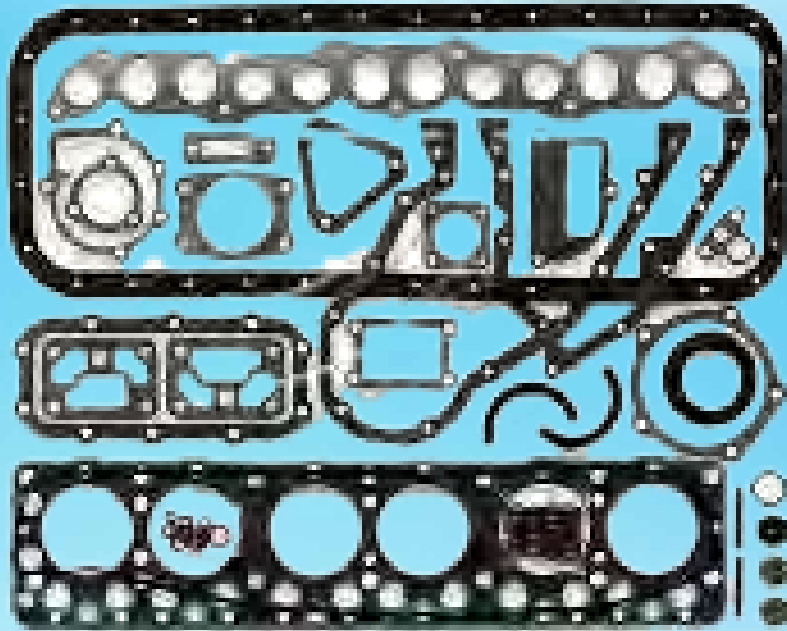

016.01.0379-6 (Qty. 01)



016.01.0379-7 (Qty.01)



016.01.0379-8 (Qty.01)



016.01.0379-9 (Qty.01)



016.01.0379-10 (Qty. 01)



016.01.0379-11 (Qty.01)

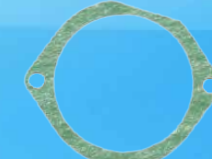

016.01.0379-12 (Qty.01)



016.01.0379-13 (Qty.06)



016.01.0379-14 (Qty.06)



380 54 57 05 (Qty. 01)



380 55 62 01 (Qty. 02)



380 55 66 01 (Qty. 06)



380 55 71 02 (Qty. 01)



G4-4224 (Qty. 01)



016.01.0379-11 (Qty. 01)

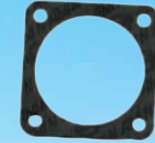

016.01.0379-12 (Qty. 01)



016.01.0379-13 (Qty. 01)



016.01.0379-14 (Qty. 06)



016.01.0379-15 (Qty. 01)



016.01.0379-16 (Qty. 01)



016.01.0379-17 (Qty. 12)



016.01.0379-18 (Qty. 12)



016.01.0379-19 (Qty. 12)



016.01.0379-20 (Qty. 01)



016.01.0379-21 (Qty. 12)



016.01.0379-22 (Qty. 01)



016.01.0379-23 (Qty. 06)



016.01.0379-24 (Qty. 01)



016.01.0379-25 (Qty. 06)



016.01.0379-26 (Qty. 12)



016.01.0379-27 (Qty. 26)



016.01.0379-28 (Qty. 06)



016.01.0379-29 (Qty. 01)

WASHER & O-RING DETAILS-ORDER BY SIZE		
Description	Qty.	
G3-4223 FELT RING 155X167X4.5 380548901	1	
G4-3739 SIL RUB BLK	1	
G4-3491 GASK AVB 380516101 3 MM THK	3	
G4-3738 SEAL ASB 380516601 42X37X3	1	
A-3856 3.5 MM NITRILE BLK (42X35) M.P.	1	
G4-3514/1 TEFLON WASHER BLUE SIZE-	6	
G4-3514/2 TEFLON WAS. BLUE "1.5 540167001	12	
G4-3514/3 TEFLON/WA BLUE 540168201	1	
G4-3593/2 NIT.BLK 50.8X44.8X3 380597702	1	
G4-3748/2 ASR 36.6X28X4.3 380546701	1	
G4-3749/3 SEAL ASB 380544301 37X31X3	6	
G4-3737 SEAL SILICON RUB BLACK	1	
G4-3727 ORING AVB 380617501 32X26X3	2	
G4-3515 VITON RUB BLACK	3	
G4-3738 VITON RUB BLACK	1	
G4-3560 SEAL AVB 380547001 28X22X3	2	
G4-3443 SEAL NITRILE RUB. BLK	1	
G4-3733/2 O-RING AVB 440716201	3	
G4-3504 O-RING 65X3 ANB 540167701	1	
G4-3749/2 SEAL AVB 380544101 51X45X3	1	
G4-4740 POLY.GREEN COL. (MOULDOPG4-3562)	1	
G4-3562 O RING APB 380617501 30X24X3	1	

WASHER & O-RING DETAILS-ORDER BY SIZE		
Description	Qty.	
G4-4558 VITON RUB. BLACK, 380559101	2	
Seal Ring G4-4210 (18x28x7.0)Poly.	1	
G4-3441 SEAL ANB 380596801	6	
G4-4741 VITON PURPLE(MOULDOFG4-3508)	1	
G4-3568 VITON RUB BLK 380568901	1	
G4-3749/1 SEAL AVB 380547101 20X25X3	1	
G4-1421 ASB	1	
G3-3580/12CU WAS. 22.1X28.8X1.3 38058WL01	5	
G3-3580/10CU WAS 19.3X25.8X1.3 38058WJ01	1	
G3-3580/9CU WAS. 18.1X23.8X1.3 38058WV01	3	
CU WASHER 21.8X16.3 G3-4038901	3	
CU WSR 14.1 X 19.9 X 1.50 MM	11	
G4-4252/3 CU WAS. 10.2X16.0X.8 38056WC01	4	
CU WSR 14.1X17.9X1.30 MM G4-3580/4	19	
AL WASHER 12.2X15.4 G3-3512/14 " 1.3	3	
AL WASHER 10X13.3 G4-3763/5 " 0.9	2	
AL WASHER 8.35X11.3 G4-3763/6 " 0.9	15	
G4-4252/1 AL WAS. 21.8X18.4X1.3 38056WA01	1	
G3-3580/5CU WAS 12.1X17.9X1.3 38058WE01	5	
11.20 X 17.80 X 1.35 MM COPPER	2	
G3-3580/1CU WAS. 8X11.3X0.8 38058WA01	3	
G4-4207 ORING 64.7X76.1X5.7 ASR 380566701	1	

Suitable for Decarbonizing Kit

VOLVO

TRUSTTEC NO. 016.01.0383

OEM NO.
270 770 - 1
OTHER NO.
108.074

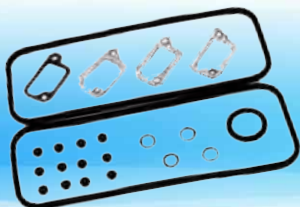

APPLICATION	CYLINDER	CAPACITY
D 50, D 60, TD 50, TD 60	6	5480

TRUSTTEC NO. 016.01.0384

OEM NO.
275 554-4
OTHER NO.
087.343

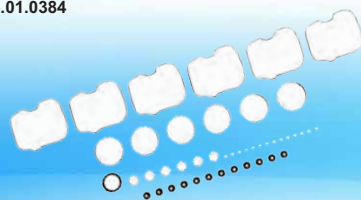

APPLICATION	CYLINDER	CAPACITY
TD 120, TD 121	6	11980

TRUSTTEC NO. 016.01.0385

OEM NO.
276 034 - 6
OTHER NO.
087.299

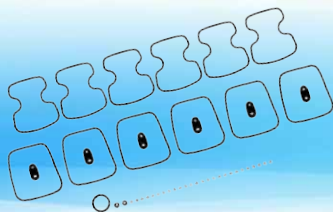

APPLICATION	CYLINDER	CAPACITY
TD 100, TD 101,	6	

TRUSTTEC NO. 016.01.0386

OEM NO.
275 533 - 8
OTHER NO.

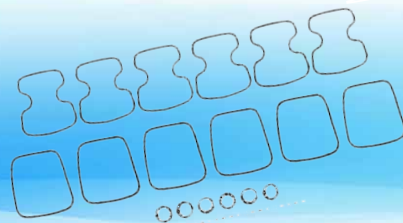

APPLICATION	CYLINDER	CAPACITY
TD 100, TD 101	6	

Suitable for Decarbonizing Kit

VOLVO

TRUSTTEC NO. 016.01.0387

OEM NO.
276 035 - 3
OTHER NO.
563.252

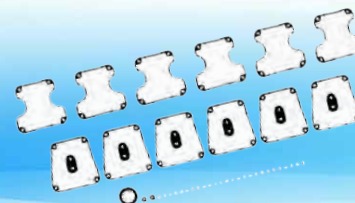

APPLICATION	CYLINDER	CAPACITY
TD 101, TD 102, TD 103	6	9600

TRUSTTEC NO. 016.01.0388

OEM NO.
275 781-3
OTHER NO.

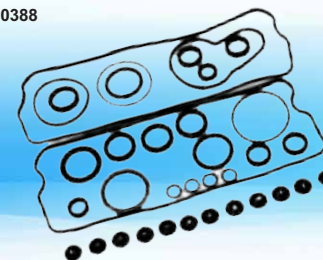

APPLICATION	CYLINDER	CAPACITY
TD 71, TD 73	6	6730

TRUSTTEC NO. 016.01.0389

OEM NO.
275 776 - 3
OTHER NO.
754.927

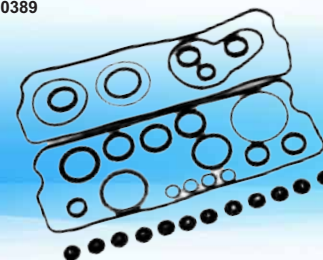

APPLICATION	CYLINDER	CAPACITY
TD 61, TD 63,	6	5480

TRUSTTEC NO. 016.01.0390

OEM NO.
270 761 - 0
OTHER NO.
108.066

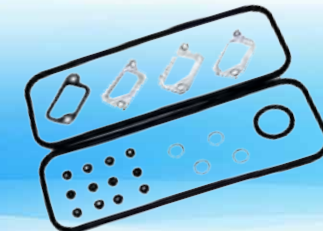

APPLICATION	CYLINDER	CAPACITY
D 70, TD 70	6	6700

Suitable for

Exhaust Manifold

VOLVO

TRUSTTEC NO. 016.01.0391

OEM NO.
470 534 - 9
OTHER NO.
527.319

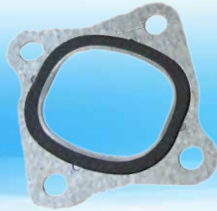

APPLICATION	CYLINDER	CAPACITY
TD 120, TD 121	6	11980

TRUSTTEC NO. 016.01.0392

OEM NO.
424 634-4
OTHER NO.
756.164

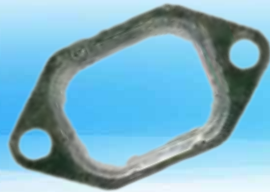

APPLICATION	CYLINDER	CAPACITY
TD 100, TD 101	6	

TRUSTTEC NO. 016.01.0393

OEM NO.
471 650 - 2
OTHER NO.
755.044



APPLICATION	CYLINDER	CAPACITY
TD 71, TD 73,		6730

Suitable for

Exhaust Manifold

VOLVO

TRUSTTEC NO. 016.01.0395

OEM NO.
420 708-0
OTHER NO.

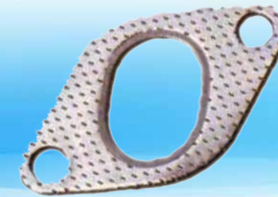

APPLICATION	CYLINDER	CAPACITY
D 50, D 60, TD 50, TD 60	6	5480

TRUSTTEC NO. 016.01.0396

OEM NO.
420 538-1
OTHER NO.



APPLICATION	CYLINDER	CAPACITY
TD 61, TD 63	6	5480

TRUSTTEC NO. 016.01.0397

OEM NO.
479 107-5
OTHER NO.
834.238



APPLICATION	CYLINDER	CAPACITY
TD 101, TD 102, TD 103	6	9600

TRUSTTEC NO. 016.01.0398

OEM NO.
421 534 - 9
OTHER NO.
693.731



APPLICATION	CYLINDER	CAPACITY
TD 101, TD 102, TD 103	6	9600

Suitable for

Intake Manifold

VOLVO

TRUSTTEC NO. 016.01.0399

OEM NO.
424 611-2
OTHER NO.

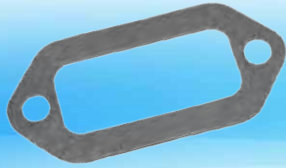

APPLICATION	CYLINDER	CAPACITY
D 50, D 60, TD 50, TD 60	6	5480

Suitable for

Manifold Gasket Kit

VOLVO

TRUSTTEC NO.016.01.0400

OEM NO.
270 769-3
OTHER NO.



APPLICATION	CYLINDER	CAPACITY
D 50, D 60, TD 50, TD 60	6	5480

TRUSTTEC NO. 016.01.0401

OEM NO.
270 768 - 5
OTHER NO.
315.720



APPLICATION	CYLINDER	CAPACITY
D 50, D 60, TD 50, TD 60	6	5480

TRUSTTEC NO. 016.01.0402

OEM NO.
270 772 - 7
OTHER NO.
087.352

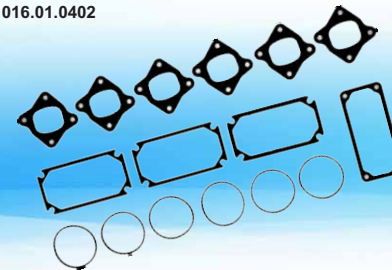

APPLICATION	CYLINDER	CAPACITY
TD 120, TD 121	6	11980

TRUSTTEC NO. 016.01.0403

OEM NO.
270 958 - 2
OTHER NO.
087.301



APPLICATION	CYLINDER	CAPACITY
TD 100, TD 101,	6	

Suitable for

Intake Manifold

VOLVO

TRUSTTEC NO. 016.01.0404

OEM NO.

276 052 - 8

OTHER NO.

563.260

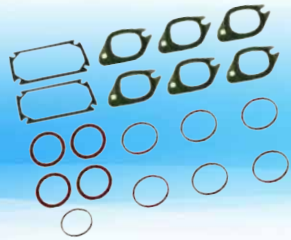

APPLICATION CYLINDER CAPACITY

TD 101, TD 102,
TD 103

6 9600

TRUSTTEC NO. 016.01.0405

OEM NO.

270 765 - 1

OTHER NO.

755.052

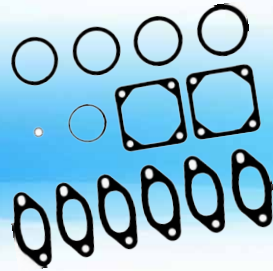

APPLICATION CYLINDER CAPACITY

TD 71, TD 73

6 6730

TRUSTTEC NO. 016.01.0406

OEM NO.

270 764 - 4

OTHER NO.

754.617

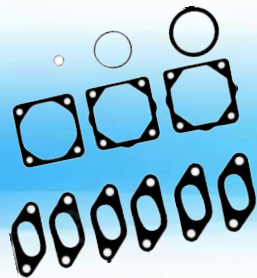

APPLICATION CYLINDER CAPACITY

TD 61, TD 63

6 5480

TRUSTTEC NO. 016.01.0407

OEM NO.

270 771 - 9

OTHER NO.

108.147



APPLICATION CYLINDER CAPACITY

D 70, TD 70,

6 6700

Suitable for

Valve Cover Gasket

VOLVO

TRUSTTEC NO. 016.01.0408

OEM NO.

423 145 - 2

OTHER NO.

088.161



APPLICATION CYLINDER CAPACITY

TD 100, TD 101

6

TRUSTTEC NO. 016.01.0409

OEM NO.

423 146 - 0

OTHER NO.



APPLICATION CYLINDER CAPACITY

TD 100, TD 101

6

TRUSTTEC NO. 016.01.0410

OEM NO.

424 693-0

OTHER NO.

776.476



APPLICATION CYLINDER CAPACITY

TD 101, TD 102,
TD 103

6 9600

TRUSTTEC NO. 016.01.0411

OEM NO.

424 694 - 8

OTHER NO.

776.483



APPLICATION CYLINDER CAPACITY

TD 101, TD 102,
TD 103

6 9600

Suitable for

Valve Cover Gasket

VOLVO

TRUSTTEC NO. 016.01.0412

OEM NO.

424 692 - 2

OTHER NO.

776.468

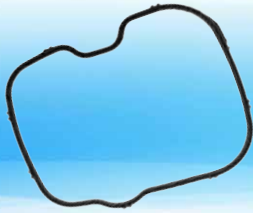

APPLICATION	CYLINDER	CAPACITY
TD 122, TD 123	6	11980

TRUSTTEC NO. 016.01.0413

OEM NO.

471 520 - 7

OTHER NO.

756.504

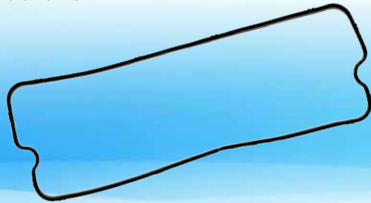

APPLICATION	CYLINDER	CAPACITY
TD 71, TD 73	6	6730

TRUSTTEC NO. 016.01.0414

OEM NO.

421 066 - 2

OTHER NO.

104.213

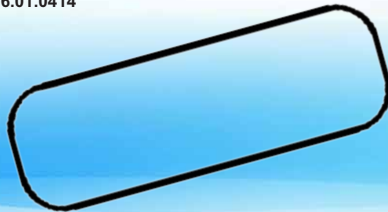

APPLICATION	CYLINDER	CAPACITY
D 70, TD 70,	6	6700

Seal, Coolant Pipe

TRUSTTEC NO. 016.01.0415

OEM NO.

270 771 - 9

OTHER NO.

108.147



APPLICATION	CYLINDER	CAPACITY
TD 100, TD 101	6	