



# HOLDEN-AUSTRALIA

CAPRICE - LUMINA-1999-2011

TRUSTTEC



ARM ASY-LOWER-LH  
1999-2006  
92081620  
07-81620



ARM ASY-LOWER-RH  
1999-2006  
92081621  
07-81621



ARM ASY-LOWER-LH  
2007-2011  
92183309  
07-3309



ARM ASY-LOWER-RH  
2007-2011  
92183310  
07-3310



STB-LINK-KIT-LH  
2006-2006  
92166403  
07-6403



STB-LINK-KIT-RH  
2005-2006  
92166404  
07-6404



STB-LINK-KIT-LH  
2007-2011  
92246135  
07-6135



STB-LINK-KIT-RH  
2007-2011  
92246136  
07-5959



STB-LINK-KIT REAR-LH+RH  
2007-2011  
92195849  
07-5849



STB-LIK-KIT-LH+RH  
2002-2004  
92078631  
07-8631



INNER SHAFT-LH+RH  
1999-2006  
92143047  
07-3047



INNER SHAFT-LH+RH  
2007-2011  
92198273  
07-8273



TIE ROD END OUTER-LH+RH  
1999-2006  
92143049  
07-3049



TIE ROD END OUTER-LH  
2007-2011  
92198274  
07-8274



TIE ROD END OUTER RH  
2007-2011  
92198275  
07-8275



BUSH-CHS-TENSION ROD  
1999-2006  
92047105  
07-7105



BUSH-BIG-CHASSIS-TENSION ROD  
1999-2006  
92039329  
07-9329



BUSH-SMALL-CHASSIS-TENSION ROD  
1999-2006  
9947213  
07-7213



MOUNT-SHOCK  
1999-2011  
92148903  
07-8903



BEARING-MOUNT  
1999-2011  
92046063  
07-6063

Original parts numbers of manufacturers are for comparison only



COUPLING KIT, W/BOLT  
1999-2011  
92143593  
07-3593



COUPLING KIT W/BOLT  
1999-2011  
92143598  
07-3598



BEARING-PROP. SHAFT  
1999-2011  
92143761  
07-3761



BOOT - TIE ROD  
1999-2006  
92146712  
07-6712



INSULATOR-MUFFLER  
1999-2011  
92186996  
07-6996



INSULATOR-STB LINK KIT  
2002-2005  
92159373  
07-9373



BEARING-AXLE-REAR  
1999-2006  
92077119  
07-7119



BEARING-AXLE-REAR  
2007-2011  
92171057  
07-1057



BOOT-AXLE-REAR  
1999-2011  
92148954  
07-8954



ENGINE MOUNT-V8  
2000-2006  
92084910  
07-4910



TRANS-MOUNT  
1999-2011  
92047224  
07-7224



ENGINE-MOL V6-LH  
2004-2010  
92122591  
07-2591



ENGINE-MOL. V6-RH  
2004-2009  
92122590  
07-22590



ENGINE MOUNT-LH+RH-V6  
1999-2003  
22178767  
07-8767

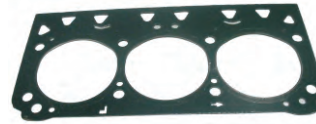

HEAD GASKET V6-LN3  
1999-2004  
24503801  
07-3801

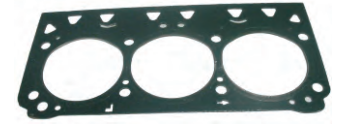

HEAD GASKET V6-LN3  
1999-2004  
24503802  
07-3802

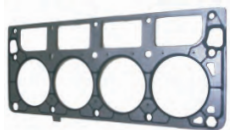

HEAD GASKET-LH V8-LS  
1999-2006  
12558809  
07-8809



HEAD GASKET-RH-V8-LS  
1999-2006  
12558810  
07-8810



BALL JOINT-LOW. ARM L-R  
1999-2006  
92057139  
07-7139



GASKET EXH-MAINFOLD  
2005-2011  
MS95809-1  
07-5809-1

CAPRICE - LUMINA-1999-2011

TRUSTTEC



HOLDEN-AUSTRALIA



GASKET EXH-MANIFOLD  
1999-2011  
MS92467-OEM-12600530  
07-MS92467



GASKET-VALVE COVER-V8  
1999-2011  
12560696  
07-0696

NO PHOTO

GASKET OIL ENG-PAN  
1999-2011  
12568750  
07-8750

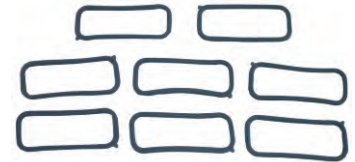

GASKET SET INLET M/F  
1999-2011  
12533587  
07-3587

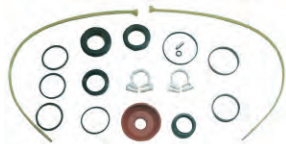

SEAL KIT P/S GEAR  
1999-2006  
92143488  
07-3488



HEAD GASKET-V6  
2005-2011  
12624743  
07-4743



HEAD GASKET-V6  
2005-2011  
12620190  
07-0190



BUSHING SET  
2007-2011  
92159305  
07-9305



BUSHING SET  
2007-2011  
92159311/92224662  
07-4662



MOUNTING  
92057224  
07-7224

CAPRICE - LUMINA-1999-2011

TRUSTTEC®



**BALL JOINT UPPER**  
1980-1994  
45D0016  
07.0016



**BALL JOINT LOWER**  
1980-1994  
45D02026  
07.2026



**BALL JOINT**  
1992-1999  
45D2223  
07.2223



**BALL JOINT**  
2000-2009  
45D0103  
07.0103



**BALL JOINT**  
2000-2009  
45D0104  
07.0104



**TIE ROD-OUTER**  
1980-1994  
45A0184  
07.0184

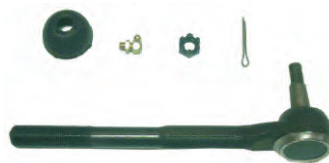

**TIE ROD OUTER**  
1980-1994  
45A0590  
07.0590



**TIR ROD OUT LH-RH**  
2000-2006  
45A0785  
07.0785



**TIE ROD OUTER-LH+RH**  
2007-2011  
45A01092  
07.1092



**INNER SHAFT LH+RH**  
2000-2006  
45A0787  
07.0787



**INNER SHAFT LH+RH**  
2007-2011  
19178561  
07.8561



**INNER SHAFT**  
2002-2011  
45A0888  
07.0888



**STB LINK KIT**  
2002-2009  
45G0254  
07.0254



**STB LINK KIT**  
2002-2009  
45G0255  
07.0255



**STB LINK KIT**  
2002-2009  
45G0467  
07.0467



**STB LINK KIT**  
2002-2009  
45G0468  
07-0468



**STB LINK KIT**  
2002-2009  
45G0252  
07.0252



**STB LINK LIT**  
2002-2009  
45G0253  
07.0253



**TIE ROD END**  
2002-2009  
45A0886  
07.0886



**TIE ROD END**  
2002-2009  
45A0887  
07.0887



STB LINK KIT  
2000-2006  
10385580  
07.5580



MOUNT-TRANS  
1980-1996  
472143  
07.2143



MOUNT-ENGINE  
2000-2006  
25828247  
07.8247



MOUNT-TRANS  
2000-2006  
15677858  
07.7858



MOUNT-ENGINE  
2007-2011  
15854941  
07.4941



DAMPER PULLY  
2000-2006  
12553112  
07.3112

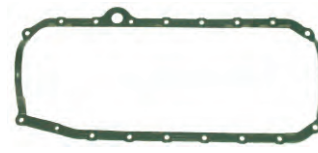

GASKET ENG OIL PAN  
1987-1999  
10108676  
07.8676

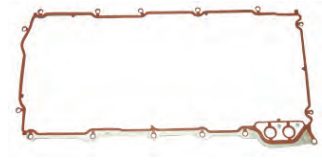

GASKET ENG OIL PAN  
2000-2006  
12580672  
07.0672



GASKET-VALVE COVER  
2000-2011  
12560696  
07.0696

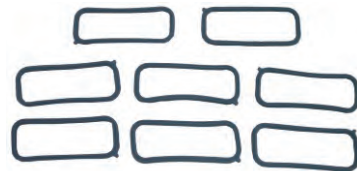

GASKET INLET M/F  
2000-2011  
12533587  
07.3587



GASKET TRANS MT-1  
1992-2011  
8677743  
07.7743



GASKET-DIFF 8.5RG  
1992-1999  
26016661  
07.6661



GASKET -EXH-M/F  
1980-1993  
MS9275  
07.9275



GASKET -EXH-M/F  
1994-1996  
MS95585  
07.5585



GASKET-EXH-M/F  
2000-2006  
MS92211  
07.2211



CABLE-P/BRAKE  
2000-2006  
15226269  
07.6269



CABLE-P/BRAKE LH  
2000-2006  
15087071  
34.15087071



CABLE P/BRAKE RH  
2000-2006  
15087072  
07.7072



OUTLET HEATER WATER  
1992-1999  
15-30900  
07.0900



BUSHES-ARM ASY  
1980-1996  
K6109  
07.6109



**BUSHES-ARM ASY**  
1980-1996  
K6198  
07.6198



**BUSHES-ARM ASY UPPER**  
1992-1992  
K6395  
07.6395



**BUSHES-ARM ASY LOWER**  
1992-1999  
K6327  
07.6327



**BUSHES-ARM ASY UPPER**  
2002-2011  
TBR-7475  
07.7475



**BUSHES-ARM ASY LOWER**  
2002-2011  
TBR-7980  
07.7980



**BEARING**  
1980-1996  
S6  
07.2649



**BEARING**  
1980-1995  
S7  
07.7048



**BEARING**  
1980-1999  
457052  
07-S8



**BEARING**  
1978-1999  
S-20  
07.1503



**BEARING**  
1978-1999  
S-21  
07.1349



**REAR ENGINE OIL SEAL**  
1999-2007  
89060436  
07.0436



**FRONT ENGINE OIL SEAL**  
1999-2007  
12585673  
07.5673



**VALVE COVER GASKET**  
1994-1996  
10046089  
07.6089



**PISTON WITH PIN**  
H840CP  
07.40CP



**SEAL KIT A/C CMPR**  
15-2292  
07.2292



**SEAL KIT**  
15-2720  
07.2720



**SEAL KIT**  
15-2723  
07.2723



**SEAL WASHER KIT**  
2724887  
07.4887



**BUSHING**  
810620  
07.0620



**SPRING**  
7812853  
07.2853

CHEVROLET-CADILLAC-BUICK-HUMMER-OLDSMOBILE-PONTIC

TRUSTTEC



# GENERAL MOTORS



SEAL WASHER KIT  
2724577  
07.4577



GASKET  
12600530  
07.0530



TIE ROD ADJUSTING SLEEVE  
ACD 45A6004/88910750  
07.0750



BEARING KIT FOR DIFF  
07.4041S



DIFF LOCK PIN  
14006401  
07.6401



CON ROD  
12568734  
07.8734



CON ROD  
12569110  
07.9110



VALVE SEAL SET  
SS71043-1  
07.4151S



VALVE SEAL SET INLET  
S-71039  
07.4151S



VALVE SEAL EX  
S-71040  
07.4152EX



VALVE SEAL VS  
1644  
07.4153S



VALVE SEAL 4.6L V8  
2005-2007  
(SET OF 24)  
SS72921-1  
07.2921



VALVE SEAL 5.3L V6  
200-2009  
(SET OF 24)  
SS71237  
07.1237



IDLER ARM  
45C1042/88911296  
07.1296



PITMAN ARM  
45C0069/89000779  
07.0779



IDLER ARM  
45C1120/59000786  
07.1120



PITMAN ARM  
45C0064/88911249  
07.1249



BALL JOINT  
45D2272/89049532  
07.9532



STB BUSH  
15128365  
07.8365

CHEVROLET-CADILLAC-BUICK-HUMMER-OLDSMOBILE-PONTIC

TRUSTTEC

CROWN VICTORIA-GRAND MARQUIS-LINCOLN TOWN CAR-NAVIGATOR-EXPLORER-EXPEDITION

TRUSTTEC



**CLIPS BRAKE PAD**  
1992-1997  
BRPK-5623  
08.5623



**CALIPER BOLT BIG**  
1992-1994  
F4AZ 2B296A  
08.2B296A



**CALIPER BOLT SMALL**  
1995-1997  
F5AZ 2B296A  
08.2B296A

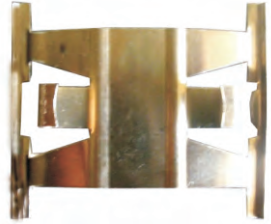

**CLIPS BRAKE PAD**  
1998-2002  
F8VZ 2B164A  
08.2B164AD1



**BOLT CALIPER**  
1998-2002  
F8VZ 2B296A  
08.2B296A



**PARKING BRAKE CABLE**  
1992-2002  
2W7Z 2853BA  
08.2853BA



**PARKING BRAKE CABLE**  
2003-2011  
3W7Z 2853AA  
08.2853AA



**PARKING BRAKE CABLE**  
1998-2002  
2W7Z 2A635DA  
08.2A635DA



**PARKING BRAKE CABLE**  
1998-2002  
2W7Z 2A635GA  
08.2A635GA



**TIE ROD END OUTER**  
1992-2002  
2W7Z 3A130AA  
08.3A130AA



**TIE ROD END OUTER**  
1992-2002  
2W7Z 3A131AA  
08.3A131AA



**SLEEVE TIE ROD END**  
1992-2002  
F7AZ 3310AA  
08.3310AA



**BALL JOINT LOWER**  
F8AZ 3050AA  
08.3050AA



**INNER SHAFT TIE ROD END**  
2003-2011  
3W1Z 3280BA  
08.3280BA



**SHAFT**  
1992-2002  
F8AZ 3B676AA  
08.3B676AA



**"U" JOINT ASTY**  
1995-2002  
F2AZ 4635C  
08.4635C





U-JOINT ASY  
2003-2011  
3W1Z 4635AA  
08.4635AA



INSULATOR MUFFLER  
2003-2011  
3W1Z 5A242AA  
08.5A242AA



PINION SHAFT LOCK  
1989-2011  
E9AZ 4211A  
08.4211A



"U" WASHER PINION  
2003-2011  
C7AZ 4N237A  
08.4N237A



SPIDER PINION KIT  
1989-2011  
5L1Z 4215A  
08.4215A



DIFF BEARING REP KIT  
2003-2011  
XW4Z 4210AAK  
08.4210AAK



STB LINK KIT  
1995-1997  
F6AZ 5K484AA  
08.5K484AA



STB LINK KIT  
1998-2002  
F8AZ 5K484AA  
08.5K484AA



STABILAZER LINK KIT  
2003-2011  
3W1Z 5K484AA  
08.5K484AA



ARM ASY UPPER  
1998-2011  
F8AZ 5500AA  
08.5500AA



ARM ASY LOWER  
1998-2011  
F8AZ 5A649AA  
08.5A649AA



STB LINK ASY REAR  
1998-2011  
6W1Z 4264AA  
08.4264A



INSULATOR MUFFLER  
1992-2002  
F6VZ 5A242AA  
08.5A242AA



GASKET EXH MANIFOLD  
1992-2011  
E9AZ 5E241A  
08.5E241A



STB. BUSH  
6L2Z 5484AA  
08.5484AA



BEARING  
3WW1Z 1225AA  
08.1225AA

CROWN VICTORIA-GRAND MARQUIS-LINCOLN TOWN CAR-NAVIGATOR-EXPLORER-EXPEDITION

TRUSTTEC

CROWN VICTORIA-GRAND MARQUIS-LINCOLN TOWN CAR-NAVIGATOR-EXPLORER-EXPEDITION

TRUSTTEC



INSULATOR COIL SRING  
2003-2011  
5W1Z 5415AA  
08.5415AA

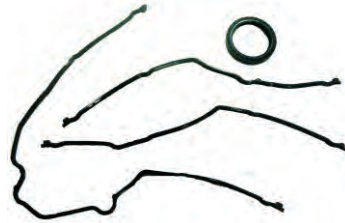

GASKET KIT T/ CASE  
1992-1995  
F1AZ 6020BK  
08.6020BK

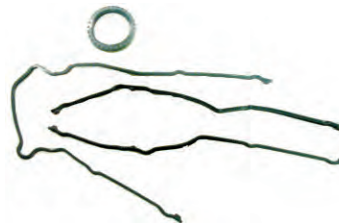

GASKET KIT T/CASE  
1996-2011  
F6AZ 6032A  
08.6032A



ENGINE MOUNT  
1992-1997  
F4AZ-6038-A  
08.6038A



ENGINE MOUNT  
1992-1997  
F4AZ 6038B  
08.6038B

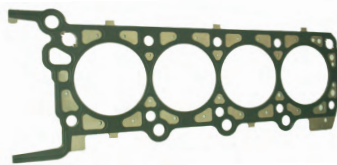

HEAD GASKET 2.2MM  
1992-2011  
4C2Z 6051AA  
08.6051AA



HEAD GASKET 2.2MM  
1992-2011  
4C2Z 6051BA  
08.6051BA



OIL SEAL  
1992-2011  
F5AZ 6700A  
08.6700A



OIL SEAL  
1992-2011  
F4AZ 6701A  
08.6701A



GASKET VALVE COVER  
1992-2001  
F6AZ 6584AA  
08.6584AA



GASKET VALVE COVER  
1992-2001  
F6AZ 6584BA  
08.6584BA



GASKET VALVE COVER  
2002-2011  
2C2Z 6584AA  
08.6584AA



GASKET VALVE COVER  
2002-2011  
2C2Z 6584BA  
08.6584BA



VALVE SEAL  
1992-1995  
F1AZ 6571A  
08.6571A



VALVE SEAL 4.6LT  
1996-2011  
F6AZ 6571AA  
08.6571AA



VALVE SEAL 4.6LT  
2003-2011  
F4AZ 6571AA  
08.6571AA



DAMPER PULLEY 5.0LT  
1989-1991  
E4TZ 6316A  
08.6316A



DAMPER PULLEY 4.6LT  
1992-2000  
F3AZ 6316A  
08.6316A



DAMPER PULLEY  
2001-2011  
1W7Z 6312AA  
08.6312AA



HYDRAULIC LIFTER PIPE  
1992-2011  
F6DZ 6C501A-HL7000S  
08.6C501A



HYDRAULIC TENSIONER  
1992-2011  
6L266BA  
08.6L266BA



HYDRAULIC TENSIONER  
1992-2011  
F6AZ 6L266DA  
08.6L266DA

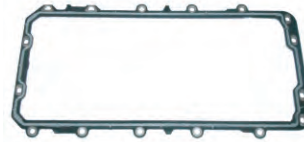

GASKET OIL PAN  
1992-2009  
3L3Z 6710AA  
08.6710AA



OIL ADAPTOR  
1992-2011  
9W1Z 6881C / F1AZ 6881BA  
08.6881C

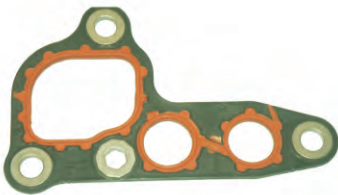

GASKET OIL ADAPTOR  
1992-2002  
F6AZ 6840AA  
08.6840AA

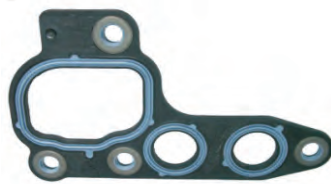

OIL ADAPTOR GASKET  
2003-2011  
F6AZ 6840BA  
08.6840BA

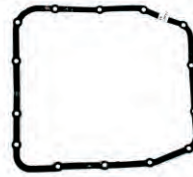

GASKET TRANS OIL PAN  
1992-2011  
F2VY 7A191AA  
08.7A191AA



GASKET TRANS OIL PUMP  
1992-2011  
F2VY 7A136A  
08.7A136A

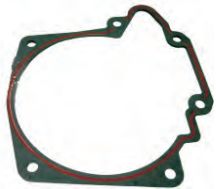

GASKET TRANS HOUSING  
1992-2011  
F7AZ 7086A  
08.7086



VALVE GUIDE  
1992-1994  
VG-1389T  
08.1389T



VALVE GUIDE  
1995-2002  
VG 8680  
08.8680



BUSHING KIT  
1995-2002  
K8703  
08.K8703

CROWN VICTORIA-GRAND MARQUIS-LINCOLN TOWN CAR-NAVIGATOR-EXPLORER-EXPEDITION

TRUSTTEC



BUSHING KIT  
1998-2002  
K80029  
08.K80029



BUSHING KIT  
1995-1997  
K8297  
08.K8297



BUSH UPPER ARM ASY  
2003-2011  
K8706  
08.K8706



BUSHES UPPER ASY  
2002-2005  
6L1Z 3084AAA(K8707)  
08.8707

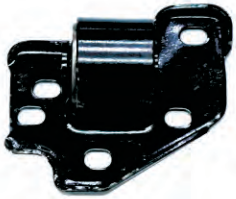

BUSHES UPPER ASY  
2002-2005  
6L2Z 3084AA(K8708)  
08.8708



GASKET INLET MANIFOLD  
1995-2001  
XW7Z 9439AA  
08.9439AA



GASKET INLET MANIFOLD  
2002-2011  
YL3Z 9439BA  
08.9439BA



EXHAUST M/F GASKET  
1996-2009  
F5AZ 9448A  
08.9448A

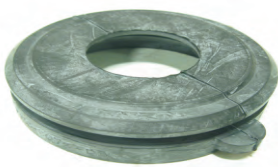

SAEL FUEL TANK  
1992-1997  
F4ZZ 9072A  
08.9072A

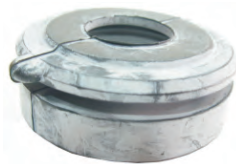

SEAL FUEL TANK  
2003-2011  
2R3Z 9072AA  
08.9072AA



SEAL FUEL TANK  
2003-2011  
9W1Z 9072A  
08.9072A



P/B REPAIR KIT  
1998-2002  
H7001  
08.H7001



P/B REPAIR KIT  
1992-1997  
H7002  
08.H7002



P/B REPAIR KIT  
2003-2011  
H7003  
08.H7003



WATER OUTLET  
1992-1994  
RH-100  
08.RH100



WATER OUTLET  
1995-2000  
RH-126  
08.RH126

CROWN VICTORIA-GRAND MARQUIS-LINCOLN TOWN CAR-NAVIGATOR-EXPLORER-EXPEDITION

TRUSTTEC



NIPPLE HEATER PIPE  
1997-2011  
F75Z8555AA  
08.8555AA



HEATER PIPE  
1998-2000  
F8AZ 18B402BA  
08.18B402BA



HEATER PIPE  
2001-2002  
1W7Z18663AA  
08.18663AA



HEATER PIPE  
2003 -2011  
9W1Z 18663A  
08.18663A



TIE ROD END  
2003-2011  
3W1Z 3A130BB/BA  
083A130BB/BA



"O" RING  
1996-2009  
RG 571 FIVY 8255A  
08.RG 571



STAR GASKET  
F6ZZ 9L467 B  
08.9L467B



PLUG W/GASKET  
F75Z 6730BA  
08.6730BA



GASKET T/C  
1992-2009  
F1AZ 6020A  
08.6020A



GASKET T/C  
1992-2009  
F1AZ 6020B  
08.6020B



GASKET T/C  
1992-2009  
F1AZ-6020BB  
08.6020BB



GASKET T/C  
1992-2009  
F1AZ 6020C  
08.6020-C



SEAL  
F7AZ 7052A  
08.7052A



BOLT  
FOVY 1107A  
08.1107A



NUT  
6W7Z 1012BA  
08.1012BA



FUEL INJECTION RING  
1996-2009  
CM 4717  
08.CM 4717

CROWN VICTORIA-GRAND MARQUIS-LINCOLN TOWN CAR-NAVIGATOR-EXPLORER-EXPEDITION

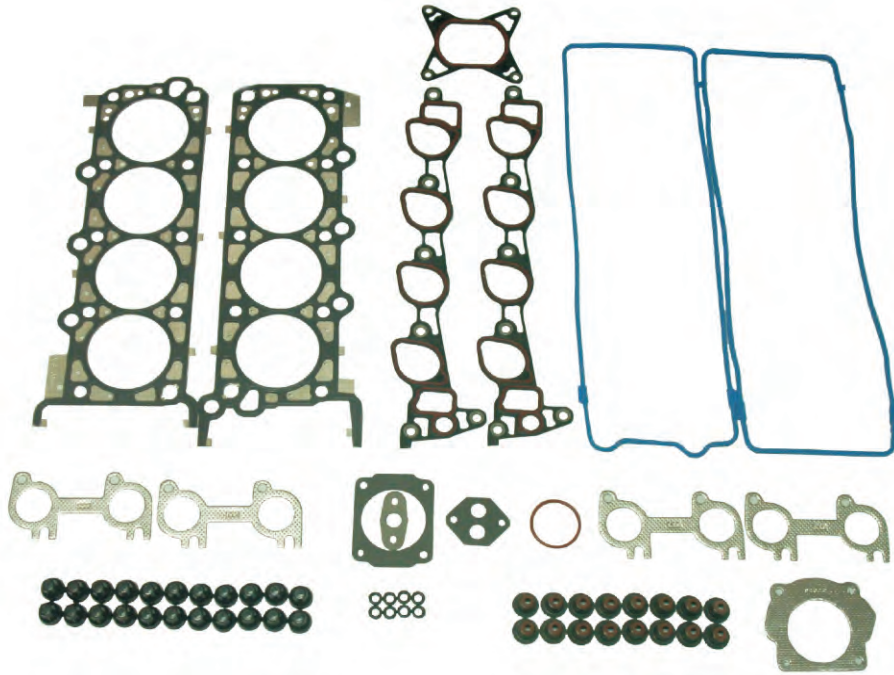

**GASKET SET UPPER  
1996-2000-4.6LT-ENG  
F6AZ 6079DA  
08.6079DA**

**TRUSTTEC**

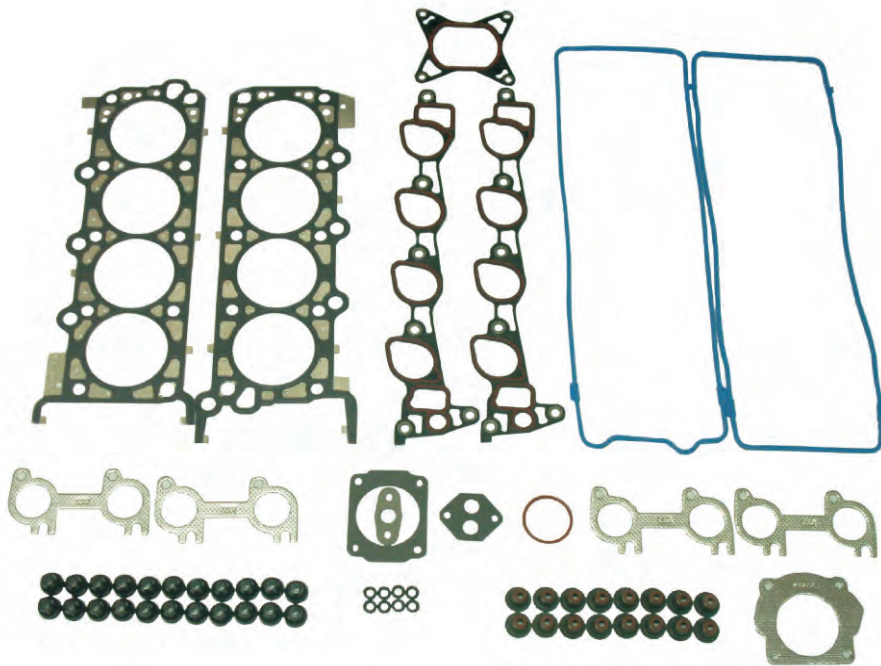

**GASKET SET UPPER  
2001-2002-4.6LT-ENG  
2L3Z 6079A  
08.6079A**

CROWN VICTORIA-GRAND MARQUIS-LINCOLN TOWN CAR-NAVIGATOR-EXPLORER-EXPEDITION

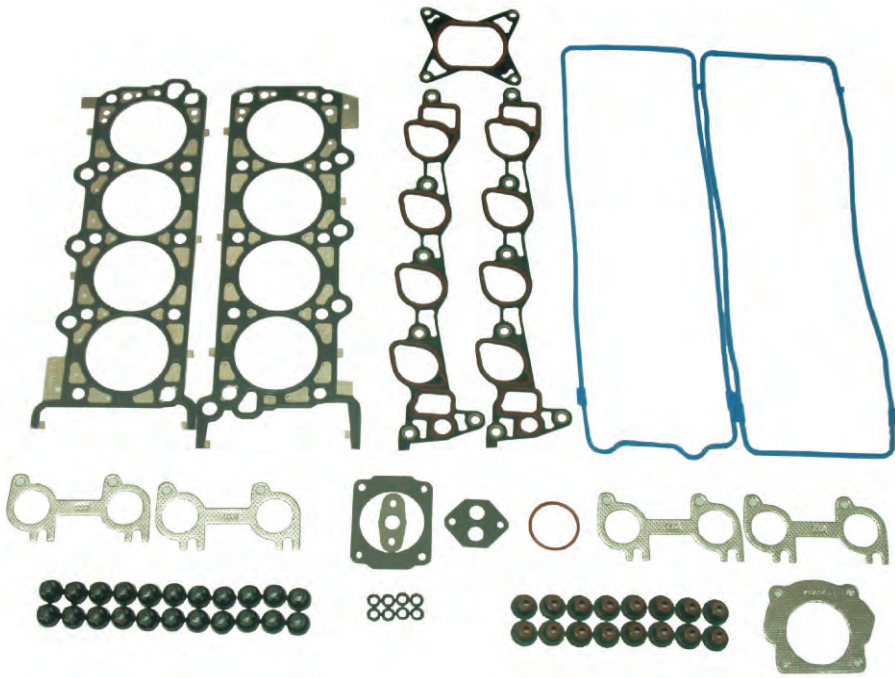

**GASKET SET UPPER**  
**2003-2009-4.6LT-ENG**  
**3W7Z 6079AA**  
**08.6079AA**

TRUSTTEC®

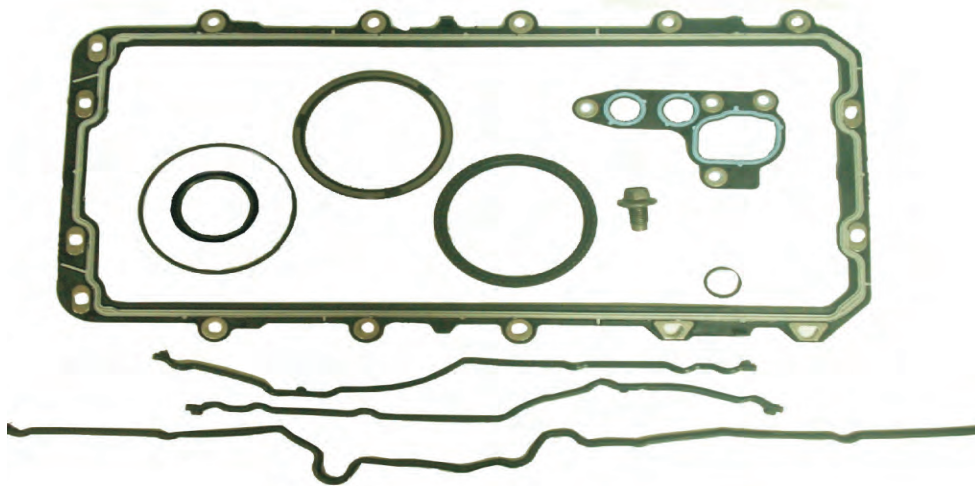

**GASKET SET LOWER**  
**1992-2011-4.6LT-ENGINE**  
**3W7Z 6E078A**  
**08.6E078A**



NUT  
6C2Z 1012AA  
08.1012AA



BOLT  
F5AZ 1107A  
08.1107A



PISTON  
H591CP  
08.H591CP



BUMPER  
390096-S100  
08.S100



SEAL KIT  
F7AZ 3E502AA  
08.3E502AA



SEAL KIT  
F7AZ 3E501AA  
08.3E501AA



INSULATOR  
F8AZ 5493AA  
08.5493AA



SEAL KIT  
F3AZ 3E502A  
08.3E502A



SEAL KIT  
D7AZ 3E501B  
08.3E501B



ENGINE VALVE  
I-2388/E-2421  
08.-2424S



A/C SEAL KIT YE-57  
F1VY-19D665-A  
08.19D665-A

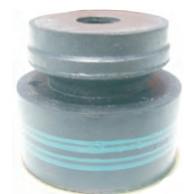

BODY MOUNT  
F5VZ-5400396A  
08.0396A



6W1Z 5400396B  
F8VZ 5400155ZZ  
08.0396B



BOLT  
W709224-S439  
08.S439



BOLT  
W704883 SS436  
08.SS436



GASKET  
1L2Z 9461CA  
08.9461CA

CROWN VICTORIA-GRAND MARQUIS-LINCOLN TOWN CAR-NAVIGATOR-EXPLORER-EXPEDITION

TRUSTTEC



**OVERHAUL GASKET & OIL SEAL KIT  
F8AZ-7153-AC  
08.F8AZ-7153-AC  
CONSISTING OF.:**

CROWN VICTORIA-GRAND MARQUIS-LINCOLN TOWN CAR-NAVIGATOR-EXPLORER-EXPEDITION

TRUSTTEC®

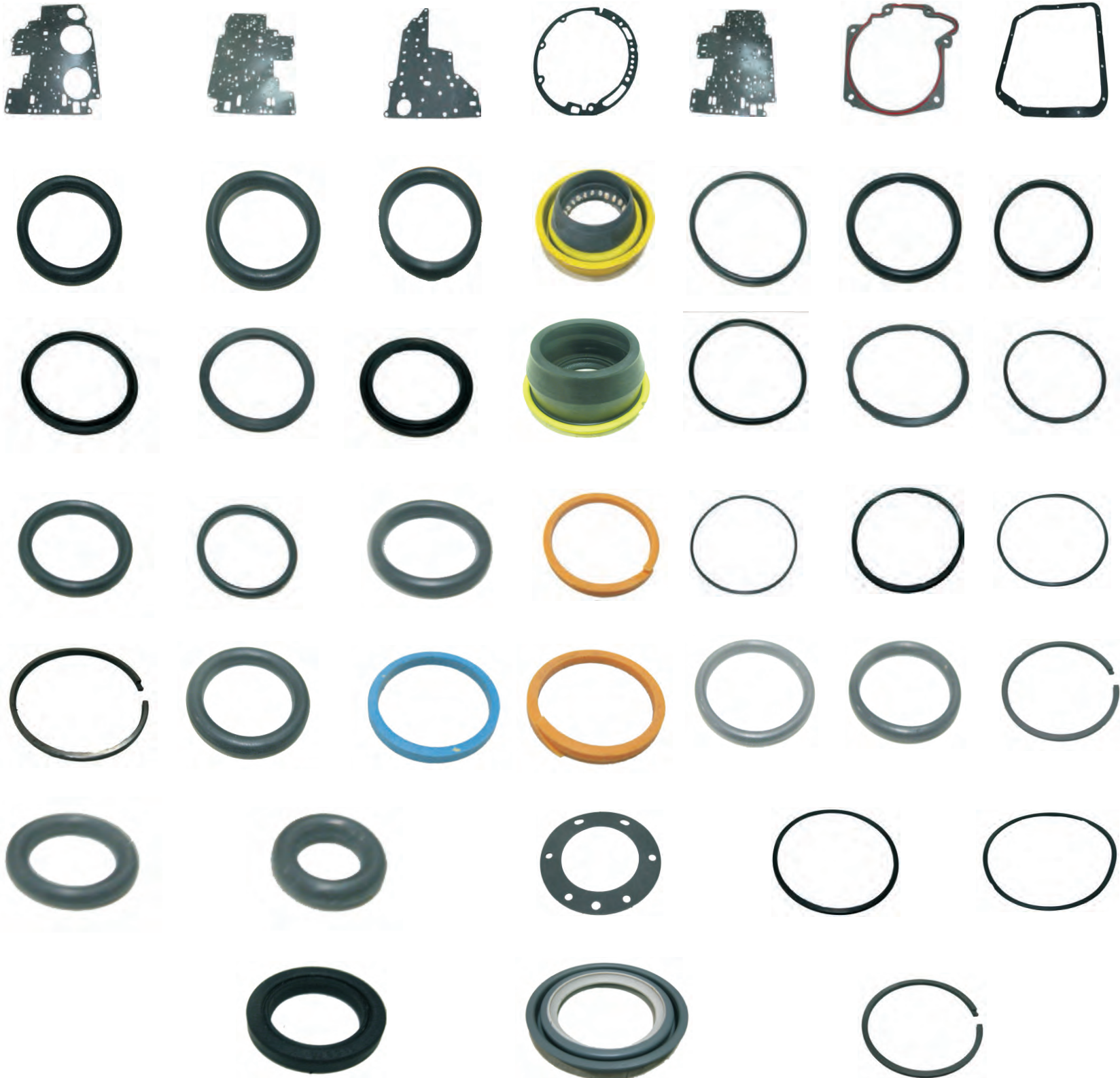

**GASKET & SEAL KIT  
DXFIOD-PRS  
AOD(FIOD)  
08.DXFIOD-PRS  
CONSISTING OF.:**

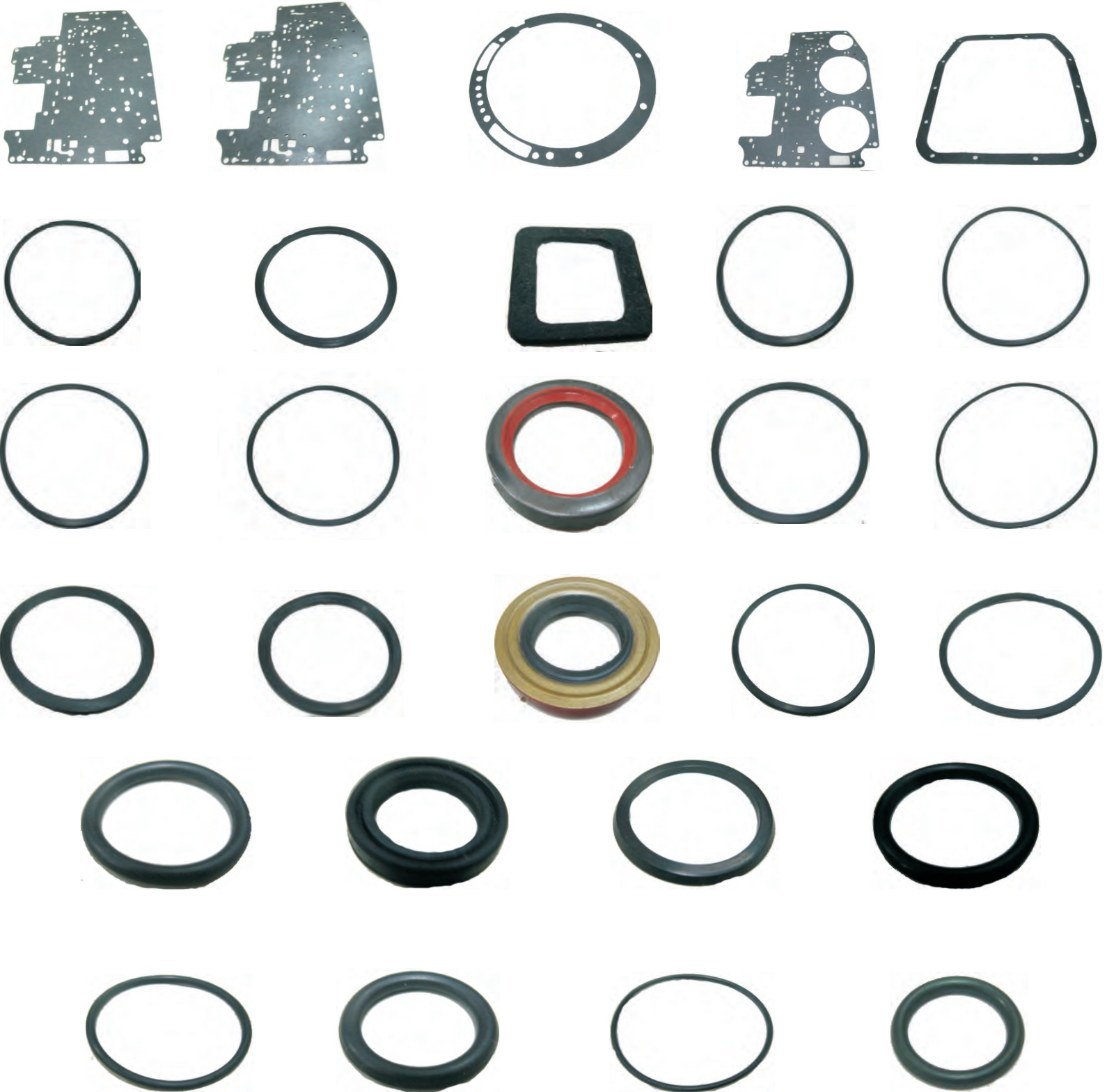

CROWN VICTORIA-GRAND MARQUIS-LINCOLN TOWN CAR-NAVIGATOR-EXPLORER-EXPEDITION

TRUSTTEC®

**GASKET & SEAL KIT**  
**1992-1995**  
**DXAODE-PRS**  
**AODE,AODE-W(4R70W)**  
**08.DXAODE-PRS**  
**CONSISTING OF.:**

CROWN VICTORIA-GRAND MARQUIS-LINCOLN TOWN CAR-NAVIGATOR-EXPLORER-EXPEDITION

TRUSTTEC

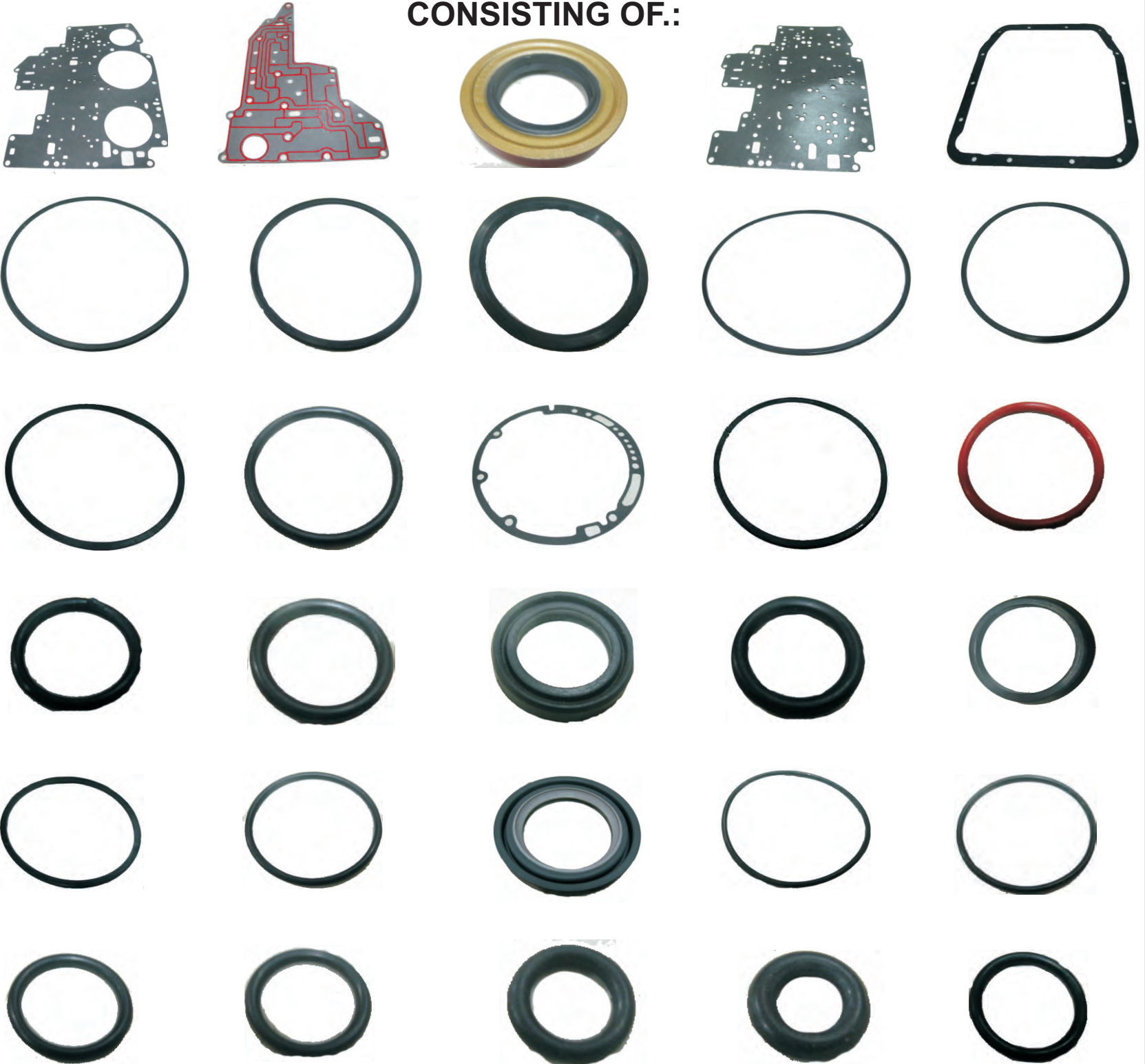

**GASKET & SEAL KIT  
1996-2002  
DX4R70W-PRS  
AODE-W (4R70W)  
08.DX4R70W-PRS  
CONSISTING OF.:**

CROWN VICTORIA-GRAND MARQUIS-LINCOLN TOWN CAR-NAVIGATOR-EXPLORER-EXPEDITION

TRUSTTEC

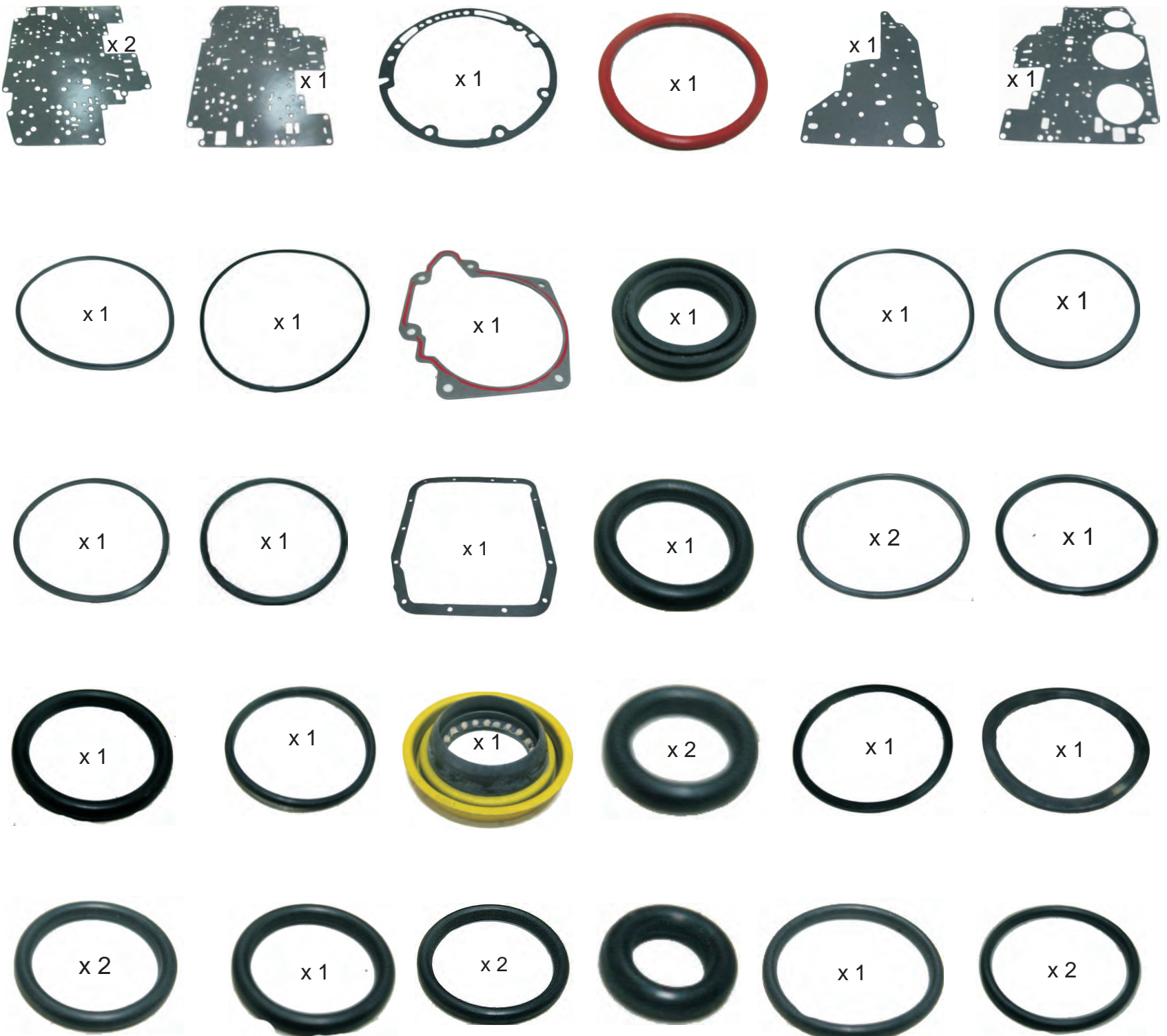



IDLER ARM  
1W1Z3355AA  
08.3355AA



TIE ROD END  
F5AZ 3V130A  
08.3V130A



TIE ROD END  
F5AZ 3V131A  
08.3V131A



PITMAN ARM  
4U2Z 3V590AA/  
MCS 190143  
08.3V59AA



BALL JOINT  
F2AZ 3V049AA/  
MCS 10422S  
08.3V049AA



BALL JOINT  
F4ZZ 3V050A/  
MCS104226  
08.3V050A



POWER STG. HOSE  
2003-2010  
1W7Z 3A719AA  
08. 3A719AA



POWER STG. HOSE  
6W1Z 3A719A  
08.3A719A



POWER STG. HOSE  
F5AZ 3A719A  
08.3A719A

CROWN VICTORIA-GRAND MARQUIS-LINCOLN TOWN CAR-NAVIGATOR-EXPLORER-EXPEDITION

TRUSTTEC®