

AMERICAN APPLICATIONS - CATALOGUE 2019

TRUSTTEC®







QUALITÄT ERSATZTEILE





TRUSTTEC® GENUINE
Trust Tec Original Spare Parts
www.trusttec.eu

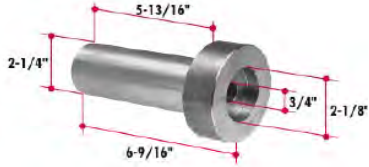



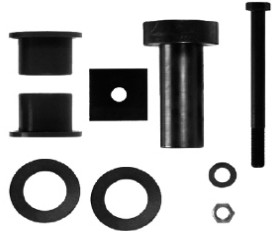
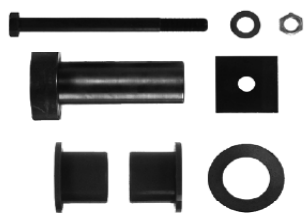

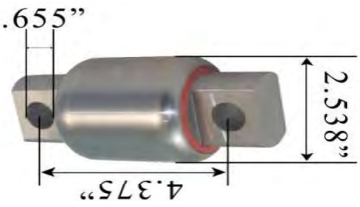







Quality Through Research



ISO : 9001 : 2015



| | | | | | |
|----|--|---|----|--|--|
| 1) | <p>043-01-0001</p>  | <p>RUBBER LOAD SPRING CHARMER, FREIGHTLINER,15002</p> | 2) | <p>043-01-0002</p>  | <p>EQUALISER 681-325-01-27 FREIGHTLINER Automann EQ011</p> |
| 3) | <p>043-01-0003</p>  | <p>EQUALISER 681-325-04-27 FREIGHTLINER Automann EQ012</p> | 4) | <p>043-01-0004</p>  | <p>EQUALIZER BUSH,FREIGHTLINER Freightliner 1613568000, Freightliner A16-13570-000 Freightliner A16-10549-000, Id:2.250, Od1:2.750, Od2:3.750, L1:2.750, TRB5906</p> |
| 5) | <p>043-01-0005</p>  | <p>CAP & TUBE ASSY, EQUALIZER TRS4017 Freightliner 16-14643-000 Freightliner 1614643000, Freightliner A1612591000</p> | 6) | <p>043-01-0006</p>  | <p>CAP & TUBE ASSY, EQUALIZER TRS4015 Freightliner A16-10550, Freightliner A16-10550-000</p> |



| | | | | | |
|-----|---|---|-----|--|--|
| 7) | <p>043-01-0007</p>  | <p>EQUALIZER BUSH,FREIGHTLINER TRK5900</p> | 8) | <p>043-1-0008</p>  | <p>EQUALIZER BUSH KIT Freightliner A16-12591-000 TRK5906</p> |
| 8) | <p>043-01-0009</p>  | <p>TORQUE ARM BUSH,PU Meritor R303294 MERRITOR</p> | 9) | <p>043-01-0010</p>  | <p>TORQUE ARM BUSH CTC:5.672", Hole dia:0.813" Bush W:2.50" Freightliner:16-16412-00, 16-18035-00,16-139262-000 Hendrickson:52296 Iunternational:3538115C1 Kenworth:52296-AG400L Peterbilt:52296 Meritor:R308804 #MR 782/MR656</p> |
| 10) | <p>043.-01-0011</p>  | <p>Torque rod bush VOLVO 35033-0008 / 35033-3201 / 8079894 , FREIGHTLINER 151087-148 HENDRICSON 44694, MACK:1688-227710 3249322R1 / 1693060C1 Meritor R302225/R307638 Peterbilt:02-27710 #TRB 6164 / #TRB 164 od:2 17/32", Bolt hole:5/8"</p> | 11) | <p>043-01-0012</p>  | <p>Torque rod bush Freightliner IPC-233291, Leland SA1164 Freightliner 151087-148 TRB6164</p> |

| | | | | | |
|-----|--|---|-----|--|--|
| 12) | <p>043-01-0013</p>  | <p>TORQUE ROD Freightliner 16-09864-000, Freightliner 16-10420-1 Freightliner 16-11275-0, Freightliner B16-10420-1, Freightliner B16-10420-001, Freightliner B1610420001, Freightliner IPC-927180, IPC927180, TMR 513</p> | 13) | <p>043-01-0014</p>  | <p>TORQUE ROD 22.89" Rigid Torque Rod Comes with Two (2) 321-223 Straddle Mount Bushing. Requires 5/8" Diameter Bolts in Bushings. Freightliner 681-326-63-16, Freightliner 6813266316, TMR515</p> |
| 14) | <p>043-01-0015</p>  | <p>TORQUE ROD Freightliner 16-13498-000 Freightliner 1613053000 TMR 516</p> | 15) | <p>043-01-016</p>  | <p>TORQUE ROD Freightliner 1613054000 Freightliner 6813266216, Freightliner 1613504000 MERITOR R309869 TMR3054</p> |
| 16) | <p>043-01-0017</p>  | <p>TORQUE ROD Freightliner:16-16749-002/ 16-16792-000//681-326-72-16 TR030010040 CTC:24.3125,Bolt CTC:4.375",Bolt hole:0.6875" #TMR 535</p> | 17) | <p>043-01-0018</p>  | <p>TORQUE ROD Heavy Duty,with reinforced 45mm Rod Freightliner:16-16749-002/ 16-16792-000//681-326-72-16 TR030010040 hole:0.6875" #TMR 535</p> |

| | | | | | |
|-----|--|---|-----|--|--|
| 18) | <p>043-01-0019</p>  | <p>TORQUE ROD, RIGID A16-16749-001 Dayton 345-915 CTC:23.8125", Bolt CTC:4.375", Bolt hole:0.6875" #TMR 514</p> | 19) | <p>043-01-0020</p>  | <p>SHAFT TORQUE ARM FREIGHTLINER 169848 MERRITOR R303295</p> |
| 20) | <p>043-01-0021</p>  | <p>REAR HANGER Freightliner 16-09516-000 Freightliner 16-9516, Freightliner 16-09985-003 Freightliner 1609985-001 Freightliner 16-9985- M1062</p> | 21) | <p>043-01-0022</p>  | <p>SPRING HANGER BRACKET Freightliner A1612314000 M1480</p> |
| 22) | <p>043-01-0023</p>  | <p>HANGER WEAR PAD Freightliner 6813252109 Freightliner 1616456000 Meritor R308802 MFL104</p> | 23) | <p>043-01-0024</p>  | <p>HANGER WEAR PAD Freightliner 6813252209 Freightliner 6813252210 Freightliner 16164560001 Meritor R308803 MFL106</p> |

| | | | | | |
|-----|--|--|-----|--|--|
| 24) | <p>043-01-0025</p>  | <p>Tie Rod Assy with ends 58.75" Tie Rod Assy with ends 59.75" Tie Rod Assy with ends 60.75" Tie Rod Assy with ends 61.75" Tie Rod Bar without Tie Rod Ends FREIGHTLINER 58.75" Tie Rod Bar without Tie Rod Ends FREIGHTLINER 59.75" Tie Rod Bar without Tie Rod Ends FREIGHTLINER 60.75" Tie Rod Bar without Tie Rod Ends FREIGHTLINER 61.75" Tie Rod End Freightliner 5.44" Tie Rod End Freightliner 6.00"</p> | 25) | <p>043-01-0026</p>  | <p>Drag link ,Freightliner Freightliner 1417303000 Freightliner 1415491000 463,DS4695 L:18.500",7/8"-14THRD</p> |
|-----|--|--|-----|--|--|



| | | | | | |
|-----|---|--|-----|---|--|
| 26) | <p>043-01-0027</p>  | <p>SPRING INSULATOR PAD, LOWER Freightliner- 112080700/1120806000/ Freightliner - 1119583000/1119580000 #MFL4891</p> | 27) | <p>043-01-0028</p>  | <p>SHIFTER ISOLATOR BUSHING KIT Freightliner:FUL K-3399 ATRO MS99-63399 Fuller:K3399 VOLVO176640 International:FULK3399 MACK:3088-K3399 Peterbilt:FULK:3399 id:0.84",od:1 1/2",L:2.3" #M23311</p> |
|-----|---|--|-----|---|--|



| | | | | | |
|-----|--|---|-----|---|--|
| 28) | <p>043-01-0029</p>  | <p>SPRING PIN,5.750" B1244-46 Freightliner16-10510-000 #M4956</p> | 29) | <p>043-01-0030</p>  | <p>SPRING PIN, 5.968" B 1488-46 Freightliner 6803250074 #M5444</p> |
|-----|--|---|-----|---|--|







| | | | | | |
|-----|--|--|-----|--|---|
| 30) | <p>043-01-0031</p>  | <p>SPRING PIN, 6.375" B1245-46 Freightliner 16-10509-000 #M4958</p> | 31) | <p>043-01-0032</p>  | <p>SPRING PIN ,6.875" B 1445-46 Freightliner 16-13470-000 #M5284</p> |
| 32) | <p>043-01-0033</p>  | <p>SPRING PIN ,6-7/8" B1438-46 16-13079-000 #M5358</p> | 33) | <p>043-01-0034</p>  | <p>LEAF SPRING PIN, 6.906" B 1408-46 Freightliner 16-12373-000 Freightliner 16-13079-000 Freightliner 1613470000 Meritor R308796 #M5358/M5284</p> |
| 34) | <p>043-01-0035</p>  | <p>LEAF SPRING PIN, 7.375"(THREADED PIN) INTERNATIONAL - B1409-46 Freightliner 16-12302-000 Thread 1 1/4"-7" M4910</p> | 35) | <p>043-01-0036</p>  | <p>SPRING EYE BUSH Freightliner: 6803220150/ 1615951000/1617769000/ 6803220301 Hendrickson:37904 id:20,od:57,L1:100,L2:108mm id:3/4",od:2 1/4",L1:4",L2:4 1/4" #MR668</p> |







| | | | | | |
|-----|--|---|-----|--|---|
| 36) |  <p>043-01-0037</p> | <p>BI-METAL BUSH SPRING PIN Length 4" x OD 1.50" X ID 1.25 " FREIGHTLINER 1612399001 HENDRICKSON 30057007 MERITOR R3814221 ALSO USED FOR NAVISTAR, KENWORTH, PETERBILT id:1.25,od:1.50"L:4"</p> | 37) |  <p>043-01-0038</p> | <p>THREADED SPRING PIN BUSHING, L:4",Thread:1 1/4"-7 thread Freightliner 16-12301-000 Hendrickson 37599-003 MTB170 OD:1 1/2"</p> |
| 38) |  <p>043-01-0039</p> | <p>SHACKLE Freightliner16-11890-001 Freightliner 16-12302-000 Freighliner 16-12373-000 Freightliner 16-12470-000 Freightliner 16-12399-00 Freightliner A16-12301-0 Freightliner 16-11890-000 id:1.25",thk:1",W:2",L:7.8125", CTC:5.3125" #M1306/M5284/M5286/ M5358/MTB170/OGB-RNK</p> | 39) |  <p>043-01-0040</p> | <p>SHIM Single Slot Tandem Truck Shim, 1/32" Single Slot Tandem Truck Shim, 1/16" Single Slot Tandem Truck Shim, 1/8"</p> |
| 40) |  <p>043-01-0041</p> | <p>HEAVY DUTY TRUCK ALIGNEMENT SPACERS, 1/32" TORQUE ARM SHIMS,FREIGHTLINER 1/16" TORQUE ARM SHIMS,FREIGHTLINER 1/8"</p> | 41) |  <p>043-01-0042</p> | <p>RADIATOR MOUNT BUSHING Freightliner #05-16070-000 id:1 1/16",od:2 15/16",L 1 13/16" #M17335 Lower M17337 Upper M17341</p> |

| | | | | | |
|------------|--|---|------------|--|---|
| <p>42)</p> | <p>043-01-0043</p>  | <p>FRONT RADIATOR MOUNT Freightliner BCD 28721-1 Freightliner BCD 28847-1 #M203055 M203055</p> <p>ALUMINIUM BLOCK 05-19872-000 Thk:1 1/4", W:3 7/8", L:4", CTC:1 1/4", CTC2:1 7/8"</p> | <p>43)</p> | <p>043-01-0044</p>  | <p>EXHAUST GROMMET WWS LORCB2201-2 #M17383</p> |
| <p>44)</p> | <p>043-01-0045</p>  | <p>MOTOR MOUNT, UPPER (REAR) Freightliner BCD 27330 1 Freightliner BCD 27330 2 Freightliner BCD 288051 Freightliner BCD 267012 Freightliner BCD 26907-1</p> <p>W:3", L:9.875", CTC:8.3215", Bolt hole:0.5625 #M17395/M17397</p> | <p>45)</p> | <p>043-01-0046</p>  | <p>EXHAUST CLAMP 4"</p> |
| <p>46)</p> | <p>043-01-0047</p>  | <p>AIR COOLER HOSE (HUMP HOSE) 4"x5" AIR COOLER HOSE (HUMP HOSE) 4"x6.25" AIR COOLER HOSE (HUMP HOSE) 4"x7" AIR COOLER HOSE (HUMP HOSE) 4"x8" AIR COOLER HOSE (HUMP HOSE) 3.5"x6.25" AIR COOLER HOSE (HUMP HOSE) 3.5"x6.50"</p> | <p>47)</p> | <p>043-01-0048</p>  | <p>CLEVIS Freightliner A6809960540 MERITOR R801713 MERITOR R810019 MERITOR R1245P1030 MERITOR R1245T332 MERITOR R1245Z1066 1/2" Pin & 1/4" 5/8-18 # YK 5008</p> |

| | | | | | |
|-----|--|-------------------------|-----|--|-------------------------|
| 48) | 043-01-0049  | SHOCK ABSORBER 85000 | 49) | 043-01-0050  | SHOCK ABSORBER 85724 |
|-----|--|-------------------------|-----|--|-------------------------|

| | | | | | |
|-----|---|-------------------------|-----|---|-------------------------|
| 50) | 043-01-0051  | SHOCK ABSORBER 85918 | 51) | 043-01-0052  | SHOCK ABSORBER 85901 |
|-----|---|-------------------------|-----|---|-------------------------|

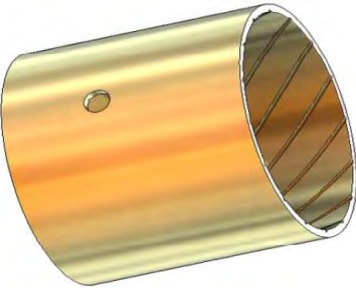





| | | | | | |
|----|--|--|----|--|--|
| 1) | <p>044-01-0001</p>  | <p>MACK UPPER TRUNION,UPPER 39QK433,39QK433A 25163274 M1134</p> | 2) | <p>044-01-0002</p>  | <p>MACK UPPER TRUNION,LOWER 39QK431 M1144</p> |
| 3) | <p>044-01-0003</p>  | <p>MACK TRUNION ASSY,3 1/2"X4" 39QK326/39QK27E/39QK27F M1119/M1116</p> | 4) | <p>044-01-0004</p>  | <p>MACK TRUNION ASSY 39QK396 M1206</p> |
| 5) | <p>044-01-0005</p>  | <p>MACK TRUNION ASSY,4"X4" 39QK325,39QK54 M1117</p> | 6) | <p>044-01-0006</p>  | <p>MACK TRUNION ASSY 39QK226C,39QK427B M1118</p> |

| | | | | | |
|-----|--|--|-----|---|--|
| 7) | <p>044-01-0007</p>  | <p>MACK TRUNION BUSH 10QK219P1 325-117 MSB506</p> | 8) | <p>044-01-0008</p>  | <p>MACK TRUNION BUSH 10QK371A MERITOR R302927 A988</p> |
| 9) | <p>044-01-0009</p>  | <p>MACK TRUNION BUSHING id:3 7/16",od:4 7/16",L:7 9/16" 10QK149/10QK147 MSB 506M</p> | 10) | <p>044-01-0010</p>  | <p>MACK TRUNION BUSHING 10QK219P2/10QK219P2 MSB684P3</p> |
| 11) | <p>044-01-0011</p>  | <p>MACK TRUNION BUSHING,BRONZE id:3.5",od"3.750",Ht:3.437" 10QK157/10QK255</p> <p>MACK TRUNION BUSHING,Bronze id:5",od"5 1/4" 80AX560 MX500</p> <p>MACK TRUNION BUSHING,Bronze id:4",od"4 1/4" 80AX560 MX500</p> | 12) | <p>044-01-0012</p>  | <p>MACK TRUNION BUSHING 10QK368A A988</p> |

| | | | | | |
|-----|--|--|-----|--|--|
| 13) | <p>044-01-0013</p>  | <p>MACK TRUNION MOUNT 8.5",2.5" Deep,6 Holes 97QL3101/25164367</p> | 14) | <p>044-01-0014</p>  | <p>MACK TRUNION CAP 97QL399P2/97QL399P2 id:5 3/4",od:7 3/4",depth:1 1/2",boltholes:5/16" on 7"BC M1158/MX306</p> |
| 15) | <p>044-01-0015</p>  | <p>MACK TRUNION CAP 97QL3001P2/97QL3001P3 id:5 3/4",od:7 3/4",depth:1 1/2",boltholes:5/16" on 7"BC MX406</p> | 16) | <p>044-01-0016</p>  | <p>MACK TRUNION SHAFT NUT 25QJ220BP2 Thikness : 1.185", Threads: 3-7/8"-12 MX404</p> |
| 17) | <p>044-01-0017</p>  | <p>MACK TRUNION SHAFT NUT 3 7/8"-8X6.09"X1.28"THK 25QJ220B MX504</p> | 18) | <p>044-01-0018</p>  | <p>MACK TRUNION ADJUSTING COLLAR NUT id: 3 5/16"-12,od:4",thk: 1" 25QJ223</p> |

| | | | | | |
|-----|--|---|-----|--|---|
| 19) | <p>044-01-0019</p>  | <p>MACK TRUNION LOCK RING 23QJ24A MX405</p> | 20) | <p>044-01-0020</p>  | <p>MACK TRUNION LOCK id:2 21/64",od: 4 7/8",thk 1/4" 23QJ112B</p> |
| 21) | <p>044-01-0021</p>  | <p>MACK BUMPER 12QK164A MACK FRONT SPRING BUMPER 12QK185</p> | 22) | <p>044-01-0022</p>  | <p>SPRING BUMPER MACK/VOLVO 12QK132/12QK185</p> |
| 23) | <p>044-01-0023</p>  | <p>MACK RADIATOR BUSHING 20QL259A</p> | 24) | <p>041-01-0024</p>  | <p>MACK RADIATOR BUSHING 20QL295M M62247</p> |







| | | | | | |
|-----|--|--|-----|--|--|
| 25) | <p>044-01-0025</p>  | <p>MACK INSULATOR RADIATOR 20QL302P2 25155783</p> | 26) | <p>044-01-0026</p>  | <p>MACK RADIATOR MOUNT 20QL231P11</p> |
| 27) | <p>044-01-0027</p>  | <p>MACK, CAB INSULATOR 20QL250 id:3 7/16",od:4 11/16",L:5 9/16"</p> <p>MACK INSULATOR ENGINE 20QL231P10</p> | 28) | <p>044-01-0028</p>  | <p>MACK SPACER, CAB MOUNT 20QL1168D</p> |
| 29) | <p>040-01-0029</p>  | <p>TORQUE ROD BUSH od: 2 1/16",L:6 5/8",CTC:4 3/8",Bolt Hole:5/8" 47691-000L Suitable to Freightliner A16-119448 Hendrickson 47691 International:ZJF47691L TRB6185</p> | 30) | <p>040-01-0030</p>  | <p>TORQUE ROD BUSH DAYTON 321-519 MACK SS-R0035P240 Volvo:20486749/20448089 #TRB 6199</p> |







| | | | | | |
|-----|--|---|-----|--|---|
| 31) | <p>040-01-0031</p>  | <p>MACK INSULATOR 20QL118A</p> <p>MACK MINSULATOR 20QL1171</p> | 32) | <p>040-01-0032</p>  | <p>MACK HOOD MOUNT 20QL2101 M62101</p> |
| 33) | <p>040-01-0033</p>  | <p>MACK FRONT ENGINE MOUNT 20QL312M2 ID:1 1/6",OD1: 1 3/8",OD2:2 5/8"</p> | 34) | <p>040-01-0034</p>  | <p>HOOD BUMPER 20QP1175 Meritor, R307477 M1</p> |
| 35) | <p>044-01-0035</p>  | <p>MACK ENGINE INSULATOR 20QL252P3</p> | 36) | <p>044-01-0036</p>  | <p>MACK UPPER INSULATOR 10QK32BP1 ABP5 Load Pad Upper Height: 3 3/4" Width: 5 3/8" Length: 6 7/8" Pin OD: 1 1/2" Meritor R303679,</p> |





| | | | | | |
|-----|--|--|-----|--|--|
| 37) | <p>044-01-0037</p>  | <p>MACK INSULATOR id:0.875",od1:2.25",od2:3.5"L:3" 20QL258/20QL2110 M5 d280</p> | 38) | <p>040-01-0038</p>  | <p>MOTOR MOUNT MACK 20QL37P4/20001554 PETERBILT 518263/CB2203-0 ASSEMBLED Ht:2.430" M17843</p> |
| 39) | <p>044-01-0039</p>  | <p>MACK SPRING INSULATOR 10QK332A</p> | 40) | <p>044-01-0040</p>  | <p>INSULATOR PAD, LOWER 10QK36B Volvo 21036254 ABP2</p> |
| 41) | <p>044-01-0041</p>  | <p>MACK ENGINE MOUNT,UPPER 10QK343P7, 10QK365, 10QK365A, 10QK367, R302917, CS71638B VOLVO 25121508</p> | 42) | <p>044-01-0042</p>  | <p>MACK INSULATOR PAD,UPPER Thk:3",W:6",L:41/2",Dowell:1 3/4" 10QK33A 325-109 ABP3</p> |



| | | | | |
|-----|--|--|---|---|
| 43) | <p>044-01-0043</p>  | <p>MACK INSULATOR PAD LOWER od:1 1/4",L:5 11/16",CTC:4 7/32" 10QK372 ABP6</p> | <p>44)</p> <p>044-01-0044</p>  | <p>MACK INSULATOR PAD 10QK48 MERITOR R303919 ABP9P/ABP9</p> |
| 45) | <p>044-01-0045</p>  | <p>MACK SHOCK BUSHING L:1",id:1 1/16",Od1:1 7/8",Od2:1 1/2" 14QK136 KENWORTH 73D2002 PETERBILT 02-00377 MH1432</p> | <p>46)</p> <p>044-01-0046</p>  | <p>MACK TRANS MOUNT 20QL324M id:7/8",od1:3 3/4",od2:2"</p> |
| 47) | <p>044-01-0047</p>  | <p>MACK INSULATOR AIR DUCT 20QL29304</p> | <p>48)</p> <p>044-01-0048</p>  | <p>MACK INSULATOR SPACER 4.75",H 1 7/16" 13QK246</p> |

| | | | | | |
|-----|--|---|-----|--|---|
| 49) | <p>044-01-0049</p>  | <p>MACK INSULATOR BOX 52QK418AP4/52QK418BP4 M1070</p> | 50) | <p>044-01-0050</p>  | <p>LOWER THERMOSTAT HOSE 561.62745</p> |
| 51) | <p>044-01-0051</p>  | <p>UNIVERSAL HOOD LATCH,5" INTERNATIONAL 491668C92 FLH4664 MACK 3QM214</p> | 52) | <p>044-01-0052</p>  | <p>MACK LATCH KIT,BATTERY BOX 370SB26 Contains Latch 25162163, 3QM213, HLK2181 HLK2181K</p> |
| 53) | <p>044-01-0053</p>  | <p>MACK U BOLT TOPLATE 8QK335P2 L1"7.500",L2:9 1/4"</p> | 54) | <p>040-01-0054</p>  | <p>MACK U BOLT TOPLATE 8QK335P1 L1"6.500",L2:8.25",W:4"</p> |



| | | | | | |
|-----|--|---|-----|--|---|
| 55) | <p>044-01-0055</p>  | <p>MACK SPRING BUSHING B:4"/C:4 1/4",D:1" Mack 10QK260 Hendrickson 37795 RB-187 MR 620</p> | 56) | <p>044-01-0056</p>  | <p>MACK LEAF SPRING BUSHING CTC:4.375",od:2",Bolt hole:0.625" id:3.4375",od:4.4375"L:8.375" 10QK130P1 MERITOR R302924A/R307741 MSB506L</p> |
| 57) | <p>044-01-0057</p>  | <p>MACK SPRING EYE BUSH 10QK146B/10QK146 HENDRICKSON 37880 id:1/4",od: 2 1/2" ,L:4" MR192</p> | 58) | <p>044-01-0058</p>  | <p>MACK FRONT INSULATOR id:4 7/16",od:5 13/16" M3</p> |
| 59) | <p>044-01-0059</p>  | <p>MACK INSULATOR (SET OF 2) 12QL281 20QL1166 EM 46500 od:5.8125",thk:0.625",W1:15/16",W2:1.25" ,H:2.875"</p> | 60) | <p>044-01-0060</p>  | <p>MACK INSULATOR (SET OF 2) 20QL2101 ID:4 7/16",OD:5 13/16"</p> |

| | | | | | |
|-----|--|--|-----|--|--|
| 61) | <p>044-01-0061</p>  | <p>MACK,SHACLE PLATE,2" L:6 5/16",CTC:4",Hole dia:1 1/16" 22QK39301 M876</p> | 62) | <p>044-01-0062</p>  | <p>MACK U BOLT TOPLATE,5" 8QK232A L1"7.500",L2:9 1/4" M935</p> |
| 63) | <p>044-01-0063</p>  | <p>MACK THRUST WASHER,BRONZE id:3 1/2",od:5 5/16",thk:1/4" 43Q116</p> | 64) | <p>044-01-0064</p>  | <p>MACK THRUST WASHER,BRONZE 43QK115 25158710 MX402 id:4 1/32",od:6 3/16",thk:1/4"</p> |
| 65) | <p>044-01-0065</p>  | <p>MACK THRUST WASHER,BRONZE 43QK234 MX502 id:5 1/64",od:6 11/16",thk:1/4"</p> | 66) | <p>044-01-0066</p>  | <p>MACK THRUST WASHER,STEEL 43QK118 MX403 id:4 1/32",od:6 1/4",thk:5/16"</p> |

| | | | | | |
|-----|---|--|-----|--|--|
| 67) | <p>044-01-0067</p>  | <p>MACK THRUST WASHER,STEEL id:3 1/2",od:5 3/8",thk:3/8" 43QK117</p> | 68) | <p>044-01-0068</p>  | <p>MACK U BOLT WASHER id:15/16",od:1 3/4",thk:1/8" 37AX1310</p> |
| 69) | <p>044-01-0069</p>  | <p>MACK OUTER SPACER id:3 1/2",od:4 1/8",W:1 3/4" 44RU221P2 MMW10</p> | 70) | | |
| 71) | <p>044-01-0070</p>  | <p>INSULATOR BOLT, 7/8"-14TPI,L:5 " 1AX425 INSULATOR BOLT, 7/8"-14TPI,L:5 1/4" 1AX475 INSULATOR BOLT, 7/8"-14TPI,L:6" 1AX427 , 3AX987 INSULATOR BOLT, 7/8"-14TPI,L:6 1/2" 3AX1344 INSULATOR BOLT, 7/8"-9TPI,L:6" 6AX1160</p> | 72) | <p>044-01-0071</p>  | <p>INSULATOR BOLT, 7/8"-14TPI,L:7" 3AX1682 INSULATOR BOLT , 7/8"-14TPI,L:7 1/2" 3AX1050 INSULATOR BOLT, 7/8"-14TPI,L:8" 3AX1348 INSULATOR BOLT, 7/8"-14TPI,L:8 1/2" 3AX1343 INSULATOR BOLT, 7/8"-9TPI,L:4 1/2" 4AX320,6AX837</p> |



| | | | | | |
|----|--|--|----|--|--|
| 1) | <p>047-01-0001</p>  | <p>COOLANT HOSE CATERPILLAR # 247-0266</p> | 2) | <p>047-01-0002</p>  | <p>COOLANT HOSE CATERPILLAR # 247-0056</p> |
| 3) | <p>047-01-0003</p>  | <p>COOLANT HOSE CATERPILLAR # 247-0055</p> | 4) | | |

| | | | | | |
|----|--|--|----|--|--|
| 1) | <p>048-01-0001</p>  | <p>LEAF SPRING PIN ,(THREADED PIN) B1221-55 Thread 1-3/8"x6" International:555175C2/ 688953R1 #M4910</p> | 2) | | |
|----|--|--|----|--|--|

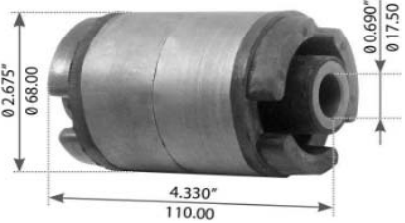
| | | | | | |
|----|--|---|----|--|---|
| 1) | <p>016-01-0001</p>  | <p>CAB SUSPENSION SPRING 23214277</p> | 2) | <p>016-01-0002</p>  | <p>ENGINE MOUNT L:250mm,Bore:14.5mm, W:211mm,ht:105mm Thrd:M20X2.5mm VOLVO : 20499469/20723224 21228153</p> |
|----|--|---|----|--|---|

| | | | | | |
|----|--|--|----|--|--|
| 3) | <p>016-01-0003</p>  | <p>CAB MOUNT BUSH id:0.690",L:4.330",W:2.675" Volvo:M206054 Volvo:8074666/S21745 #TF 10162</p> | 4) | | |
|----|--|--|----|--|--|

| | | | | | |
|----|--|---|----|--|--|
| 1) | <p>049-01-0001</p>  | <p>RUBBER SPRING D:9 1/2",L:8" Newstar:S-19168 #MLC11</p> | 2) | | |
|----|--|---|----|--|--|

| | | | |
|----|---|---|---|
| 1) | <p>050-01-0001</p>  | <p>CENTER BEARING SPICER No.5003325 Bearing id:2.362" Dimension C/L to Mounting:3.33</p> <p>Bracket Width:2.917mm Carrier Bearing type:25 Meritor:CB210661-1XSA SP5003323</p> | 2) |
| 3) | <p>037-01-0059</p>  | <p>BRAKE REPAIR KIT Meritor 4515QHDK #100.4515.22 DAYTON/BATCO 05108800</p> | <p>4)</p> <p>050-01-0002</p>  <p>CLEVIS Pin 5/8", thrd:5/8"-18 thrds MERITOR 1245-D-186 # YK 5813</p> |



| SR NO. | TRUSTTEC NO. | PART NO. | QTY | DESCRIPTION | SIZE |
|--------|--------------------|---------------------------|-----|-------------------|-----------------------------|
| | 037-01-0057 | 8000MBHD K1007 | | Brake Shoe Kit | 420 or 380mm Ø drum, Qshoes |
| 1 | 037-01-0065 | 1259-N-274 | 2 | Anchor Pin | |
| 2 | 037-01-0066 | 2258-W-803 | 1 | Return Spring | |
| 3 | 037-01-0067 | 2258-Q-615 | 2 | Return Spring | |
| 4 | 037-01-0068 | 2297-T-7222 | 2 | Brake Shoe Roller | |
| 5 | 037-01-0069 | 1218-G-85 | 2 | Return Spring Pin | |
| 6 | 037-01-0070 | 3105-B-210 | 2 | Roller Retainer | |

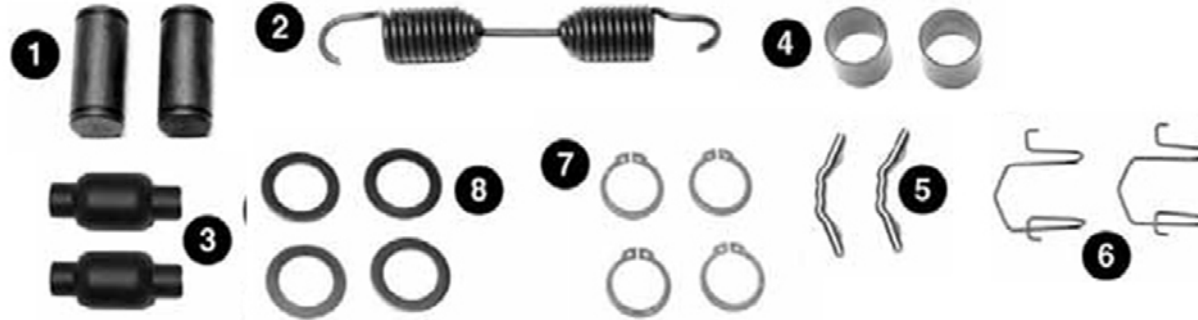

| SR NO. | TRUSTTEC NO. | PART NO. | QTY | DESCRIPTION | SIZE |
|--------|--------------------|------------------|-----|--------------------|-----------------------------|
| | 037-01-0058 | R509001 | | Brake Shoe Kit | 420 & 380mm Ø drum, P shoes |
| 1 | 037-01-0071 | 1259-M-1131 | 2 | Anchor Pin | |
| 2 | 037-01-0072 | 2258-Z-416 | 1 | Return Spring | |
| 3 | 037-01-0068 | 2297-T-7222 | 2 | Brake Shoe Roller | |
| 4 | 037-01-0073 | R547008 | 2 | Anchor Pin Bushing | |
| 5 | 037-01-0069 | 1218-G-85 | 2 | Return Spring Pin | |
| 6 | 037-01-0074 | 1718-Y-103 | 2 | Roller Retain er | |
| 7 | 037-01-0075 | 1229-D-2942 | 4 | Snap Ring | |
| 8 | 037-01-0076 | 1229-B-1848 | 4 | Washer | |
| | | | | | |
| | | | | | |
| | | | | | |
| | | | | | |



| SR NO. | TRUSTTEC NO. | PART NO. | QTY | DESCRIPTION | SIZE |
|--------|--------------------|----------------|-----|-------------------------------|---------------------------|
| | 037-01-0060 | AXL-126 | | SERIES III SHORT KIT | 420 & 350mmØ drum Q Shoes |
| 1 | 037-01-0077 | 21006610 | 2 | Camshaft roller | |
| 2 | 037-01-0078 | 21016666A | 2 | Anchor pin bush (indented) | |
| 3 | 037-01-0079 | 21224831 | 2 | Roller retainer clip | |
| 4 | 037-01-0080 | 21205193G | 2 | Anchor pin (grooved) | |
| 5 | 037-01-0081 | 21205194 | 2 | Retainer spring | |
| 6 | 037-01-0082 | 21220668 | 4 | 'O' ring (high temperature) | |
| 7 | 037-01-0088 | 21214204 | 1 | Grease sachet | |
| 8 | 037-01-0089 | 21220171 | 2 | Roll pin | 12.7mm x 63.0mm |
| 9 | 037-01-0090 | 21221224 | 1 | Brake return spring (350/420) | |
| | | | | | |
| | | | | | |
| | | | | | |



| SR NO. | TRUSTTEC NO. | PART NO. | QTY | DESCRIPTION | SIZE |
|--------|--------------------|----------------|-----|-----------------------------------|-------------------------|
| | 037-01-0062 | AXL-LM4 | | BRAKE ANCHOR PIN & CAM ROLLER KIT | 420 mm Ø drum , Q shoes |
| 1 | 037-01-0091 | 15226632 | | Anchor pin & bush assembly | |
| 2 | 037-01-0092 | 15226262 | | Cam roller assembly | |
| 3 | 037-01-0090 | 21221224 | | Brake return spring | |
| 4 | 037-01-0081 | 21205194 | | RetainingRetaining | |
| 5 | 037-01-0093 | 99226786 | | springspring | |
| | | | | Sachet high | |









| SR NO. | TRUSTTEC NO. | PART NO. | QTY | DESCRIPTION | SIZE |
|----------|--------------------|-------------|-----|--------------------|------|
| | 037-01-0064 | 8080 | | MINOR KIT | |
| 1 | 037-01-0067 | 2258-Q-615 | 2 | Retainer Spring | |
| 2 | 037-01-0094 | 2258-Y-1273 | 1 | Return Spring | |
| 3 | 037-01-0065 | 1259-N-274 | 2 | Anchor Pin | |
| 4 | 037-01-0095 | 1225-B-496 | 2 | Anchor Pin Bushing | |
| | | | | | |
| | | | | | |
| | | | | | |
| | | | | | |
| | | | | | |
| | | | | | |
| | | | | | |
| | | | | | |













| SR NO. | TRUSTTEC NO. | PART NO. | QTY | DESCRIPTION | |
|--------|--------------------|---------------|-----|---------------------------------|---|
| | 037-01-0059 | 8000HD | | BRAKE SHOE, HARDWARE KIT | |
| 1 | 037-01-0065 | 1259-N-274 | | Anchor Pin | Hendrickson: S21183/S23752 Meritor: 8000HD/KIT8000BK/KIT8000 BULK Consists of: Shoe Return Spring: Hendrickson B23439,Meritor:R567010/Spring Clip:Fruehauf 583015, Volvo 870985,Meritor 1218-G-85 Hendrickson:S21183/S23752 Meritor:8000HD/KIT8000BK/KIT8000BULK Consists of:Shoe Return Spring:Hendrickson B23439,Meritor:R567010/Spring Clip:Fruehauf 583015,Volvo 870985,Meritor 1218-G-85, Spring:5 1/2" inside hooks,3/4" od,m-1423,Bushing:Meritor R547008,Anchor Pin:Hendrickson A20689, Meritor 1259-E-291,Roller Retainer:M1433,Brake Shoe Roller:E2177 |
| 2 | 037-01-0068 | 2297-T-7222 | | Brake Shoe Roller | |
| 3 | 037-01-0095 | 1225-B-496 | | Anchor Pin Bushing | |
| 4 | 037-01-0069 | 1218-G-85 | | Return Spring Pin | |
| 5 | 037-01-0070 | 3105-B-210 | | Roller Retainer | |
| 6 | 037-01-0066 | 2258-W-803 | | Return Spring | |
| 7 | 037-01-0067 | 2258-Q-615 | | Retainer Spring | |
| | | | | | |
| | | | | | |
| | | | | | |
| | | | | | |
| | | | | | |
| | | | | | |
| | | | | | |
| | | | | | |
| | | | | | |
| | | | | | |
| | | | | | |



| SR NO. | TRUSTTEC NO. | PART NO. | QTY | DESCRIPTION | |
|--------|--------------------|-------------|-----|---------------------------------|--|
| | 037-01-0063 | 8081 | | BRAKE SHOE, HARDWARE KIT | Meritor:508053 |
| 1 | 037-01-0094 | 2258-Y-1273 | | Return Spring | Consists of:Roller E2177,Brake Shoe Spring Meritor 2258-Y-1273,Bushing:Meritor R547008,Brake Shoe Spring:Hendrickson B-20693,Fruehauf ACF-3079-001,Meritor 2258-Q-615,Anchor Pin:Hendrickson A-20689,Meritor 1259-E-291,Brake Shoe Spring Pin: Fruehauf 583015,Volvo 870985,Meritor 1218-G-85,Roller Retainer Fruehauf 330734,Mack 341SM18,Volvo 827703,Hendrickson A-27210,Meritor 1718-Y-103 |
| 2 | 037-01-0067 | 2258-Q-615 | | Retainer Spring | |
| 3 | 037-01-0065 | 1259-N-274 | | Anchor Pin | |
| 4 | 037-01-0095 | 1225-B-496 | | Anchor Pin Bushing | |
| 5 | 037-01-0068 | 2297-T-7222 | | Brake Shoe Roller | |
| 6 | 037-01-0070 | 3105-B-210 | | Roller Retainer | |
| 7 | 037-01-0069 | 1218-G-85 | | Return Spring Pin | |
| | | | | | |
| | | | | | |
| | | | | | |
| | | | | | |

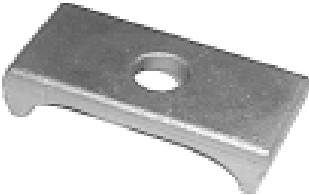

| | | | | | |
|----|--|---|----|--|---|
| 1) | <p>042-01-0001</p>  | <p>FRONT HANGER, UNDER MOUNT F Series Suspensions FRUEHAUF - UCF002467 001 E2826 M6120</p> | 2) | <p>042-01-0002</p>  | <p>FRONT HANGER, UNDER MOUNT Wide Base, F Series Suspensions FRUEHAUF - UCF001466 001 E2822 MERTOR - R302822 M6112</p> |
| 3) | <p>042-01-0003</p>  | <p>EQUALIZER HANGER, UNDER MOUNT F Series Suspensions FRUEHAUF - UXA000034-900/ UXA0034-000 E2827 MERITOR - R302827 M6122</p> | 4) | <p>042-01-0004</p>  | <p>EQUALIZER HANGER, UNDER MOUNT Wide Base, F Series Suspensions FRUEHAUF - UCE007746 001 E2823 MERITOR - R302823 M6114</p> |
| 5) | <p>042-01-0005</p>  | <p>DUCTILE CAST EQUALIZER F Series Suspensions FRUEHAUF - UCF006963 001 UCF0066963-001 MERITOR - R308931 EQ023 E8931</p> | 6) | <p>042-01-0006</p>  | <p>CAST EQUALIZER Series Suspensions FRUEHAUF - UXA000017 UXA000017T MERITOR - R302830 EQ015 E2830</p> |

| | | | | | |
|-----|--|--|-----|--|---|
| 7) | <p>042-01-0007</p>  | <p>REAR HANGER, UNDER MOUNT F Series Suspensions FRUEHAUF - UCF002470 001 UCF002470001 UCF2470-1 MERITOR - R302828 M6124 E2828</p> | 8) | <p>042-01-0008</p>  | <p>REAR HANGER, UNDER MOUNT Wide Base, F Series Suspensions FRUEHAUF - UCF00585800 UCF-5858-001 U-CF5858-1 MERITOR - R302824 E-2824</p> |
| 9) | <p>042-01-0009</p>  | <p>EQUALIZER, W/BUSHING NF-2 Series Suspension FRUEHAUF - UCF008317001 UCF6697001/UCF8317002/02 UCF0083170 MERITOR - R309366 E9366 EQ039</p> | 10) | <p>042-01-0010</p>  | <p>EQUALIZER BOLT KIT NF-2 Series Suspension FRUEHAUF - UCF006703901 U-CF6703-901</p> |
| 11) | <p>042-01-0010</p>  | <p>RIGID TORQUE ARM F Series Suspensions FRUEHAUF - UXA000026-001 15 7/16" C/C Length MERITOR -R302514 E2514 TR021</p> | 12) | <p>042-01-0011</p>  | <p>ADJUSTABLE RADIUS ROD F Series Suspensions FRUEHAUF - U-CF2640-1 - 15 7/16" FRUEHAUF - U-CF2640-4 - 12 3/8" E2515 TR006</p> |

| | | | | | |
|-----|--|---|-----|--|---|
| 13) | <p>042-01-0012</p>  | <p>SPRING SPACER F Series Suspensions FRUEHAUF - UXA000048/UXA0048 1 1/2" High, 3" Wide, 6 1/2" Long E2838 MERITOR -R302838 M8144</p> | 14) | <p>042-01-0013</p>  | <p>AXLE BRACKET, For 5" Rd AXLE F2 Series Suspensions FRUEHAUF - UXA00028</p> |
| 15) | <p>042-01-0014</p>  | <p>AXLE BRACKET, For 5" Sq. AXLE F Series Suspensions FRUEHAUF - AXA000495-001 E2836 MERITOR -R302836</p> | 16) | <p>042-01-0015</p>  | <p>SPRING SEAT F Series Suspensions FRUEHAUF - AXA000512-001 E2837 MERITOR -R302837 M8124</p> |
| 17) | <p>042-01-0016</p>  | <p>5" Rd AXLE SEAT for F2 SUSPENSION FRUEHAUF - ACF008391-001 UXA000047001 M8139</p> | | | |

RADIUS ROD BUSHING KIT









| | TRUSTTEC NO. | PART NO. | | APPLICATIONS / INTERCHANGE INFORMATION |
|----|--------------|--|----|---|
| | 042-01-0017 | FRUEHAUF - U-XA0011-900 100113 E1023 MERITOR -R301023 TRK6300 | | |
| 1) | 042-01-0018 | BOLT FRUEHAUF - U-XA0016 / UJA-0034-001 MERITOR -R301018 E1018 / TRS0339 L:7.125, Thread L:1.500", Thread : 1.0"-14, Dia : 1.25" | 2) | 042-01-0019  WASHER FRUEHAUF - U-XA0356-001 UJA-0035-001 E1074 64x32x3mm |
| 3) | 042-01-0020 | BUSHING FRUEHAUF - UXA-000011/ UXA-0011-000/586121 /UJA-0033-001S Meritor:R30927 Hutch:7620-00 TRB 6300, E927 31.8x55.6x60mm | 4) | 042-01-0021  WASHER FRUEHAUF - U-XA0002 UJA-0097-001 E2833 64x26x6mm |
| 5) | 042-01-0022 | NUT FRUEHAUF - FSP 6-2-9 / EPS-0602-002 / E1828 M24x3P THREAD 21206001 NLN113 | 6) | |







EQUALIZER BUSHING KIT







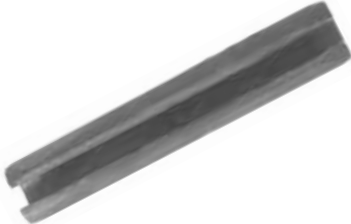







| | TRUSTTEC NO. | PART NO. | | APPLICATIONS / INTERCHANGE INFORMATION |
|----|-----------------|--|----|--|
| | 042-01-0023 | FRUEHAUF - U-XA0004-900 10014 NL3001 / E1024 MERITOR -R301034 TRK5384 | | |
| 1) | 042-01-0024 | BOLT FRUEHAUF - UXA-000015-001 UXA-00004-001 / UJA-0324-001 E1019 MERITOR -R301019 TRS4309 | 2) | 042-01-0025 WASHER FRUEHAUF - UXA000003/UXA0003 UJA-0097-002 E1021 MERITOR -R301021 WA03 |
| 3) | 042-01-0026 | BUSHING FRUEHAUF - UXA00004/ UXA-0004 UJA-0030-001 MERITOR -R301020 TRB5384 / E-1020 d:51, D:88, H:112 | 4) | 042-01-0027 WASHER FRUEHAUF - UXA-000356-002 / UJA-0032-001 E2832 / E5137 MERITOR -R627031 114.1082 |
| 5) | 042-01-0028 | NUT FRUEHAUF - FSP-006-02-PK9 / PK9EPS-0602-002 E1828 / MERITOR -R30937 1"-14 Thread, 1-7/16" Hex, 7/8" Height | 6) | |





| | | | | | |
|------------|--|---|------------|--|---|
| <p>18)</p> | <p>042-01-0029</p>  | <p>SPRING SADDLE FRUEHAUF - UCE008801001 UCD007601-007 UCE-008801-00 U-CE8801-1 E2840 MERITOR -R302840 M470</p> | <p>19)</p> | <p>042-01-0030</p>  | <p>SPRING SADDLE FRUEHAUF - UCC005998001 U-CC5998-1 E2839 MERITOR -R302839 M471</p> |
| <p>20)</p> | <p>042-01-0031</p>  | <p>SLIDER LOCK PIN KIT Slider Pin Assembly FFRUEHAUF - CF006457-901 586191-900</p> | <p>21)</p> | <p>042-01-0032</p>  | <p>ADJ. TORQUE ARM UJA0024002 L:390</p> |
| <p>22)</p> | <p>042-01-0033</p>  | <p>ADJ. TORQUE ARM 85607 L:450</p> | <p>23)</p> | <p>042-01-0034</p>  | <p>ADJ. TORQUE ARM UJA0024003 L:570</p> |

| | | | | | |
|-----|--|--|-----|--|---|
| 24) | <p>042-01-0035</p>  | <p>RUBBER BUSHING FOR SPRING M001502 ø30xø68x104</p> | 25) | <p>42-01-0035</p>  | <p>BOLT, SPRING UJA-0324-001 272,5/M24x1,5</p> |
| 26) | <p>042-01-0036</p>  | <p>BOLT, SPRING UJA-0034-001 154/M24x1,5</p> | 27) | <p>042-01-0037</p>  | <p>REP. KIT SPRING BOLT ASSY. M008949 M30x3.5/210</p> |
| 28) | <p>042-01-0038</p>  | <p>BRAKE SHOE PIN AJA-0507-001 ø31.7x62.5</p> | 29) | <p>042-01-0039</p>  | <p>BRAKE SHOE PIN M-002866 ø31.7x70</p> |







| | | | | | |
|-----|--|--|-----|--|---|
| 30) | <p>042-01-0040</p>  | <p>BRAKE SHOE BUSHING AJA-0558-001 ø32xø35x37</p> | 31) | <p>042-01-0041</p>  | <p>BRAKE SHOE BUSHING ARJA0199-702S ø41,2xø50,9/ø54x51</p> |
| 32) | <p>042-01-0042</p>  | <p>LOCK PLATE, BRAKE SHOE M002693 21023758 ø19,5x37x55</p> | 33) | <p>037-01-0079</p>  | <p>LOCK PLATE, BRAKE SHOE AJA-0506-001 M002963 6504774T 21224831 21023758 id:19.5mm, int.width:33.5, H:29, W:40, L:55</p> |
| 34) | <p>042-01-0044</p>  | <p>LOCK PIN ø8.75x45x1.50</p> | 35) | <p>042-01-0045</p>  | <p>BRAKE SHOE SPRING AJB-0119-001 M002874 ø32x204</p> |

| | | | | | |
|-----|--|--|-----|--|--|
| 36) | <p>042-01-0046</p>  | <p>BRAKE SHOE SPRING AJA-0487-001 ø28x176</p> | 37) | <p>042-01-0047</p>  | <p>SPRING 170 x 28 x 3.75 mm, Active coils 22x</p> |
| 38) | <p>042-01-0048</p>  | <p>SPRING 165 x 25.4 x 3.75 mm, Active coils 22x</p> | 39) | <p>042-01-0049</p>  | <p>SPRING 43 x 11 x 1.25 mm, Active coils 9x</p> |
| 40) | <p>042-01-0050</p>  | <p>SPRING AJB0119001 CF102573 200 x 30 x 5 mm, Active coils 26</p> | 41) | <p>042-01-0051</p>  | <p>SPRING 160 x 25 x 3 mm, Active coils 39</p> |

| | | | | | |
|-----|--|---|-----|--|---|
| 42) | <p>042-01-0052</p>  | <p>SPRING PIN, BRAKE SHOE M003001 ø6x15</p> | 43) | <p>042-01-0053</p>  | <p>REP. KIT FOR BRAKE SHOE ARJA- 0199-703 ø31.7</p> |
| 44) | <p>042-01-0054</p>  | <p>REP. KIT FOR BRAKE SHOE ø31.7</p> | 45) | <p>042-01-0055</p>  | <p>REP. KIT FOR BRAKE SHOE ø31.7</p> |
| 46) | <p>042-01-0056</p>  | <p>REP. KIT FOR BRAKE SHOE ø31.7</p> | 47) | <p>042-01-0057</p>  | <p>REP. KIT FOR BRAKE SHOE ø31.7</p> |





| | | | | | |
|-----|--|--|-----|--|--|
| 48) | <p>042-01-0058</p>  | <p>REP. KIT FOR BRAKE SHOE M009279 ø31.7</p> | 49) | <p>042-01-0059</p>  | <p>REP. KIT FOR BEARING CR-26722-01 ø31x54/60x89</p> |
| 50) | <p>042-01-0060</p>  | <p>RETAINER, CAMSHAFT BUSH 1350200201 5049133 ø70x13</p> | 51) | <p>042-01-0061</p>  | <p>RETAINER, CAMSHAFT BUSH M003060 ø70x13</p> |
| 52) | <p>042-01-0062</p>  | <p>RETAINER, CAMSHAFT BUSH AJB-0001-001 AJB-0002-001 ø10.5/69.5xø64x20</p> | 53) | <p>042-01-0063</p>  | <p>CAMSHAFT BUSHING AEJA-0441-001 ø41xø51x22</p> |

| | | | | | |
|-----|--|---|-----|--|---|
| 54) | <p>042-01-0064</p>  | <p>CAMSHAFT BUSHING AEJA-0441-002A ø41xø51x22</p> | 55) | <p>042-01-0065</p>  | <p>SPHERICAL BEARING CF-1001312 ø38xø70x63</p> |
| 56) | <p>042-01-0066</p>  | <p>SPHERICAL BEARING AEJA-0442-001 ø40xø64x38</p> | 57) | <p>042-01-0067</p>  | <p>BRAKE CAMSHAFT BUSHING AJA-0753-001 ø41.5xø51x23</p> |
| 58) | <p>042-01-0068</p>  | <p>BRAKE CAMSHAFT BUSHING AJA-0753-002 ø41xø50.7x19</p> | 59) | <p>042-01-0069</p>  | <p>REP. KIT FOR CAMSHAFT M010676 ø38x509</p> |

| | | | | | |
|-----|--|---|-----|--|---|
| 60) | <p>042-01-0070</p>  | <p>REP. KIT FOR CAMSHAFT M050147 ø38x456</p> | 61) | <p>042-01-0071</p>  | <p>REP. KIT FOR CAMSHAFT, DOUBLE AEJB-0003-001 ø40xø64x38</p> |
| 62) | <p>042-01-0072</p>  | <p>REP. KIT FOR CAMSHAFT, SINGLE AEJB-0003-002 ø40xø64x38</p> | 63) | <p>042-01-0073</p>  | <p>REP. KIT FOR CAMSHAFT CF-100149 ø38xø70x63</p> |
| 64) | <p>042-01-0074</p>  | <p>REP. KIT FOR CAMSHAFT, DOUBLE ø40xø64x38</p> | 65) | <p>042-01-0075</p>  | <p>REP. KIT FOR CAMSHAFT AEJA-0442-001S ø40xø64x38</p> |

| | | | | | |
|-----|--|--|-----|--|--|
| 66) | <p>042-01-0076</p>  | <p>REP. KIT FOR CAMSHAFT ARJA-0199-702 ø40xø64x38</p> | 67) | <p>042-01-0077</p>  | <p>CAM ROLLER AJA-0504-002 ø19/ø25x57</p> |
| 68) | <p>042-01-0078</p>  | <p>CAM ROLLER AJA-0504-001 M-002971 ø19xø31.7x55.5</p> | 69) | <p>042-01-0079</p>  | <p>DUST COVER AJA-0483-001 AJA-0483-002 ø197xø463x72</p> |
| 70) | <p>042-01-0080</p>  | <p>DUST COVER ARJB-0006-701 ø178xø460x38</p> | 71) | <p>042-01-0081</p>  | <p>DUST COVER AJB-0006-001 AJB-0006-002 ø178xø460x38</p> |

| | | | | | |
|-----|---|---|-----|--|---|
| 72) | <p>042-01-0082</p>  | <p>DUST COVER SET OF 2, 9 & 10 TONS AXLE 449592 M009260 475 x 70 x 1 mm</p> | 73) | <p>042-01-0083</p>  | <p>DUST COVER SET OF 2, 12 TONS AXLE M010544 475 x 70 x 1 mm</p> |
| 74) | <p>042-01-0084</p>  | <p>HUB CAP AJA-0577-001 ø158 W8G/167</p> | 75) | <p>042-01-0085</p>  | <p>HUB CAP, ALUMINUM AJA-0492-001S ø158 W8G/73.5</p> |
| 76) | <p>042-001-0086</p>  | <p>HUB CAP, PLASTIC AJA-0492-001 ø158 W8G/76.5</p> | 77) | <p>042-01-0087</p>  | <p>PLUG, HUB CAP CF100140 AJA0733001 21202627 id:33, od:41, L:17 M10617</p> |

| | | | | | |
|-----|--|---|-----|--|--|
| 78) | <p>042-01-0088</p>  | <p>O RING, HUB CAP CF100136 Id:139.3 mm, Thk: 5.70 mm</p> | 79) | <p>042-01-0089</p>  | <p>SHAFT SEAL FOR AXLE M008892 153x108x30mm</p> |
| 80) | <p>042-01-0090</p>  | <p>OIL SEAL, HUB AJA0564001 153x107x31mm</p> | 81) | <p>042-01-0091</p>  | <p>OIL SEAL, HUB AJA0564003 448055 153x108x29 mm</p> |
| 82) | <p>042-01-0092</p>  | <p>SEAL HUB 10336 107.5x154x17.5mm</p> | 83) | <p>042-01-0093</p>  | <p>OIL SEAL ABS IMPULSE WHEEL M010498 108x152.6/185x19mm</p> |

| | | | | | |
|-----|--|---|-----|--|--|
| 84) | <p>042-01-0094</p>  | <p>SEAL RING, WHEEL HUB M003125 ø108xø152,6/ø185x19 /NBR</p> | 85) | <p>042-01-0095</p>  | <p>AXLE WASHER 530085 WT4010 AP4010 ID : 1 1/2" x 1 3/8"</p> |
| 86) | <p>042-01-0096</p>  | <p>AXLE END LOCK WASHER AJA-0407-001 448061 AXA04081 ø89x128.5x6</p> | 87) | <p>042-01-0097</p>  | <p>LOCK PLATE 355 356 0173 id:83,Od:126</p> |
| 88) | <p>042-01-0098</p>  | <p>AXLE TAG WASHER ALA18701 WT4064 AP4005 I.D. 3 1/2" O.D. 4 1/4"</p> | 89) | <p>042-01-0099</p>  | <p>AXLE NUT AP4002 ID:85, THK:29, A/F:122mm</p> |

WASHER



| SR. NO. | TRUSTTEC NO. | PART NO. | SIZE Id x Od x Thk | |
|---------|--------------|-------------------------|-----------------------|---|
| 1) | 042-01-0100 | UXA0002 | 1.060x2.500x0.250mm | 1 |
| 2) | 042-01-0101 | UXA0356002 | 2.060x4.000x0.063mm | 1 |
| 3) | 042-01-0102 | | 42.00x64.00x1.50mm | 1 |
| 4) | 042-01-0103 | CF100356 AJA0349/002 | 39.00x60.00x1.50mm | 1 |
| 5) | 042-01-0104 | AJA0349/001 | 42.00x58.00x1.50mm | 1 |
| 6) | 042-01-0105 | | 32.00x45.00x12.00mm | 3 |
| 7) | 042-01-0106 | | 1.375x2.375x0.125mm | 2 |
| 8) | 042-01-0107 | CF340021 | 25.00x44.00x4.00mm | 1 |
| 9) | 042-01-0108 | | 17.00x38.00x3.00mm | 1 |
| 10) | 042-01-0109 | | 2.250x3.750x0.063mm | 1 |
| 11) | 042-01-0110 | UXZ 0002 | 27.00x70.00x8.00mm | 3 |
| 12) | 042-01-0102 | CF340099 | 21.00x37.00x2.80mm | 1 |
| | | | | |

CIRCLIPS







| SR. NO. | TRUSTTEC NO. | PART NO. | SIZE Id x Thk | |
|---------|--------------|-----------------------|------------------|---|
| 1) | 042-01-0103 | | 29.60x2.50mm | 1 |
| 2) | 042-01-0104 | | 38.50x1.75mm | 1 |
| 3) | 042-01-0105 | M003109 ESP1004001 | 35.20x1.75mm | 1 |
| 4) | 042-01-0106 | M002890 | 32.20x1.50mm | 1 |
| 5) | 042-01-0107 | CF700011 | 38.50x1.50mm | 1 |
| 6) | 042-01-0108 | | 35.20x1.20mm | 1 |
| 7) | 042-01-0109 | CF103049 | 29.60x1.50mm | 1 |

| | | | | | |
|-----|--|--|-----|--|--|
| 90) | <p>042-01-0110</p>  | <p>AXLE NUT INNER & OUTER ACF18231 WT4063 AP4004 Thread 3.48" - 12</p> | 91) | <p>042-01-0111</p>  | <p>AXLE NUT 6502802F M60X2,RHT, THK :23mm, SW:77</p> |
| 92) | <p>042-01-0112</p>  | <p>AXLE NUT AJA0620001/ M88X2,L:121, W:121, H:29thk:28mm, SW:132</p> | 93) | <p>042-01-0113</p>  | <p>AXLE END NUT 449559 ACE85101 Thread: 3 1/2"-12, Thk:1.359</p> |
| 94) | <p>042-01-0114</p>  | <p>AXLE END NUT 449558 M002564</p> | 95) | <p>042-01-0115</p>  | <p>WHEEL NUT 448076 M22X1.5 RENAULT-2162162 RENAULT- 21623312 AJA0495-001 IVECO - 61597356 RENAULT-5010262935</p> |

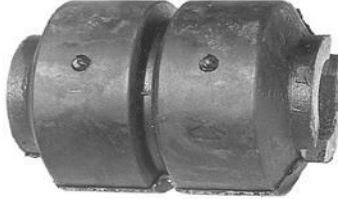
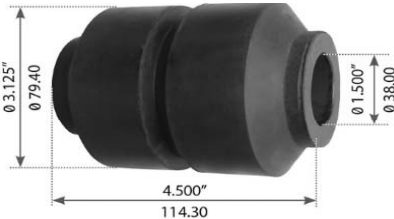

| | | | | | |
|------|--|---|------|--|--|
| 96) | <p>042-01-0116</p>  | <p>WHEEL NUT 21504 M22X1.5, H:35, SW:32</p> | 97) | <p>042-01-0117</p>  | <p>WHEEL NUT AJA0514-001 N1.01105.7261 - MAN 85900014497-MAN 814550300020-MAN 188055- DAF 01121795-IVECO 0252131210-BPW 074361018201-MERCEDES M24X18</p> |
| 98) | <p>042-01-0118</p>  | <p>WHEEL CONE, SPRING 0325235</p> | 99) | <p>042-01-0119</p>  | <p>WHEEL BOLT AJA0491002 74/M22x1,5</p> |
| 100) | <p>042-01-0120</p>  | <p>WHEEL BOLT AJA0491001 ø89xø152,5x40</p> | 101) | <p>042-01-0121</p>  | <p>STUD M069123 M069131</p> |

| | | | | | |
|------|--|--|------|--|--|
| 102) | <p>042-01-0122</p>  | <p>SHOCK ABSORBER, REAR UJB-0364 UJB-0563 UJB-0565 1526855 M001537 ø20x320/470</p> | 103) | <p>042-01-0123</p>  | <p>SHOCK ABSORBER, REAR & FRONT M001022 UJB-0350 ø24x329/494</p> |
| 104) | <p>042-01-0124</p>  | <p>REPAIR KIT, FIFTH WHEEL CR-26722-01 ø31x54/60x89</p> | 105) | | |
| 106) | | | 107) | | |

| | | | | | |
|----|--|--|----|--|---|
| 1) | <p>051-01-0001</p>  | <p>EQUALIZER REYCO - 21725-01 T-5427 E-2846A MERITOR R302846,R302846A EQ001 For 49" Axle Centers</p> | 2) | <p>051-01-0002</p>  | <p>EQUALIZER W/BUSHING Reyco - 09120-01 Reyco -12857-01//20963-01 MERITOR R302843 Mack - 12QDA37 EQ005</p> |
| 3) | <p>051-01-0003</p>  | <p>EQUALIZER REYCO-25222-01 MERITOR - R3010768A EQ027 For 42"- 44" Axle Spacing</p> | 4) | <p>051-01-0004</p>  | <p>EQUALIZER REYCO - 065000/0758000/005800 MERITOR- R304813 Transpro 0650-00 HUTCH- 97800 E-4813 For 49" Axle Centers</p> |
| 5) | <p>051-01-0005</p>  | <p>EQUALIZER REYCO- 08918-01/08996-01/8918-01 MERITOR R302845 EQ007</p> | 6) | <p>051-01-0006</p>  | <p>EQUALIZER ASSEMBLED REYCO - 8996-01 EQ006</p> |

| | | | | | |
|-----|--|--|-----|--|--|
| 7) | <p>051-01-0007</p>  | <p>EQUALIZER REYCO - 12857-01/20963-02 MERITOR R303978 EQ009</p> | 8) | <p>051-01-0008</p>  | <p>EQUALIZER BUSH REYCO - 8363-01/08363-01 TRB 5024</p> |
| 9) | <p>051-01-0009</p>  | <p>EQUALIZER BUSH REYCO - 08915-01 E-2850 TRB5028 id:1 1/4",od:3 1/8",L:4 15/32"</p> | 10) | <p>051-01-0010</p>  | <p>EQUALIZER BUSHING REYCO -08995-01 TRB5025 E-2849 id:1 1/4",od:3 1/8",L:4 7/16"</p> |
| 11) | <p>051-01-0011</p>  | <p>EQUALIZER BUSHING REYCO -14713-01 MERITOR R303977 TRB5029 TRB5029, RT9B</p> | 12) | <p>051-01-0012</p>  | <p>1" SPACER BLOCK, CAST REYCO - T7716/ 24081-01/08778-01 MERITOR R 309563 M83716 SIZE : 3 X 7.5 X 1</p> |

| | | | | | |
|-----|--|--|-----|--|--|
| 13) | <p>051-01-0013</p>  | <p>1.5" SPACER BLOCK, Ductile REYCO - T7654/ 24082-01 MERITOR- R309564 M83654 SIZE : 3 X 7.5 X 1.5</p> | 14) | <p>051-01-0014</p>  | <p>2" SPACER BLOCK, Ductile REYCO - T7655/ 24083-01 MERITOR R 302878 M83655 SIZE : 3 X 7.5 X 2</p> |
| 15) | <p>051-01-0015</p>  | <p>TOP PLATE, "U-Bolts Up REYCO- T5488/T7175 HUTCH 9202-00 M490</p> | 16) | <p>051-01-0016</p>  | <p>TOP PLATE, "U-Bolts Down REYCO-0867701</p> |
| 17) | <p>051-01-0017</p>  | <p>TORQUE ARM / AXLE SEAT HEX BOLT, REYCO - 0001-08 7/8"-14 , 5 1/4"</p> | 18) | <p>051-01-0018</p>  | <p>EQUALIZER HEX BOLT REYCO - 0001-14 MERITOR - R304830 M4886 1"-14, 6 1/2"</p> |

| | | | | | |
|---|-------------|---|-----|-------------|--------------------------------|
| 19) | 051-01-0019 | TORQUE ARM / AXLE SEAT HEX BOLT REYCO - 1003301 7/8"-9, 5 1/2" | 20) | 051-01-0020 | WEAR PLATE REYCO - 15630-01 |
|  | |  | | | |

TORQUE ARM, NON-ADJUSTABLE, BUSHING INCLUDED

Non-Adjustable Torque Arm Assemblies 7/8" Bolt, One Piece Bushing

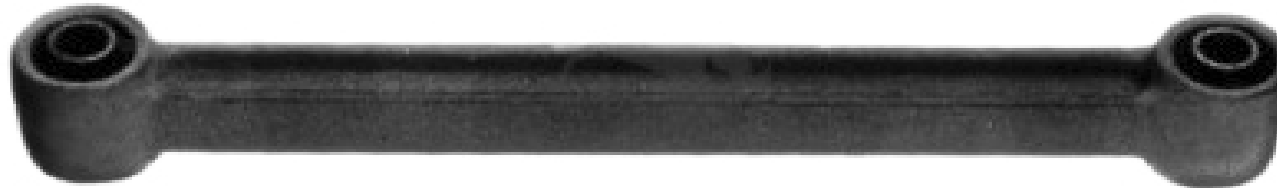

| SR. NO. | TRUSTTEC NO. | PART NO. | | SIZE | APPLICATIONS / INTERCHANGE INFORMATION |
|---------|--------------|---|--|-----------|--|
| 1) | 051-01-0021 | 0075-20 E-4825 Meritor R304825 TR010 | | 19 15/16" | Transpro 86, 88. |

TORQUE ARM, NON-ADJUSTABLE, BUSHING NOT INCLUDED
Non-Adjustable Torque Arm Assemblies 1" Bolt, 2 Piece Bushing



| SR. NO. | TRUSTTEC NO. | PART NO. | SIZE | APPLICATIONS / INTERCHANGE INFORMATION |
|---------|--------------|--|---------|--|
| 1) | 051-01-0022 | 0856701 | 13 3/4" | 21B Suspension, 44" AC, (Front Axle) |
| 2) | 051-01-0023 | 1517801/T-7635 MERITOR R302855 TR031 | 16 1/4" | 21B Suspension, T7635 |
| 3) | 051-01-0024 | 1517901 E2856 T-2293 TR032 | 18 7/8" | 21B Suspension |

TORQUE ARM, ADJUSTABLE, BUSHINGS NOT INCLUDED

Adjustable Torque Arm Assemblies 1" Bolt, 2 Piece Bushing



| SR. NO. | TRUSTTEC NO. | PART NO. | SIZE | APPLICATIONS / INTERCHANGE INFORMATION |
|---------|--------------|--|--------------------|--|
| 1) | 051-01-0025 | 1517101 | 13 3/4" to 15 1/2" | 44" Axle Centers, -(Front Axle) |
| 2) | 051-01-0026 | 1517201//T5485/T5541 MERITOR R303283A TR001 | 15 1/2" to 17 1/2" | 42-44" Axle Centers, T5485, E3283A |
| 3) | 051-01-0027 | 1517301/T5486 MERITOR R303284A TR002 | 17 1/2" to 19 1/2" | 49" Axle Centers, T5486, E3284A |
| 4) | 051-01-0028 | 1517401/1535401/T5487 VOLVO - 358010079 HUTCH - 24507 TR058 | 19 1/2" to 21 3/4" | 50" Axle Centers, T5487, E2295 |





TORQUE ARM, ADJUSTABLE, BUSHING INCLUDED

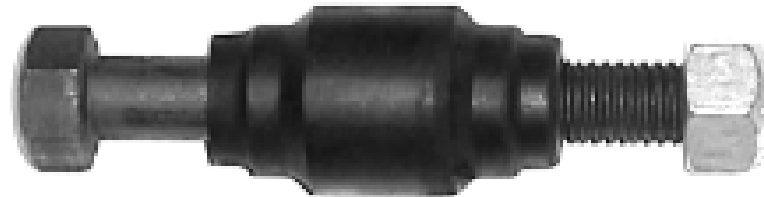

| SR. NO. | TRUSTTEC NO. | PART NO. | SIZE | APPLICATIONS / INTERCHANGE INFORMATION |
|---------|--------------|--|-----------------|--|
| 1) | 051-01-0029 | 1634701/16347014/T3683/T3036 HENDRICKSON - C1031/S10332 HUTCH- 16347-01 MERITOR- R 302512/ R303773 TR061 | 14 3/4" to 18" | Susp models 45, 102, (Cast Ends!) E2512 |
| 2) | 051-01-0030 | 1035-20 TR009 MERITOR- R 304824 HENDRICKSON- S-103201-1 | 19 7/8" | Reyco Transpro 86, 88. 16349-01, E2513 |
| 3) | 051-01-0031 | 16349-01 HENDRICKSON S-1032-1 MERITOR R302513 TR009/TR062 | 18 1/4"-21 1/2" | |





TORQUE ARM BUSHING KIT

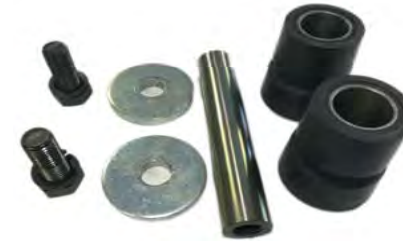

| SR. NO. | TRUSTTEC NO. | PART NO. | APPLICATIONS / INTERCHANGE INFORMATION |
|---------|---|--|---|
| |  | Reyco E4834A Reyco NL3013 Reyco 101A TK16656 MERITOR R304834A | |
| 1) |  | TORQUE ARM BOLT E4833 NL3014 MERITOR - R 304833 C780512 7/8-14 LONG | 2)  |
| | | | TORQUE ARM BUSHING REYCO - 9729-01/T3016 NL3015 Id: 1 7/8", Od:1.937" , L:3" E1980 E7750 TRB6004 |
| 3) |  | Lock Nut HUTCH - 10562-00 NL3016 E9607 E2983 1-14 Thread, 1-7/16 Hex, 7/8 Height | 4) |

EQUALIZER BUSHING KIT













| SR. NO. | TRUSTTEC NO. | PART NO. | APPLICATIONS / INTERCHANGE INFORMATION |
|---------|--|---|---|
| | 051-01-0036 | REYCO -TK-18998 BWP2936 M MERITOR 303976 MERITOR R 309555 TRK 5066 | |
| 1) | 051-01-0037  | EQUALIZER BUSHING Id:1.625", Od: 2.750", L:4.437" REYCO - T5524 MERITOR 301195 TRAILMOBILE - 156571 | 2) 051-01-0038  EQUALIZER SHAFT REYCO 1424701/T888 E3972 M1721 TRS4003 |
| 3) | 051-01-0039  | COMPRESSION WASHER ID:1", Od:3.75" , Thk:0.500 REYCO - 1424901 E1986A / T5887 M1720 | 4) 051-01-0040 LOCK WASHER, EQUALIZER SHAFT 1X1.705" REYCO - 1425001 |
| 5) | 051-01-0041  | Cap Screw, Equalizer Shaft 1"x2/ 1/2" REYCO - 1424801 | |







TORQUE ARM BUSHING KIT









| TRUSTTEC NO. | PART NO. | APPLICATIONS / INTERCHANGE INFORMATION |
|--------------|---|---|
| 051-01-0042 | REYCO -TK18997 / TK7319/ TK16658 MERITOR - R 30132A TRK 60008 | |
| 1) | <p>051-01-0043</p>  <p>TORQUE ARM BUSHING ID: 1" , Od1: 1-13/16", Od2: 2-3/8" REYCO - T5493 E1160 TRB 6008 MERITOR - R 301160</p> | <p>2)</p> <p>051-01-0044</p>  <p>COMPRESSION WASHER 1x2.75" T2224</p> |
| 3) | <p>051-01-0045</p>  <p>LOCK NUT Hex1-14unsgr.c REYCO - T5495</p> | <p>4)</p> <p>051-01-0046</p>  <p>TORQUE ARM BOLT 1-14x7" REYCO - T5492</p> |



| | | | | | |
|----|--|--|----|--|---|
| 1) | <p>052-01-0001</p>  | <p>EQUALIZER W/BUSHING Trailmobile 3-A66-43 Meritor R303383 E-3383 EQ024</p> | 2) | <p>052-01-0002</p>  | <p>EQUALIZER BOLT ASSY Trailmobile 700-7-155 E-3393 TRK5496</p> |
| 3) | <p>052-01-0003</p>  | <p>ADJUSTABLE TORQUE ROD Trailmobile 3-A11-65A HUTCH 713-10 REYCO 065417 HUTCHENS 16398-17 HENDRICKSON 1639817 MERITOR R303390 TR007</p> | 4) | <p>052-01-0004</p>  | <p>TORQUE ROD,ADJUSTABLE WITH BUSHING,CTC 19 3/8" Trailmobile 3-A11-74G MERITOR R303405 TR478</p> |
| 5) | <p>052-01-0005</p>  | <p>TORQUE ROD-RIGID (BUSHED) Trailmobile 3-A11-64 TR008</p> | 6) | | |



| | | | | | |
|----|--|--|----|--|---|
| 1) | <p>053-01-0001</p>  | <p>END BEAM BUSHING HENDRICKSON</p> | 2) | <p>053-01-0002</p>  | <p>BEAM BUSHING Hendrickson:S21307 17993 TRB 5922 id:1.13", od:6.0" Overall Length :6.74</p> |
| 3) | <p>053-01-0003</p>  | <p>BEAM END BUSHING (M1976) Hendrickson 6969 Navistar 3213596R1, Volvo 498417, Navistar 124865R91, GM232597 OD:4 3/8",ID:2 1/2" , L:5 1/4"</p> | 4) | <p>053-01-0004</p>  | <p>BEAM END BUSHING (M1970) Hendrickson 45900 Volvo 425836, Volvo 452836, Hendrickson 6572, Volvo 35033-5003 OD:4 3/8",ID:2 1/2" , L:5 3/4" OD:4 3/8",ID:2 1/2" , L:6" OD:6",ID:3" , L:6" OD:8 1/2",ID:3 1/2" , L:7 3/4"</p> |
| 5) | <p>053-01-0005</p>  | <p>BEAM BUSHING HE-10366 HN-3094 HE1031 H-10366-000 SC1320 2445951 233431R91 882997 C873 E-2553 09-5470 10366 M-2091</p> | 6) | <p>053-01-0006</p>  | <p>BEAM END ADAPTOR KIT Hendrickson 21140-34 HAK112</p> |



| | | | | | |
|-----|--|---|-----|--|--|
| 7) | <p>053-01-0007</p>  | <p>BEAM END ADAPTOR KIT Hendrickson 21140-7 Navistar 593717C91 HAK124</p> | 8) | <p>053-01-0008</p>  | <p>BEAM END ADAPTOR KIT Hendrickson 45000-13 HAK92</p> |
| 9) | <p>053-01-0009</p>  | <p>BEAM END BUSHING ADAPTOR KIT PART NO:19880/1349400 HAK100</p> | 10) | <p>053-01-0010</p>  | <p>BUSH ADAPTOR KIT HENDRICKSON - 34013-049</p> |
| 11) | <p>053-01-0011</p>  | <p>LOAD CUSHION Hendrickson 48972</p> | 12) | <p>053-01-0012</p>  | <p>LOAD CUSHION Hendrickson 48973 Hendrickson 9047 Volvo 683671 GM 2423369 Navistar 427893R1 Navistar 429284R1</p> |







| | | | | | |
|-----|--|---|-----|--|---|
| 13) | <p>053-01-0013</p>  | <p>2 PIECE TORQUE ROD - MALE, 27" Hendrickson : 46660, 46661, 66660-000H, 66661-000H Freightliner: IPC928660, IPC928661 Automann :TMRU660, TMRU661 International :1693536C1, 1693537C1 Meritor :R3010315, R302642 Volvo :35801-5012</p> | 14) | <p>053-01-0014</p>  | <p>2 PIECE TORQUE ROD END Hendrickson 46681/50234-A 52288-A/52288000A/66681/ 50234000A TMR681 L: 22 1/2", THREAD : 1 1/4"-12</p> |
| 15) | <p>053-01-0015</p>  | <p>2 PIECE TORQUE ROD END Hendrickson # 46610 / 66610 IHC # 1693531C1 Neway # 90044635 TMRU610</p> | 16) | <p>053-01-0016</p>  | <p>TORQUE ROD BUSHING Hendrickson 69210 / 69210-000 69210-000H, 069210-000 69210000, 69210000H, 069210000 E-10322 TRB6175</p> |
| 17) | <p>053-01-0017</p>  | <p>TORQUE ROD BUSHING, IN PU, Blue color Hendrickson:47691000 A16-119448 MACK:47691 Peterbilt:47691 #TRB6185 CTC:4.375",HOLE DIA:0.6875" W:2.0625",L:6.625"</p> | 18) | <p>053-01-0018</p>  | <p>TORQUE ROS BUSH (RUBBER) Hendrickson:47691000 A16-119448 MACK:47691 Peterbilt:47691 #TRB6185UB CTC:4.375",HOLE DIA:0.6875", W:2.0625",L:6.625"</p> |

| | | | | | |
|-----|--|--|-----|--|--|
| 19) | <p>053-01-0019</p>  | <p>TORQUE ROD BUSHING Hendrickson 44695, 44695000 44695-000, 227720 Navistar 1693060C1, 484680C1 Kenworth 227720G Volvo 35807-5001 Neway 57750255 Meritor A-2297-Y-77A TRB6820</p> | 20) | <p>053-01-0020</p>  | <p>TORQUE ROD BUSHING Hendrickson 46734, MTC 46734-000, Neway 57750261 / 1693070C1 TRB6118</p> |
| 21) | <p>053-01-0021</p>  | <p>TORQUE ROD BUSHING HENDRICKSON 47691 TRB 6185</p> | 22) | <p>053-01-0022</p>  | <p>TORQUE ROD BUSHING Hendrickson 44809 Neway 57750230 TRB6116</p> |
| 23) | <p>053-01-0023</p>  | <p>TORQUE ROD BUSHING Hendrickson 46737 Neway 5775023 TRB6117</p> | 24) | <p>053-01-0024</p>  | <p>TORQUE ROD BUSHING Hendrickson 46735 Neway 57750232 TRB6119</p> |

| | | | | |
|-----|--|---|-----|--|
| 25) | <p>053-01-0025</p>  | <p>TORQUE ROD BUSHING Hendrickson 44697000 / 44697-000, 44697 Navistar 1693066C1 Volvo 35801-5016 TRB6112</p> | 26) | <p>053-01-0026</p>  <p>SILENT BLOCK BUSHING Hendrickson 52272/52276 Kenworth: B651006, B65-1017-001 Peterbilt: b65-1006 #MR 836 id: 1 1/16", od: 1 3/4", L1: 4 1/16", L2: 6 5/16", L3: 7 1/2"</p> |
|-----|--|---|-----|--|





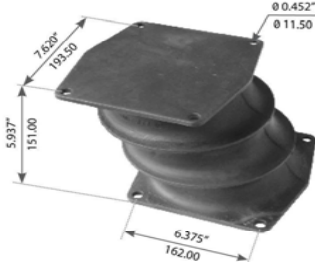

| | | | | |
|-----|--|---|-----|--|
| 27) | <p>053-01-0027</p>  | <p>CENTER BUSHING HENDRICKSON 5919000</p> | 28) | <p>053-01-0028</p>  <p>CENTER BUSHING Hendrickson 6664 Volvo 498403 Navistar 965080R1 / 965080R91 124864R1 / 124864R91 GM 2325972 M1974</p> |
|-----|--|---|-----|--|







| | | | | |
|-----|--|--|-----|---|
| 29) | <p>053-01-0029</p>  | <p>CENTER BUSHING Hendrickson 34013-97 M1972</p> | 30) | <p>053-01-0030</p>  <p>CENTER BUSHING HENDRICKSON 30240-002 id: 3.50", od: 4.750", L: 5.875"</p> |
|-----|--|--|-----|---|

| | | | | |
|------------|--|---|---|---|
| <p>31)</p> | <p>053-01-0031</p>  | <p>CENTER BUSHING KIT HENDRICKSON 30437000L MERITOR R301546 HBK 100</p> | <p>32)</p> <p>053-01-0032</p>  | <p>BALL+BUSHING ASSY HENDRICKSON 31013-057 MHEB4</p> |
| <p>33)</p> | <p>053-01-0033</p>  | <p>BRONZE END KIT Hendrickson 34013-57 / 30625-7 Navistar 597319C91 Volvo 3120338A MHS36257</p> | <p>34)</p> <p>053-01-0034</p>  | <p>Hendrickson : 06813000, 353702 GMC :131046, 137826, 2014467 International :3213567R1, 891237R1 Meritor :R309429 Midland :CQ70610 Volvo / White r:27092621, 718850 AUTOMANN 35370-002</p> |
| <p>35)</p> | <p>053-01-0035</p>  | <p>SADDLE CAP STUD ASSY Meritor R301830 / R301834/ R301835 MSK460 7/8-14 X 4.88".</p> | <p>36)</p> <p>053-01-0036</p>  | <p>BI-METAL BUSHING Hendrickson 37992 / 64593-000 16-12399-001 1 1/2:idx1 1/4"odx4"</p> |







| | | | | | |
|------------|--|---|------------|---|---|
| <p>37)</p> | <p>053-01-0038</p>  <p>Bolt Hole: 0.438"</p> | <p>BOLSTER SPRING Model HN522 5.625 X 5.500 X 6.875- BOLT HOLE 0.438 Hendrickson - HN402/462(3/96-9/97)</p> | <p>38)</p> | <p>053-01-0039</p>  | <p>SPRING EYE BUSH HENDRICKSON - 58648000</p> |
|------------|--|---|------------|---|---|







| | | | | | |
|--|--|--|--|--|--|
| | | | | | |
|--|--|--|--|--|--|







| | | | | | |
|----|--|--|----|--|---|
| 1) | <p>054-01-0001</p>  | <p>LEAF SPRING EQUALIZER Hutch H-7600, H-7700, 75003 H, CH7600 / H, CH7700 42-1/2 inch-49 TRB5541</p> | 2) | <p>054-01-0002</p>  | <p>HUTCH CAST EQUALIZER W/BUSHING 7700S SUSPENSION Hutch 19137-01 / 24367-01 Midwest WA12-5018, Hutchens 704-01 Meritor R302889</p> |
| 3) | <p>054-01-0003</p>  | <p>CAST EQUALIZER Hutch Number:1778401, 1629001 Automann Number:EQ028 Dayton Number:338-887 Euclid Number:E-9471 Flagg Number:H225, H225I Meritor Number:R309471</p> | 4) | <p>054-01-0004</p>  | <p>EQUALIZER Includes SH1008 E-1999A Bushing Hutch H-7600 / H-7700 Fruehauf: SHU-750003</p> |
| 5) | <p>054-01-0005</p>  | <p>CENTER HANGER Hutchens H-7700 / H-9700 Hutchens 7702-01, Meritor R302911 M8290</p> | 6) | <p>054-01-0006</p>  | <p>FRONT HANGER Hutchens 7701-01 Hutchens H-7700 / H-9700 Meritor R302910A M8288</p> |



| | | | | | |
|-----|--|---|-----|--|---|
| 7) | <p>054-01-0007</p>  | <p>REAR HANGER Hutchens 7703-01 Hendrickson 52897, 52897-000S, 52897000S Meritor R302912A M8292</p> | 8) | <p>054-01-0008</p>  | <p>FRONT HANGER Hutch 20728-01 Hutchens 7701-02 Hutchens H-7700 / CH-9700 Euclid E-2913A Meritor R302913A M8294</p> |
| 9) | <p>054-01-0009</p>  | <p>CENTER HANGER Hutchens 7702-02 Hutchens H-7700</p> | 10) | <p>054-01-0010</p>  | <p>REAR HANGER Hutch 20732-01 Meritor R302915A Hutchens 7703-02 Hutchens H-7700 / H-9700. M8298</p> |
| 11) | <p>054-01-0011</p>  | <p>FRONT HANGER,STRADDLE MOUNT Hutch 7601-01 MERRITOR R309493 M21457</p> | 12) | <p>054-01-0012</p>  | <p>CENTER HANGER,STRADDLE MOUNT Hutch 7602-01, Meritor R309495 M21458</p> |

| | | | | | |
|-----|--|---|-----|--|--|
| 13) | <p>054-01-0013</p>  | <p>CENTER HANGER,STRADDLE MOUNT Hutch 16187-01, Meritor R309497 Hutch 16178-01 M16178</p> | 14) | <p>054-01-0014</p>  | <p>FRONT HANGER,UNDER MOUNT Hutch 20725-01, Hutch 7601-02 Meritor R309494 M21456</p> |
| 15) | <p>054-01-0015</p>  | <p>CENTER HANGER,UNDER MOUNT Hutch 7602-02 Meritor R309496 M21460</p> | 16) | <p>054-01-0016</p>  | <p>CENTER HANGER,UNDER MOUNT Meritor R309498, Hutch 16188-01 M21453</p> |
| 17) | <p>054-01-0017</p>  | <p>CENTER STRADDLE MOUNT HANGER MERITOR R307534 Hutchens 16169-01 M8095</p> | 18) | <p>054-01-0018</p>  | <p>CENTER MOUNT HANGER Meritor R309582 Hutchens 16171-01, M8097</p> |

| | | | | | |
|------------|--|---|------------|--|--|
| <p>19)</p> | <p>054-01-0019</p>  | <p>SPRING SEAT 5" ROUND HUTCH 1936001 / 2221501 MERITOR R302908 M8284</p> | <p>20)</p> | <p>054-01-0020</p>  | <p>AXLE SEAT 5" Round Axle, 1-3/4 Rise. Hutch 19360-03 Hutch 705-03 M17714</p> |
| <p>21)</p> | <p>054-01-0021</p>  | <p>EQUALIZER BOLT KIT Hutchens 759-00 Contains Two SH1011 E-2002 Nuts, Two SH1045 E-3415 Rebound Bolts, Two SH1046 E-3416 Spacer Sleeves, One SH1054 E-7533 Bolt, One SH1055 E-4358, Nut, And Two SH1062 E-2548 Washers.</p> | <p>22)</p> | <p>054-01-0022</p>  | <p>EQUALIZER BOLT KIT Hutchens 10287-01, Hutchens H-7600 / H-7700 / H-2200 Contains Two SH1009 E-2000 Step Bolts, One SH1010 E-2001 . Tab Lock, Four SH1011 E-200 2 Nuts, Two SH1045 E-3415 s Rebound Bolts, And Two SH1046 E-3416 Spacer Sleeve</p> |
| <p>23)</p> | <p>054-01-0023</p>  <p>5/8" x 14 UNF A/F .000" 0.500" 6.000" 1.000"</p> | <p>EQUALIZER BOLTS Hutchens 7016-01 Fruehauf UCA-0469 TRS4413 SET OF 4 PCS</p> | <p>24)</p> | <p>054-01-0024</p>  | <p>TAB LOCK Hutchens 729-00 Meritor R302001 MH456</p> |





| | | | | | |
|-----|--|--|-----|--|--|
| 25) | <p>054-01-0025</p>  | <p>TORQUE ROD Hutch 16398-01 Hutch 713-01 TR011</p> | 26) | <p>054-01-0026</p>  | <p>ADJUSTABLE TORQUE ROD ASSY,16" Includes SH1001 E-934 Bushings. 16". Hutchens H-7700 / H-9700 / CH-7700 / CH-9700. Hutchens 713-02 Hutchens 16398-02 TR019</p> |
| 27) | <p>054-01-0027</p>  | <p>ADJUSTABLE TORQUE ROD ASSY,19 1/4" Hutchens 16398-04, Hutchens 713-05 Hutchens H-7700 / H-9700 / CH-7700 / CH-9700.</p> | 28) | <p>054-01-0028</p>  | <p>ADJUSTABLE TORQUE ARM,17 1/4" Includes SH1001 E-934 Bushings. Hutch 71310 Hendrickson 1639817 Meritor R303390 TR007</p> |
| 29) | <p>054-01-0029</p>  | <p>TORQUE ROD Hutch 16398-06 Hutch 713-07, Hutch 16398-05, Hutch 16398-06 Meritor R3011448 TR025</p> | 30) | <p>054-01-0030</p>  | <p>TORQUE ROD Hutch 16398-08, Hutch 713-11. Meritor R307684 TR71311</p> |



| | | | | | |
|-----|--|---|-----|--|---|
| 31) | <p>054-01-0031</p>  | <p>TORQUE ROD Hutch 16399-01, Hutch 2213-00 ØR21300</p> | 32) | <p>054-01-0032</p>  | <p>ADJUSTABLE TORQUE ARM, 19 1/4" Without Bushings. Takes E-9478 Bushing Kit. 19-1/4" Center To Center Hutch 16167-04, Hutch 7615-12, TR040</p> |
| 33) | <p>054-01-0033</p>  | <p>RIGID TORQUE ARM, 19 1/4" Includes SH1001 E-934 Bushings Hutchens 715-00 Hutchens H-7700 / H-9700 / CH-7700 / CH-9700 TR005</p> | 34) | <p>054-01-0034</p>  | <p>TORQUE ROD Hutch 11953-01, Hutch 7615-02, Meritor R309477 TR041</p> |
| 35) | <p>054-01-0035</p>  | <p>TORQUE ARM BOLT 1-14 Thread X 5" Long Hutchens 719-02 Hutchens H-7700 / H-9700 / CH-7700 / CH-9700. Meritor R302891 TRS6326 SET OF 4</p> | 36) | <p>054-01-0036</p>  | <p>TORQUE ARM NUT 1-14 Thread, 1-7/16 Hex, 7/8 Height Hutchens 10562-00 Meritor R302892 FLN107</p> |



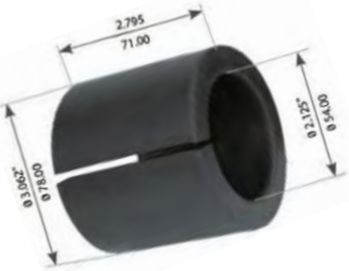



| | | | | | |
|-----|--|--|-----|--|--|
| 37) | <p>054-01-0037</p>  | <p>EQUALIZER BUSH Hutchens 16353-01, Hutchens H-9600 / H-9700 / CH-9600 / CH-9700 Meritor R309475 NAVISTAR 497501C2T TRB5169 1"idx120x63.5mm</p> | 38) | <p>054-01-0038</p>  | <p>ENGINE MOUNTING BUSH Navistar 503579C1 Volvo 12004-0007 M20304 id:1 1/2",od:3",H:3"</p> |
|-----|--|--|-----|--|--|





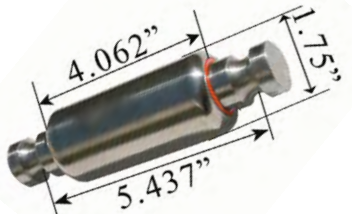

| | | | | | |
|-----|--|--|----|--|--|
| 39) | <p>054-01-0039</p>  | <p>RUBBER SPRING PAD Hutch 814-00 M12922</p> | 4) | | |
|-----|--|--|----|--|--|

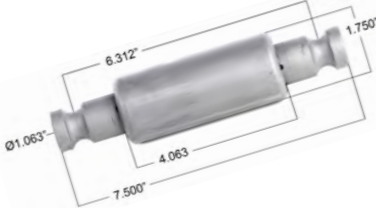

| | | | | | |
|--|--|--|--|--|--|
| | | | | | |
|--|--|--|--|--|--|

| | | | | | |
|----|---|--|----|--|---|
| 1) | <p>055-01-0001</p>  <p>15.000" 13.438" Equalizer Hole: Ø1.625"</p> | <p>EQUALIZER KENWORTH K034-144/K034-058 EQ0116</p> | 2) | <p>055-01-0002</p>  | <p>KENWORTH BRACKET Kenworth K272-145 MK16913</p> |
| 3) | <p>055-01-0003</p>  | <p>KENWORTH AIR RIDE MOUNT k066-449 id:1 7/8",od:3"</p> | 4) | <p>055-01-0004</p>  | <p>KENWORTH REAR STB BUSHING K066450 id:2.125",od:3.062",W:2.795"</p> |
| 5) | <p>055-01-0005</p>  | <p>RADIATOR MOUNT, INTERNATIONAL KENWORTH-K066-336 66001-3043 PART # T 1633 M30473 M1741 ID:11/16",OD1:1 15/16",OD2:2 15/16"</p> | 6) | <p>055-01-0006</p>  | <p>Mount Kit Lower Front,w/hardware Kenworth 066-2423, 066-406 Kenworth 066-385, 066-405, 066-423 Ht:2.14",id:0.79",od:2",W:2.75" M203041 REBOUND WASHER id:0.520mm,od:3" M203039+M203041</p> |



| | | | | | |
|-----------|--|---|------------|---|--|
| <p>5)</p> | <p>055-01-0007</p>  | <p>Motor Mount Kit Front,W/hardware KT59-62002-HW K066-423 Ht:1 3/16"(upper)/ht:1/2"(lower) id:13/16",od1:2",od2:3 1/4" Kenworth:K066-404(LOWER) T-600W/900(front) K066-046(upper)</p> | <p>6)</p> | <p>055-01-0008</p>  | <p>Motor Mount Kenworth,with hardware Kenworth:K066-377/K066-421 2each-Lower Motor Mount 2each:Uppet Motor Mount 2each:Cap Screw 20mm-2.5x120mm 2each:Nyloc nut Metric 4each:Hardened Washers MM59-62001</p> |
| <p>7)</p> | <p>055-01-0009</p>  | <p>KENWORTH TORSION BAR PIN KIT Kenworth K179531, K179-531 Kenworth K345-5156, K3455032, K3455156 MK16931</p> | <p>8)</p> | <p>055-01-0010</p>  | <p>HOOD MOUNT Kenworth:K179-528 # HML59.64010 L:3",od1:1",od2:1 1/2", Stud size:5/16"-24x1 3/4"</p> |
| <p>9)</p> | <p>055-01-0011</p>  | <p>TORQUE ROD BUSH 836940 / 839310 # TRB 6825 od:2 3/4",CTC:4 3/8"</p> | <p>10)</p> | <p>055-01-0012</p>  <p>3.187" 3.863" Thread 1/2" -13</p> | <p>HOOD GUIDE BUSHING Kenworth:K179-450/K179D-450 K179-528 MERITOR R307467 # M17402UB</p> |





| | | | | | |
|----|--|--|----|--|--|
| 1) | <p>046-01-0001</p>  | <p>TORQUE ROD,25 3/8" C656013000000649 NAVISTAR 3548381C1/ 501565C2/3580088C1 FORD 4C4Z4264CA MACK 17QF358P9 TMR533 Peterbilt,Kenworth</p> | 2) | <p>046-01-0002</p>  | <p>TORQUE ROD,25.56", Heavy Duty,with reinforced 45mm Rod C656013000000649 NAVISTAR 3548381C1/ 501565C2/3580088C1 FORD 4C4Z4264CA MACK 17QF358P9 TMR533</p> |
| 3) | <p>046-01-0003</p>  | <p>TORQUE ROD BUSH 02-27720 / 227720 Volvo - 35807-5001 KENWORTH B651006 MACK:1688-227720 Hendrickson:44695/44695000 od:2 3/4",CTC:4 3/8" # TRB 6820</p> | 4) | <p>046-01-0004</p>  | <p>TORQUE ROD BUSH 02-27720 / 227720 Volvo 35807-5001 KENWORTH B651006 MACK:1688-227720 Hendrickson:44695/44695000 od:2 3/4",CTC:4 3/8" # TRB 6820</p> |
| 5) | <p>046-01-0005</p>  | <p>KW BUSHING PETERBILT B65-6005 DAYTON RB-328 KENWORTH B656005 HENDRICKSON 52375 #MR 902 id:1 1/16",od:1 3/4",L1:4 1/16" ,L2:5 7/16",L3:6 11/16"</p> | 6) | <p>046-01-0006</p>  | <p>KW BUSHING PETERBILT B65-1001 HENDRICKSON 52321 DAYTON RB-249 Kenworth B65-1001 #MR 744 id:1 1/16",od:1 3/4" L1:4 1/16",L2:5 3/4",L3:7 1/8"</p> |



| | | | | | |
|-----|--|--|-----|--|--|
| 7) | <p>046-01-0007</p>  | <p>KW BUSHING PETERBILT B65-1017-001/ B65-1006 Hendrickson:52272/52256 Kenworth:B651006/B65-1017-001 DAYTON RB-295 #MR 836 id:1 1/16",od:1 3/4",L1:4 1/16", L2:6 5/16",L3:7 1/2"</p> | 8) | <p>046-01-0007</p>  | <p>Bi-METAL BUSH SPRING PIN Peterbilt:01-29966 Peterbilt:01-01766 Peterbilt:02-01848 16-01005-00 Freightliner:16-01005 MPB58/OGB-RNI ID:1 1/4"Xod:1 1/2"L:3 1/2" OGB-RNI</p> |
| 9) | <p>046-01-0008</p>  | <p>RADIATOR BUSHING PETERBILT 13-03096 #M17484UB #M13309 ID: 0.387", L:1.000"</p> | 10) | <p>046-01-0009</p>  | <p>MOTOR MOUNT Peterbilt:05-62401 Freightliner:LOR CB1125 2 Freightliner:M700 50NR M17475</p> |
| 11) | <p>046-01-0010</p>  | <p>HOOD BUMPER Peterbilt 13-04711 #M13353UB Dimensions: 2 3/8" outside; 2" inside 3 1/8" outside; 2 1/4" inside 2" outside; 1 9/16" inside</p> | 12) | <p>046-01-0011</p>  | <p>AIR LEAF THRUST ANGLE SHIM 1/32" 1/16" 1/8"</p> |



| | | | | | |
|-----------|--|---|-----------|--|--|
| <p>1)</p> | <p>REQUEST BY SIZE</p>  | <p>Silicon Hose 3 feet x 0.75" id Silicon Hose 3 feet x 1" id Silicon Hose 3 feet x 1.25" id Silicon Hose 3 feet x 1.50" id Silicon Hose 3 feet x 1.75" id Silicon Hose 3 feet x 2" id Silicon Hose 3 feet x 2.25" id Silicon Hose 3 feet x 2.5" id Silicon Hose 3 feet x 2.75" id Silicon Hose 3 feet x 3" id Silicon Hose 3 feet x 3.25" id Silicon Hose 3 feet x 3.50" id Silicon Hose 3 feet x 3.75" id Silicon Hose 3 feet x 4" id Silicon Hose 3 feet x 4.25" id Silicon Hose 3 feet x 4.50" id Silicon Hose 3 feet x 5" id</p> | <p>2)</p> | <p>REQUEST BY SIZE</p>  | <p>Elbow Hose 90 deg 12",id:2.50" Elbow Hose 90 deg 12",id:2.75" Elbow Hose 90 deg 12",id:3" Elbow Hose 90 deg 7"x7",id:2.50" Elbow Hose 90 deg 7"x7",id:2.75" Elbow Hose 90 deg 7"x7",id:3" Elbow Hose 45 deg 18",id:2.50" Elbow Hose 45 deg 18",id:2.75" Elbow Hose 45 deg 18",id:3"</p> |
|-----------|--|---|-----------|--|--|

| | | | | | |
|-----------|--|--|-----------|--|---|
| <p>3)</p> | <p>REQUEST BY SIZE</p>  | <p>CONSTANT TENSION CLAMP, WORM DRIVE TYPE</p> <p>1.19"-2.75" 1.25"-2.13" 1.31"-2.25" 1.56"-2.50" 1.75"-2.63" 2.06"-3" 2.25"-3.13" 2.56"-3.50" 2.75"-3.63" 3.25"-4.13" 3.75"-4.63" 4.25"-5.13" 4.75"-5.63"</p> | <p>4)</p> | <p>REQUEST BY SIZE</p>  | <p>SPRING LOADED T - BOLT CLAMP</p> <p>1 3/4" - 2" 1 7/8" - 2 3/16" 2 1/16" - 3" 2 1/2" X 2 13/16" 2 1/4" X 2 9/16" 2 1/8" X 2 7/16" 2 5/8" - 2 15/16" 3 - 3 5/16" 3 1/4" X 3 9/16" 3 1/8" X 3 7/16" 3 3/4" X 4 1/16" 4 3/4" - 5 1/16" 4" - 4 5 1/6" 4 1/4" - 4 9/16" 5 3/4" - 6 1/16" 7" X 7 5/16"</p> |
|-----------|--|--|-----------|--|---|







| | | | | | |
|-----------|---|---|-----------|--|---|
| <p>5)</p> | <p>REQUEST BY SIZE</p>  | <p>T BOLT CLAMP</p> <p>1 3/4" - 2" 1 7/8 - 2 3/16 2 11/16" X 2 3/8" 2 1/16" - 3" 2 1/2" X 2 13/16 2 1/4" X 2 9/16" 2 1/8" X 2 7/16" 2 3/8" X 2 11/16" 2 5/16 - 2 5/8 2 7/8" X 3 3/16" 3 X 3 5/16" 3 1/4" X 3 9/16", 3 3/4 X 4 1/6 3" X 3 5/16", 4 1/4" - 4 9/16" 4 3/4 - 5 1/6, 4 X 4 5/16 5 3/4" - 6 1/16", 7" X 7 5/16"</p> | <p>6)</p> | <p>REQUEST BY SIZE</p>  | <p>V Band Clamp 3.50" TEXC 350 V Band Clamp 4.00" TEXC 400 V Band Clamp 5.00" TEXC 500</p> |
|-----------|---|---|-----------|--|---|

| | | | | | | | | | | | | | | | | | | | | | |
|---------|--|--|-----|--|--|---------|-------------|-------|-------------|---------|-------------|-------|-------------|---------|-------------|-------|-------------|---------|-------------|-------|-------------|
| 7) | <p>056-01-0001</p>  | <p>AIR SENSOR UNV STERLINGS 70 PSI NC #5919 SENSOR</p> | 8) | <p>056-01-0002</p>  | <p>AIR SENSORS 70 PSI CAP NO #5918 SENSOR</p> | | | | | | | | | | | | | | | | |
| 9) | <p>056-01-0003</p>  | <p>AIR SENSORS 4 PSI NO CLOSE W/RED COVER ON THREADS NC TYPE 4PSI #5917 SENSOR</p> | 10) | <p>056-01-0004 056-01-0005 056-01-0006</p>  | <p>Hardened Washer OD:1 1/4" X ID: 5/8" X Thickness 1/8" Hardened Washer OD:1 1/4" X ID: 5/8" X Thickness 1/16" Hardened Washer OD:1 1/4" X ID: 5/8" X Thickness 1/32"</p> | | | | | | | | | | | | | | | | |
| 11) | <p>056-01-0007 056-01-0008 056-01-0009</p>  | <p>CASTOR SHIM - 1/32" CASTOR SHIM - 1/16" CASTOR SHIM - 1/8"</p> | 12) |  | <p>HEAVY DUTY TRUCK CASTOR WEDGE,Length:53/4" UNI-WEDGE ALUMINIUM SHIMS DEG:</p> <table border="0"> <tr> <td>1/2 DEG</td> <td>056-01-0010</td> </tr> <tr> <td>1 DEG</td> <td>056-01-0011</td> </tr> <tr> <td>1.5 DEG</td> <td>056-01-0012</td> </tr> <tr> <td>2 DEG</td> <td>056-01-0013</td> </tr> <tr> <td>2.5 DEG</td> <td>056-01-0014</td> </tr> <tr> <td>3 DEG</td> <td>056-01-0015</td> </tr> <tr> <td>3.5 DEG</td> <td>056-01-0016</td> </tr> <tr> <td>4 DEG</td> <td>056-01-0017</td> </tr> </table> | 1/2 DEG | 056-01-0010 | 1 DEG | 056-01-0011 | 1.5 DEG | 056-01-0012 | 2 DEG | 056-01-0013 | 2.5 DEG | 056-01-0014 | 3 DEG | 056-01-0015 | 3.5 DEG | 056-01-0016 | 4 DEG | 056-01-0017 |
| 1/2 DEG | 056-01-0010 | | | | | | | | | | | | | | | | | | | | |
| 1 DEG | 056-01-0011 | | | | | | | | | | | | | | | | | | | | |
| 1.5 DEG | 056-01-0012 | | | | | | | | | | | | | | | | | | | | |
| 2 DEG | 056-01-0013 | | | | | | | | | | | | | | | | | | | | |
| 2.5 DEG | 056-01-0014 | | | | | | | | | | | | | | | | | | | | |
| 3 DEG | 056-01-0015 | | | | | | | | | | | | | | | | | | | | |
| 3.5 DEG | 056-01-0016 | | | | | | | | | | | | | | | | | | | | |
| 4 DEG | 056-01-0017 | | | | | | | | | | | | | | | | | | | | |

| | | | | | | | | | | | | | | | | | | | | | |
|---------|---|---|--------|-------------|--------|-------------|--------|-------------|--------|-------------|--------|-------------|--------|-------------|---------|-------------|---------|-------------|-----|--|--|
| 13) |  | <p>OIL SEAL</p> <table border="0"> <tr><td>#47691</td><td>056-01-0018</td></tr> <tr><td>#35058</td><td>056-01-0019</td></tr> <tr><td>#46300</td><td>056-01-0020</td></tr> <tr><td>#46300</td><td>056-01-0021</td></tr> <tr><td>#35066</td><td>056-01-0022</td></tr> <tr><td>#42623</td><td>056-01-0023</td></tr> <tr><td>#446305</td><td>056-01-0024</td></tr> <tr><td>#447697</td><td>056-01-0025</td></tr> </table> | #47691 | 056-01-0018 | #35058 | 056-01-0019 | #46300 | 056-01-0020 | #46300 | 056-01-0021 | #35066 | 056-01-0022 | #42623 | 056-01-0023 | #446305 | 056-01-0024 | #447697 | 056-01-0025 | 14) | <p>REQUEST BY SIZE</p>  | <p>45° Straight Grease Nipple , 1/8 " NPT(Taper thread) ,45 degrees 90° Straight Grease Nipple , 1/8 " NPT(Taper thread),90 degrees 45° Bend Grease Nipple 1/8" NPT (Taper thread) 90° Bend Grease Nipple 1/8 NPT (Taper thread)</p> |
| #47691 | 056-01-0018 | | | | | | | | | | | | | | | | | | | | |
| #35058 | 056-01-0019 | | | | | | | | | | | | | | | | | | | | |
| #46300 | 056-01-0020 | | | | | | | | | | | | | | | | | | | | |
| #46300 | 056-01-0021 | | | | | | | | | | | | | | | | | | | | |
| #35066 | 056-01-0022 | | | | | | | | | | | | | | | | | | | | |
| #42623 | 056-01-0023 | | | | | | | | | | | | | | | | | | | | |
| #446305 | 056-01-0024 | | | | | | | | | | | | | | | | | | | | |
| #447697 | 056-01-0025 | | | | | | | | | | | | | | | | | | | | |

| | | | | | | | | | | | | | | | | | | | | | | | |
|------------------------|---|---|-----------------|-------------|-----------------|-------------|-----------------|-------------|-----------------|-------------|-----------------|-------------|-----------------|-------------|-----------------|-------------|------------------------|--------------------|-----------------|-------------|-----|--|--|
| 15) |  | <table border="0"> <tr><td>BEARING Set 401</td><td>056-01-0026</td></tr> <tr><td>BEARING Set 403</td><td>056-01-0027</td></tr> <tr><td>BEARING Set 406</td><td>056-01-0028</td></tr> <tr><td>BEARING Set 413</td><td>056-01-0029</td></tr> <tr><td>BEARING Set 414</td><td>056-01-0030</td></tr> <tr><td>BEARING Set 415</td><td>056-01-0031</td></tr> <tr><td>BEARING Set 427</td><td>056-01-0032</td></tr> <tr><td>BEARING Set 429</td><td>056-01-0033</td></tr> <tr><td>BEARING Set 430</td><td>056-01-0034</td></tr> </table> | BEARING Set 401 | 056-01-0026 | BEARING Set 403 | 056-01-0027 | BEARING Set 406 | 056-01-0028 | BEARING Set 413 | 056-01-0029 | BEARING Set 414 | 056-01-0030 | BEARING Set 415 | 056-01-0031 | BEARING Set 427 | 056-01-0032 | BEARING Set 429 | 056-01-0033 | BEARING Set 430 | 056-01-0034 | 16) | <p>056-01-0035</p>  | <p>FLYWHEEL ASSY. , 15" CLUTCH 12 Mounting Bolts DETROIT DIESEL 23514177 series 60</p> |
| BEARING Set 401 | 056-01-0026 | | | | | | | | | | | | | | | | | | | | | | |
| BEARING Set 403 | 056-01-0027 | | | | | | | | | | | | | | | | | | | | | | |
| BEARING Set 406 | 056-01-0028 | | | | | | | | | | | | | | | | | | | | | | |
| BEARING Set 413 | 056-01-0029 | | | | | | | | | | | | | | | | | | | | | | |
| BEARING Set 414 | 056-01-0030 | | | | | | | | | | | | | | | | | | | | | | |
| BEARING Set 415 | 056-01-0031 | | | | | | | | | | | | | | | | | | | | | | |
| BEARING Set 427 | 056-01-0032 | | | | | | | | | | | | | | | | | | | | | | |
| BEARING Set 429 | 056-01-0033 | | | | | | | | | | | | | | | | | | | | | | |
| BEARING Set 430 | 056-01-0034 | | | | | | | | | | | | | | | | | | | | | | |

| | | | | | |
|-----|--|---|--|--|--|
| 17) | <p>056-01-0196</p>  | <p>EXHAUST CLAMP 5" EC50PL</p> <p>Automann 562.U3105SS Volvo:90358A&FG90358A</p> <p>Freightliner:ABP N35 50PLA&TCP A50AFE International:583-979-C Also suitable to Kenworth&Newstar</p> | | | |
|-----|--|---|--|--|--|

| | | | | |
|-----|---|---|--|--|
| 18) | <p>056-01-0037</p>  | <p>BRAKE SHOE, w/o LINING 4515Q #A1933222D2006</p> | <p>19)</p> <p>056-01-0038</p>  | <p>BRAKE SHOE, 4715 16 1/2"X6" Meritor:A3222-P-2200 Rivet Holes:24 Rivet Size:0.25" Size:10-9</p> |
| 20) | <p>056-01-0037S</p>  | <p>BRAKE SHOE, with LINING 4515Q #SR3014707QP #KSMA314 4707QP</p> | <p>21)</p> <p>056-01-0038S</p>  | <p>BRAKE SHOE, with LINING 4515Q 16.5"X6" Volvo:RCBKE4715QHD23 MACK:1000-BKE4715QHD23 Meritor:XKMG2L4715QP</p> |
| 22) | <p>056-01-0037K</p>  | <p>BRAKE SHOE, With LINING & R/KIT 4515Q</p> <p>Kit P.no:8000HD Rivet Size:0.25" Rivet Holes:32 Lining:#MA312</p> | <p>23)</p> <p>056-01-0038K</p>  | <p>BRAKE SHOE, with LINING & R/Kit 4715Q</p> <p>With Kit 8081 Lining:MA31 2</p> |

Diaphragms



MEMBRANS

| SR NO. | TRUSTTEC NO. | PART NO. | | TYPE | DESCRIPTION |
|--------|--------------|---------------|--|----------|--------------|
| 1 | 056-01-0039 | 897 120 492.4 | | Type 9" | Short Stroke |
| 2 | 056-01-0040 | 897 120 505.4 | | Type 12" | Short Stroke |
| 3 | 056-01-0041 | 897 120 510.4 | | Type 16" | Short Stroke |
| 4 | 056-01-0042 | 897 120 520.4 | | Type 20" | Short Stroke |
| 5 | 056-01-0043 | 897 120 530.4 | | Type 24" | Short Stroke |
| 6 | 056-01-0044 | 897 120 540.4 | | Type 30" | Short Stroke |
| 7 | 056-01-0045 | 897 120 550.4 | | Type 36" | Short Stroke |
| 8 | 056-01-0041L | 897 120 516.4 | | Type 16" | Long Stroke |
| 9 | 056-01-0042L | 897 120 526.4 | | Type 20" | Long Stroke |
| 10 | 056-01-0043L | 897 120 536.4 | | Type 24" | Long Stroke |
| 11 | 056-01-0044L | 897 120 546.4 | | Type 30" | Long Stroke |

Square Bend, Bulk

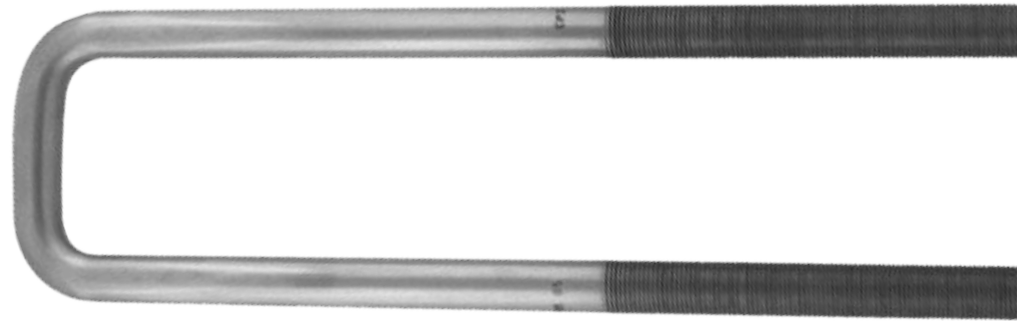

| SR NO. | TRUSTTEC NO. | SIZE Dia x Width x Length | | BEND | GRADE |
|--------|--------------|------------------------------|--|---------|-------|
| 1 | 056-01-0045 | 1-1/8" x 5-13/16" x 11" | | Sq Bend | Gr 8 |
| 2 | 056-01-0046 | 1-1/8" x 5-13/16" x 14" | | Sq Bend | Gr 8 |
| 3 | 056-01-0047 | 1-1/8" x 5-3/16" x 13-1/2" | | Sq Bend | Gr 8 |
| 4 | 056-01-0048 | 1-1/8" x 5-3/16" x 15-1/2" | | Sq Bend | Gr 8 |
| 5 | 056-01-0049 | 3/4" x 3-9/16" x 5" | | Sq Bend | Gr 8 |
| 6 | 056-01-0050 | 3/4" x 4-1/16" x 10" | | Sq Bend | Gr 8 |
| 7 | 056-01-0051 | 3/4" x 4-1/16" x 5" | | Sq Bend | Gr 8 |
| 8 | 056-01-0052 | 7/8" x 5-3/16" x 15-3/8" | | Sq Bend | Gr 8 |

Semi Round, Bulk

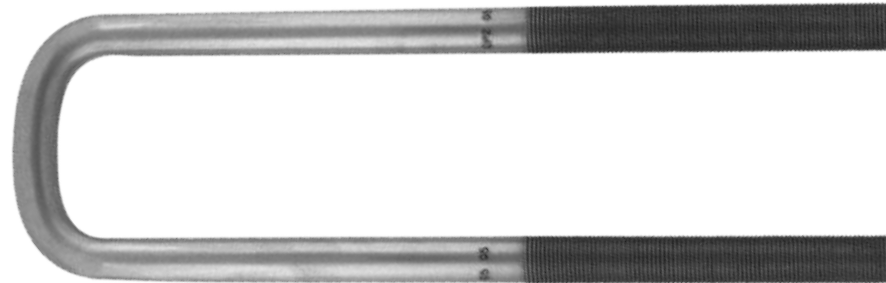

| SR NO. | TRUSTTEC NO. | SIZE Dia x Width x Length | | BEND | GRADE |
|--------|--------------|------------------------------|--|------------|-------|
| 1 | 056-01-0053 | 1" x 4-3/16" x 15-1/2" | | Semi Round | Gr 8 |
| 2 | 056-01-0054 | 1-1/4" x 4-1/16" x 16-1/4" | | Semi Round | Gr 8 |
| 3 | 056-01-0055 | 1-1/4" x 4-1/16" x 18" | | Semi Round | Gr 8 |
| 4 | 056-01-0056 | 1-1/4" x 4-1/16" x 19-1/4" | | Semi Round | Gr 8 |
| 5 | 056-01-0057 | 3/4" x 3-9/16" x 15" | | Semi Round | Gr 8 |
| 6 | 056-01-0058 | 3/4" x 4-1/16" x 10" | | Semi Round | Gr 8 |
| 7 | 056-01-0059 | 7/8" x 3-1/16" x 19" | | Semi Round | Gr 8 |
| 8 | 056-01-0060 | 7/8" x 3 9/16" x 15 3/16" | | Semi Round | Gr 8 |

Round, Bulk

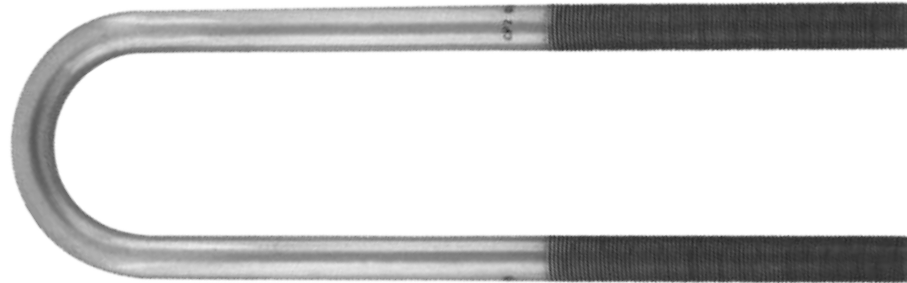

| SR NO. | TRUSTTEC NO. | SIZE Dia x Width x Length | BEND | GRADE |
|--------|--------------|------------------------------|-------|-------|
| 1 | 056-01-0061 | 1" x 5-1/16" x 12-3/4" | Round | Gr 8 |
| 2 | 056-01-0062 | 1" x 5-3/16" x 10-1/2" | Round | Gr 8 |
| 3 | 056-01-0063 | 1-1/8" x 5-13/16" x 16" | Round | Gr 8 |
| 4 | 056-01-0064 | 3/4" x 3-1/16" x 10" | Round | Gr 8 |
| 5 | 056-01-0065 | 3/4" x 3-1/16" x 12" | Round | Gr 8 |
| 6 | 056-01-0066 | 3/4" x 3-1/16" x 14" | Round | Gr 8 |
| 7 | 056-01-0067 | 3/4" x 3-1/16" x 16" | Round | Gr 8 |
| 8 | 056-01-0068 | 3/4" x 3-1/16" x 18" | Round | Gr 8 |
| 9 | 056-01-0069 | 3/4" x 4-1/16" x 10" | Round | Gr 8 |
| 10 | 056-01-0070 | 3/4" x 4-1/16" x 12" | Round | Gr 8 |
| 11 | 056-01-0071 | 3/4" x 5-1/16" x 7-1/2" | Round | Gr 8 |
| 12 | 056-01-0072 | 5/8" x 5-1/16" x 7-3/4" | Round | Gr 8 |
| 13 | 056-01-0073 | 7/8" x 3-1/16" x 10" | Round | Gr 8 |
| 14 | 056-01-0074 | 7/8" x 3-1/16" x 11" | Round | Gr 8 |
| 15 | 056-01-0075 | 7/8" x 3-1/16" x 12" | Round | Gr 5 |
| 16 | 056-01-0076 | 7/8" x 3-1/16" x 12" | Round | Gr 8 |
| 17 | 056-01-0077 | 7/8" x 3-1/16" x 12-1/4" | Round | Gr 8 |
| 18 | 056-01-0078 | 7/8" x 3-1/16" x 13" | Round | Gr 5 |
| 19 | 056-01-0079 | 7/8" x 3-1/16" x 13" | Round | Gr 8 |
| 20 | 056-01-0080 | 7/8" x 3-1/16" x 14" | Round | Gr 5 |

Round, Bulk

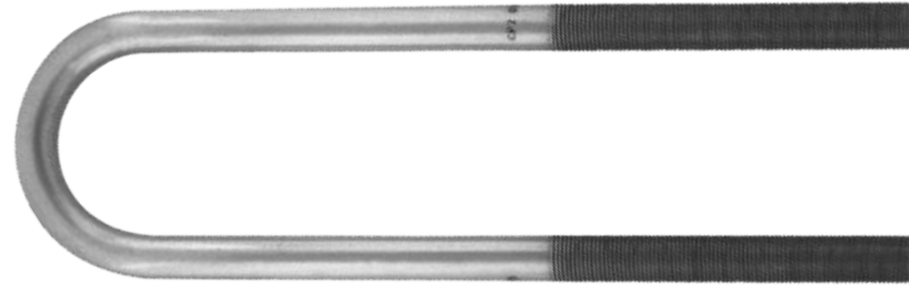

| SR NO. | TRUSTTEC NO. | SIZE Dia x Width x Length | BEND | GRADE |
|--------|--------------|------------------------------|-------|-------|
| 21 | 056-01-0081 | 7/8" x 3-1/16" x 14" | Round | Gr 8 |
| 22 | 056-01-0082 | 7/8" x 3-1/16" x 15" | Round | Gr 8 |
| 23 | 056-01-0083 | 7/8" x 3-1/16" x 16" | Round | Gr 5 |
| 24 | 056-01-0084 | 7/8" x 3-1/16" x 18" | Round | Gr 5 |
| 25 | 056-01-0085 | 7/8" x 3-1/16" x 18" | Round | Gr 8 |
| 26 | 056-01-0086 | 7/8" x 3-9/16" x 14" | Round | Gr 5 |
| 27 | 056-01-0087 | 7/8" x 3-9/16" x 14" | Round | Gr 5 |
| 28 | 056-01-0088 | 7/8" x 3-9/16" x 14" | Round | Gr 8 |
| 29 | 056-01-0089 | 7/8" x 4-1/16" x 10" | Round | Gr 8 |
| 30 | 056-01-0090 | 7/8" x 4-1/16" x 16" | Round | Gr 8 |
| 31 | 056-01-0091 | 7/8" x 5-1/16" x 12" | Round | Gr 5 |
| 32 | 056-01-0092 | 7/8" x 5-1/16" x 12" | Round | Gr 8 |
| 33 | 056-01-0093 | 7/8" x 5-1/16" x 14" | Round | Gr 5 |
| 34 | 056-01-0094 | 7/8" x 5-1/16" x 14" | Round | Gr 8 |
| 35 | 056-01-0095 | 7/8" x 5-1/16" x 15" | Round | Gr 5 |
| 36 | 056-01-0096 | 7/8" x 5-1/16" x 16" | Round | Gr 5 |
| 37 | 056-01-0097 | 7/8" x 5-1/16" x 16" | Round | Gr 8 |
| 38 | 056-01-0098 | 7/8" x 5-1/16" x 16" | Round | Gr 8 |
| 39 | 056-01-0099 | 7/8" x 5-1/16" x 18" | Round | Gr 5 |
| 40 | 056-01-0100 | 7/8" x 6-1/16" x 8-1/4" | Round | Gr 8 |

End Threaded Rod With Center Line



| SR NO. | TRUSTTEC NO. | SIZE Dia x Length | GRADE |
|--------|--------------|----------------------|-------|
| 1 | 056-01-0101 | 5/8" x 24" | Gr 8 |
| 2 | 056-01-0102 | 5/8" x 26" | Gr 8 |
| 3 | 056-01-0103 | 5/8" x 28" | Gr 8 |
| 4 | 056-01-0104 | 5/8" x 30" | Gr 8 |
| 5 | 056-01-0105 | 5/8" x 32" | Gr 8 |
| 6 | 056-01-0106 | 5/8" x 34" | Gr 8 |
| 7 | 056-01-0107 | 5/8" x 36" | Gr 8 |
| 8 | 056-01-0108 | 5/8" x 38" | Gr 8 |
| 9 | 056-01-0109 | 5/8" x 40" | Gr 8 |
| 10 | 056-01-0110 | 5/8" x 42" | Gr 8 |
| 11 | 056-01-0111 | 5/8" x 48" | Gr 8 |
| 13 | 056-01-0112 | 3/4" x 12" | Gr 8 |
| 14 | 056-01-0113 | 3/4" x 14" | Gr 8 |
| 15 | 056-01-0114 | 3/4" x 18" | Gr 8 |
| 16 | 056-01-0115 | 3/4" x 20" | Gr 8 |
| 17 | 056-01-0116 | 3/4" x 22" | Gr 8 |
| 18 | 056-01-0117 | 3/4" x 26" | Gr 8 |
| 19 | 056-01-0118 | 3/4" x 38" | Gr 8 |
| 20 | 056-01-0119 | 3/4" x 40" | Gr 8 |
| 21 | 056-01-0120 | 3/4" x 42" | Gr 8 |

End Threaded Rod With Center Line



| SR NO. | TRUSTTEC NO. | SIZE Dia x Length | GRADE |
|--------|--------------|----------------------|-------|
| 22 | 056-01-0121 | 3/4" x 44" | Gr 8 |
| 23 | 056-01-0122 | 3/4" x 16" | Gr 8 |
| 24 | 056-01-0123 | 3/8" x 18" | Gr 8 |
| 25 | 056-01-0124 | 7/8" x 20" | Gr 8 |
| 26 | 056-01-0125 | 7/8" x 22" | Gr 8 |
| 27 | 056-01-0126 | 7/8" x 24" | Gr 8 |
| 28 | 056-01-0127 | 7/8" x 26" | Gr 8 |
| 29 | 056-01-0128 | 7/8" x 28" | Gr 8 |
| 30 | 056-01-0129 | 7/8" x 30" | Gr 8 |
| 31 | 056-01-0130 | 7/8" x 32" | Gr 8 |
| 32 | 056-01-0131 | 7/8" x 34" | Gr 8 |
| 33 | 056-01-0132 | 7/8" x 36" | Gr 8 |
| 34 | 056-01-0133 | 7/8" x 38" | Gr 8 |
| 35 | 056-01-0134 | 7/8" x 40" | Gr 8 |
| 36 | 056-01-0135 | 7/8" x 42" | Gr 8 |
| 37 | 056-01-0136 | 7/8" x 48" | Gr 8 |
| 38 | 056-01-0137 | 7/8" x 54" | Gr 8 |
| 39 | 056-01-0138 | 1" x 28" | Gr 8 |
| 40 | 056-01-0139 | 1" x 30" | Gr 8 |
| 41 | 056-01-0140 | 1" x 32" | Gr 8 |

End Threaded Rod With Center Line



| SR NO. | TRUSTTEC NO. | SIZE Dia x Length | | GRADE | |
|--------|--------------|----------------------|--|-------|--|
| 42 | 056-01-0141 | 1" x 36" | | Gr 8 | |
| 43 | 056-01-0142 | 1/2" x 14" | | Gr 5 | |
| 44 | 056-01-0143 | 1/2" x 16" | | Gr 5 | |
| 45 | 056-01-0144 | 1/2" x 18" | | Gr 5 | |
| 46 | 056-01-0145 | 1/2" x 20" | | Gr 5 | |
| 47 | 056-01-0146 | 1/2" x 22" | | Gr 5 | |
| 48 | 056-01-0147 | 1/2" x 24" | | Gr 5 | |
| 49 | 056-01-0148 | 1/2" x 30" | | Gr 5 | |
| 50 | 056-01-0149 | 9/16" x 14" | | Gr 5 | |
| 51 | 056-01-0150 | 9/16" x 16" | | Gr 5 | |
| 52 | 056-01-0151 | 9/16" x 20" | | Gr 5 | |
| 53 | 056-01-0152 | 9/16" x 22" | | Gr 5 | |
| | | | | | |
| | | | | | |
| | | | | | |
| | | | | | |
| | | | | | |
| | | | | | |
| | | | | | |
| | | | | | |

Spring Center Bolt, High Head

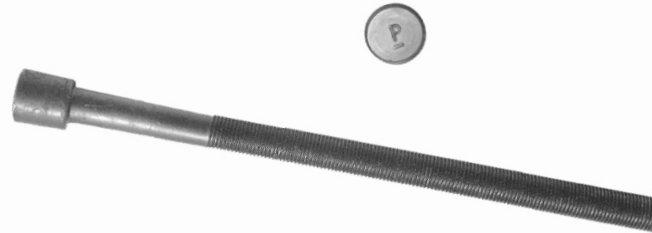

| SR NO. | TRUSTTEC NO. | SIZE Dia x Length | | GRADE | Thread Length |
|--------|--------------|----------------------|--|-------|------------------|
| 1 | 056-01-0153 | 3/8"-24 x 6" | | Gr 2 | 5 1/5" - 5 1/2" |
| 2 | 056-01-0154 | 3/8"-24 x 8" | | Gr 2 | 6 1/5" - 6 1/2" |
| 3 | 056-01-0155 | 3/8"-24 x 10" | | Gr 2 | 6 1/5" - 6 1/2" |
| 4 | 056-01-0156 | 7/16"-20 x 6" | | Gr 2 | 5 1/5" - 5 1/2" |
| 5 | 056-01-0157 | 7/16"-20 x 8" | | Gr 2 | 6 1/5" - 6 1/2" |
| 6 | 056-01-0158 | 7/16"-20 x 10" | | Gr 2 | 6 1/5" - 6 1/2" |
| 7 | 056-01-0159 | 1/2"-20 x 6" | | Gr 2 | 5 1/5" - 5 1/2" |
| 8 | 056-01-0160 | 1/2"-20 x 8" | | Gr 2 | 6 1/5" - 6 1/2" |
| 9 | 056-01-0161 | 1/2"-20 x 10" | | Gr 2 | 6 1/5" - 6 1/2" |
| 10 | 056-01-0162 | 9/16"-18 x 6" | | Gr 2 | 5 1/5" - 5 1/2" |
| 11 | 056-01-0163 | 9/16"-18 x 8" | | Gr 2 | 6 1/5" - 6 1/2" |
| 12 | 056-01-0164 | 9/16"-18 x 10" | | Gr 2 | 6 1/5" - 6 1/2" |
| 13 | 056-01-0165 | 9/16"-18 x 12" | | Gr 2 | 8 1/2" - 8 7/10" |
| 14 | 056-01-0166 | 1/2"-20 x 12" | | Gr 2 | --- |
| | | | | | |
| | | | | | |
| | | | | | |
| | | | | | |
| | | | | | |
| | | | | | |

Spring Center Bolt

| SR NO. | TRUSTTEC NO. | SIZE Dia x Length | GRADE | Thread Length |
|--------|--------------|----------------------|-------|------------------|
| 1 | 056-01-0167 | 5/16"-24 x 3" | Gr 2 | 2 1/2" - 2 7/10" |
| 2 | 056-01-0168 | 5/16"-24 x 3-1/2" | Gr 2 | 2 3/4" - 3" |
| 3 | 056-01-0169 | 5/16"-24 x 4" | Gr 2 | 3 1/5" - 3 1/2" |
| 4 | 056-01-0170 | 5/16"-24 x 5" | Gr 2 | 3 1/5" - 3 1/2" |
| 5 | 056-01-0171 | 5/16"-24 x 6" | Gr 2 | 5 1/5" - 5 1/2" |
| 6 | 056-01-0172 | 5/16"-24 x 8" | Gr 2 | 6 1/5" - 6 1/2" |
| 7 | 056-01-0173 | 3/8"-24 x 4" | Gr 2 | 3 1/5" - 3 1/2" |
| 8 | 056-01-0174 | 3/8"-24 x 5" | Gr 2 | 3 1/5" - 3 1/2" |
| 9 | 056-01-0175 | 3/8"-24 x 6" | Gr 2 | 5 1/5" - 5 1/2" |
| 10 | 056-01-0176 | 3/8"-24 x 7" | Gr 2 | --- |
| 11 | 056-01-0177 | 3/8"-24 x 8" | Gr 2 | 6 1/5" - 6 1/2" |
| 12 | 056-01-0178 | 3/8"-24 x 10" | Gr 2 | 6 1/5" - 6 1/2" |
| 13 | 056-01-0179 | 3/8"-24 x 12" | Gr 2 | 8 1/2" - 8 7/10" |
| 14 | 056-01-0180 | 7/16"-20 x 4" | Gr 2 | 3 1/5" - 3 1/2" |
| 15 | 056-01-0181 | 7/16"-20 x 5" | Gr 2 | 5 1/5" - 5 1/2" |
| 16 | 056-01-0182 | 7/16"-20 x 6" | Gr 2 | --- |
| 17 | 056-01-0183 | 7/16"-20 x 7" | Gr 2 | 6 1/5" - 6 1/2" |
| 18 | 056-01-0184 | 7/16"-20 x 8" | Gr 2 | 6 1/5" - 6 1/2" |
| 19 | 056-01-0185 | 7/16"-20 x 10" | Gr 2 | 8 1/2" - 8 7/10" |
| 20 | 056-01-0186 | 7/16"-20 x 12" | Gr 2 | 3 1/5" - 3 1/2" |

Spring Center Bolt

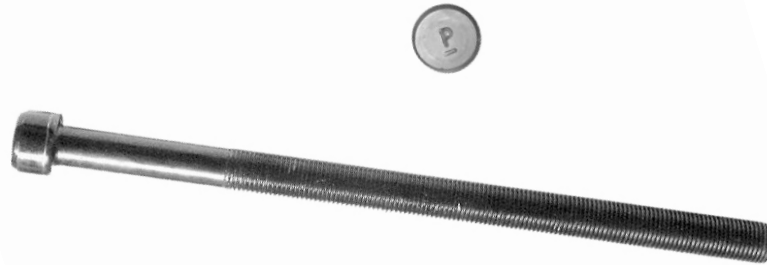

| SR NO. | TRUSTTEC NO. | SIZE Dia x Length | | GRADE | Thread Length |
|--------|--------------|----------------------|--|-------|------------------|
| 21 | 056-01-0187 | 1/2"-20 x 4" | | Gr 2 | 3 1/5" - 3 1/2" |
| 22 | 056-01-0188 | 1/2"-20 x 5" | | Gr 2 | 3 1/5" - 3 1/2" |
| 23 | 056-01-0189 | 1/2"-20 x 6" | | Gr 2 | 5 1/5" - 5 1/2" |
| 24 | 056-01-0190 | 1/2"-20 x 7" | | Gr 2 | --- |
| 25 | 056-01-0191 | 1/2"-20 x 8" | | Gr 2 | 6 1/5" - 6 1/2" |
| 26 | 056-01-0192 | 1/2"-20 x 10" | | Gr 2 | 6 1/5" - 6 1/2" |
| 27 | 056-01-0193 | 1/2"-20 x 12" | | Gr 2 | 8 1/2" - 8 7/10" |
| 28 | 056-01-0194 | 5/8"-18 x 8" | | Gr 2 | 6 1/5" - 6 1/2" |
| 29 | 056-01-0195 | 5/8"-18 x 10" | | Gr 2 | 6 1/5" - 6 1/2" |
| 30 | 056-01-0197 | 5/8"-18 x 12" | | Gr 2 | 8 1/2" - 8 7/10" |
| | | | | | |
| | | | | | |
| | | | | | |
| | | | | | |
| | | | | | |
| | | | | | |
| | | | | | |
| | | | | | |
| | | | | | |
| | | | | | |